

1



X-ray applications and accelerator physics for the Cornell ERL



Georg H. Hoffstaetter
Cornell Physics Dep. / CLASSE

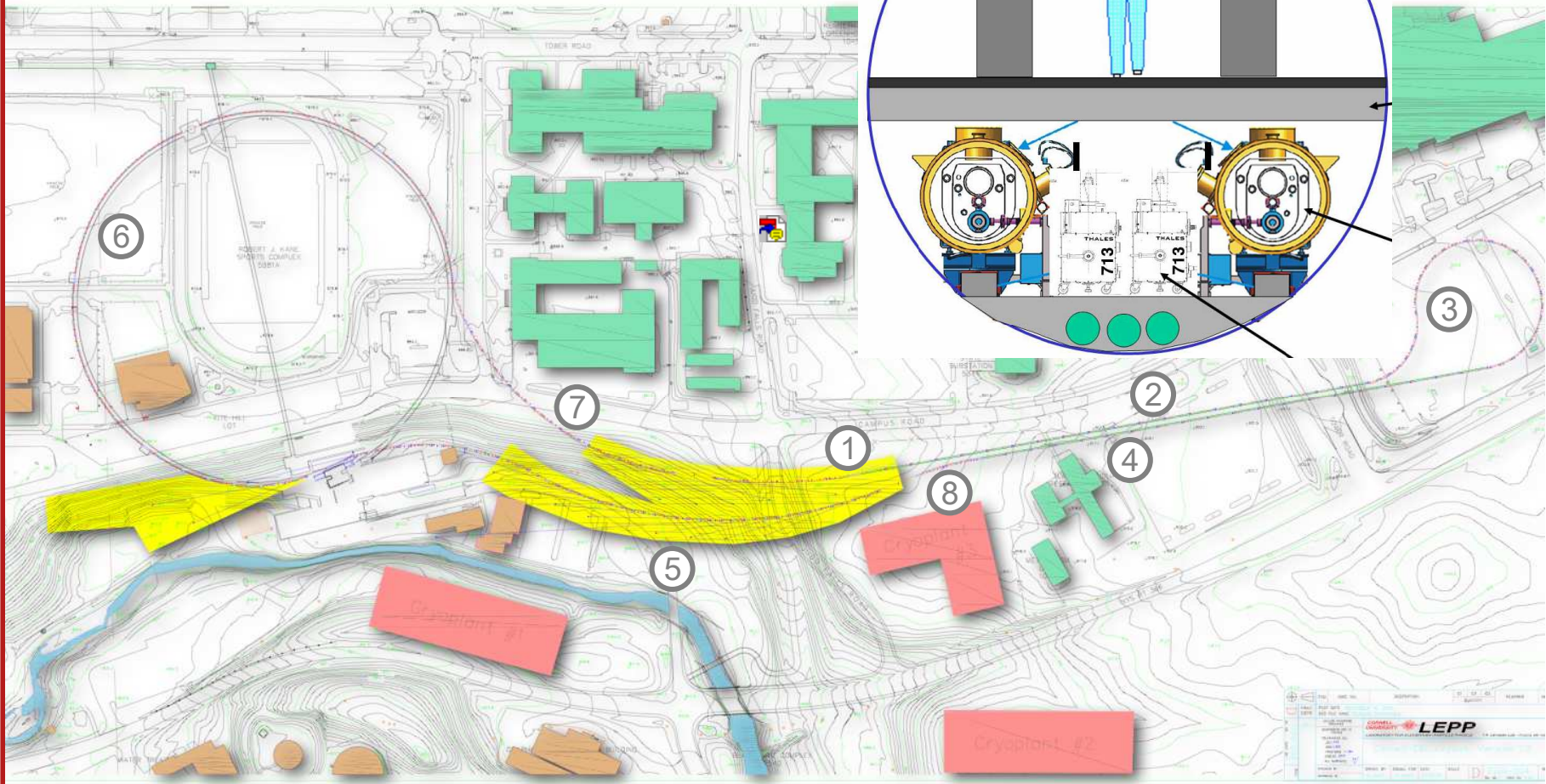
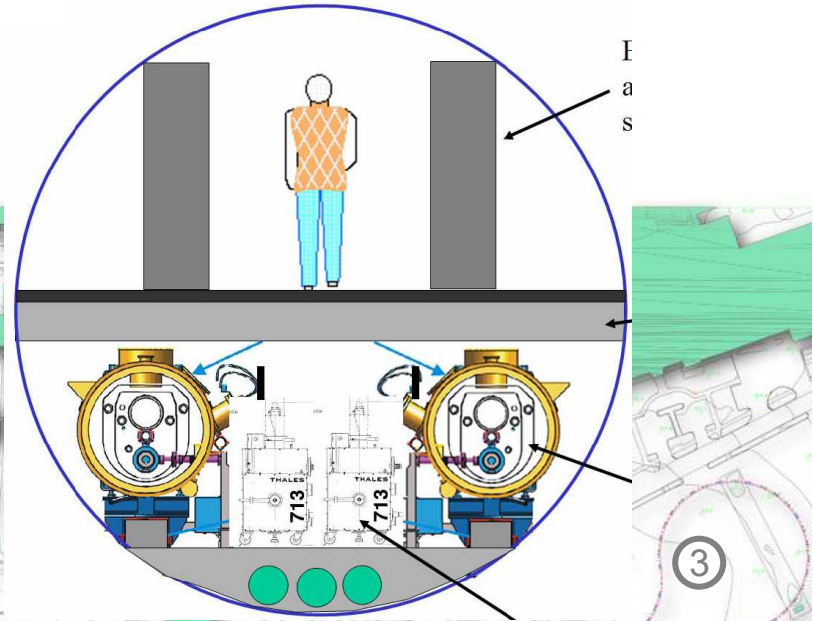



Overview



- Principle and history of ERLs
- How good of an X-ray source could an ERL be?
- What could it do?
- What remains challenging and what challenges are being addressed?



Principle of an X-ray ERL



X-ray analysis with highest resolution in space and time:

$$5\text{GV} \cdot 100\text{mA} = 0.5\text{GW}$$

(good size power plant)

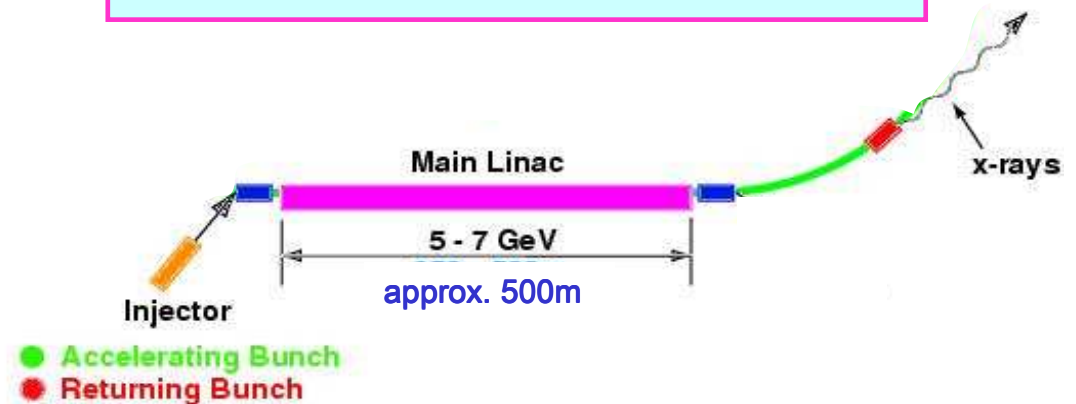

Challenges:

- Low emittance, high current creation
- Emittance preservation
- Beam stability at insertion devices
- Accelerator design
- Component properties, e.g. SRF

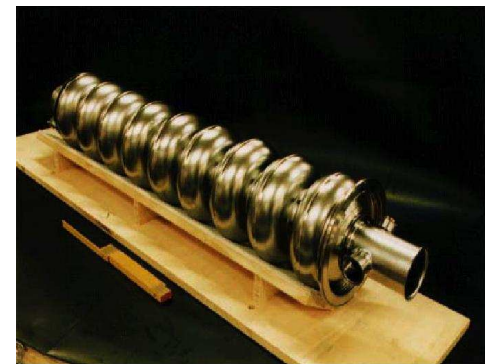



Principle of an X-ray ERL



X-ray analysis with highest resolution in space and time:

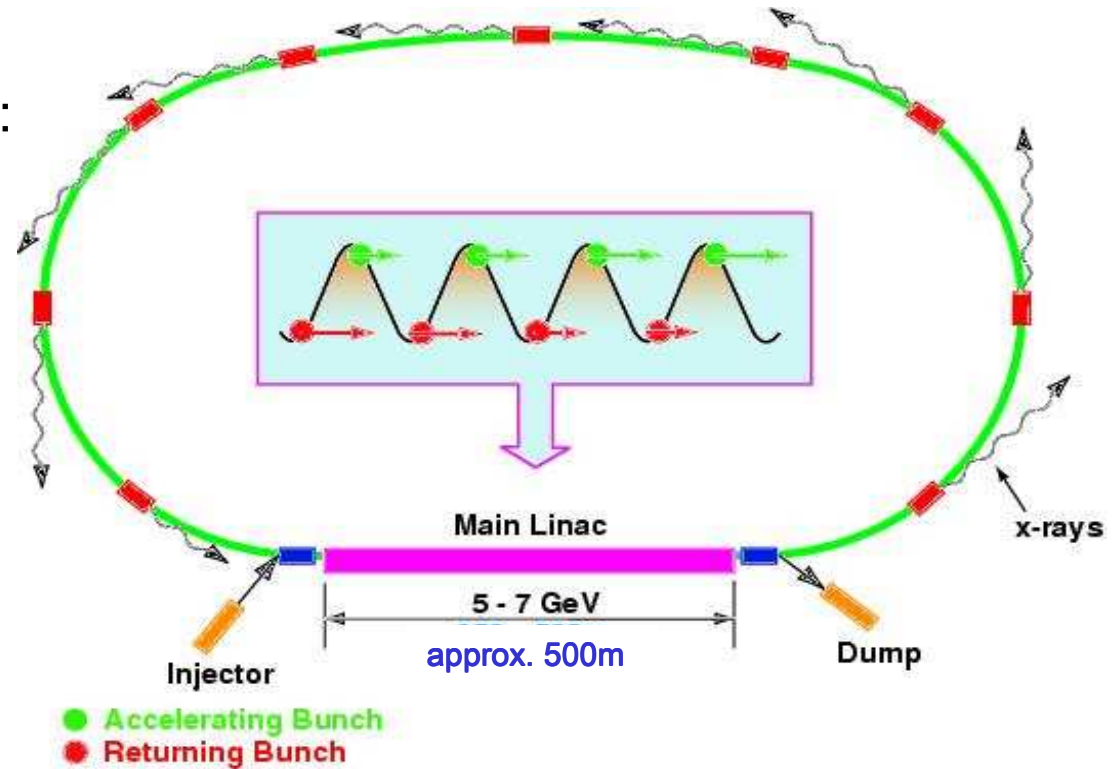

Challenges:

- Low emittance, high current creation
- Emittance preservation
- Beam stability at insertion devices
- Accelerator design
- Component properties, e.g. SRF

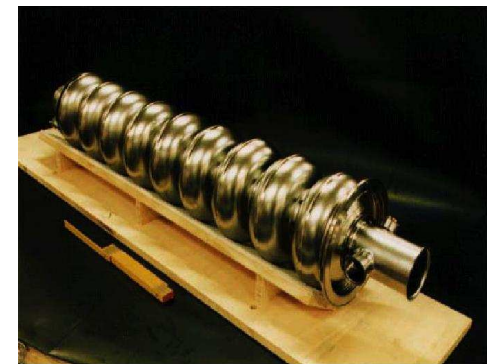



Cornell ERL

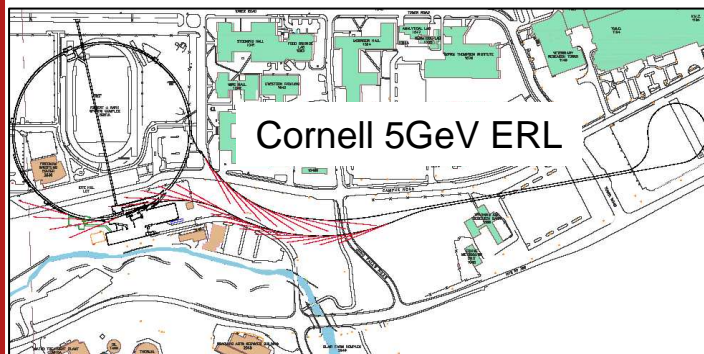



Cornell / KEK / JAEA ERLs

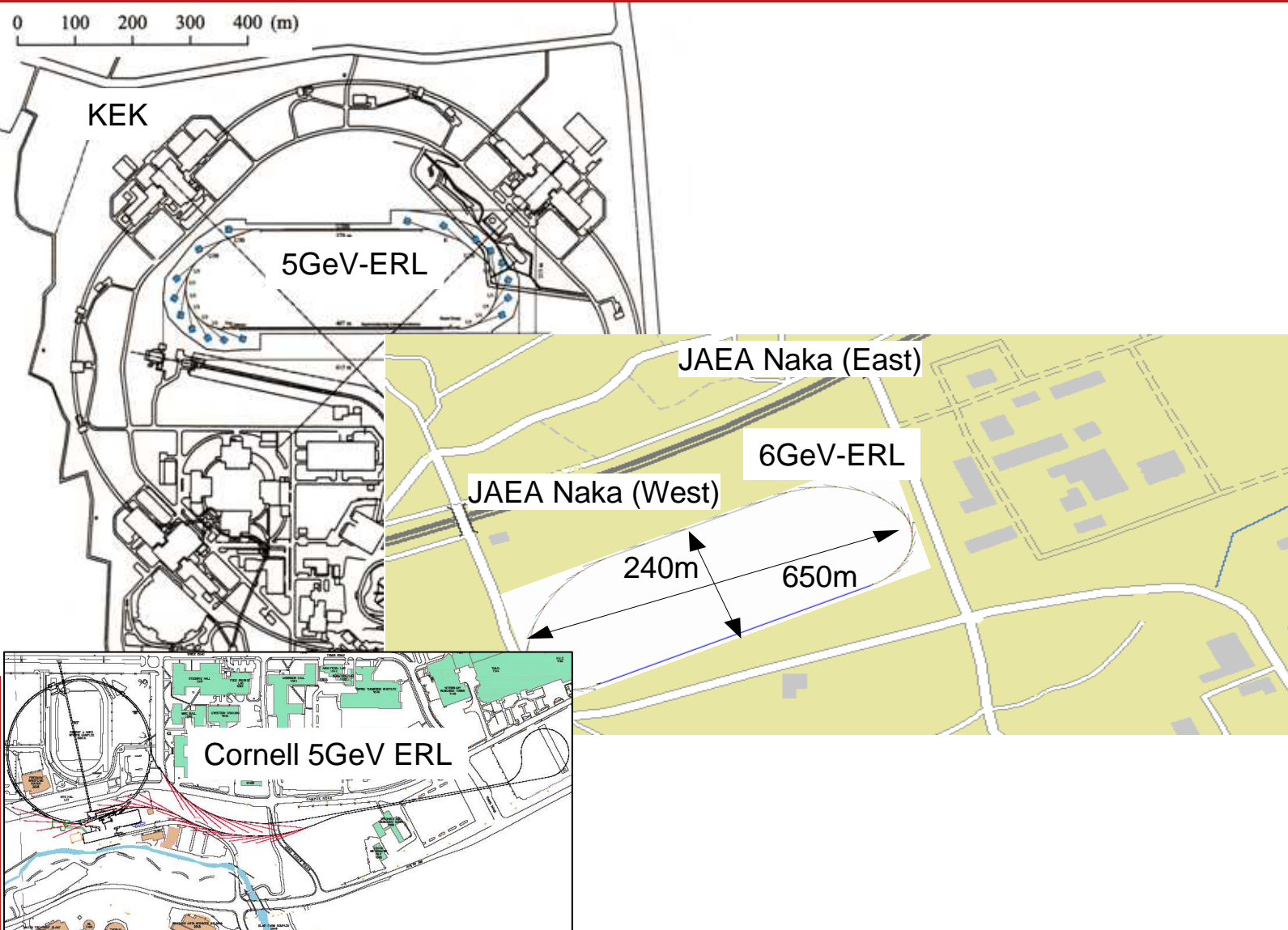



Cornell / KEK / JAEA / APS ERLs

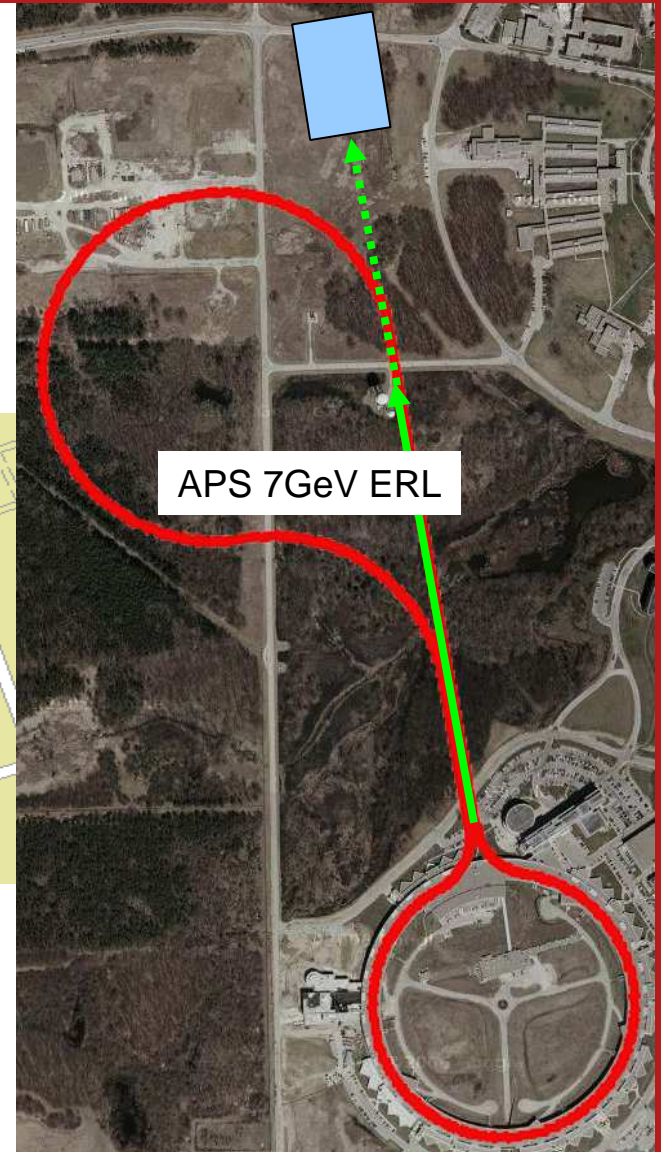
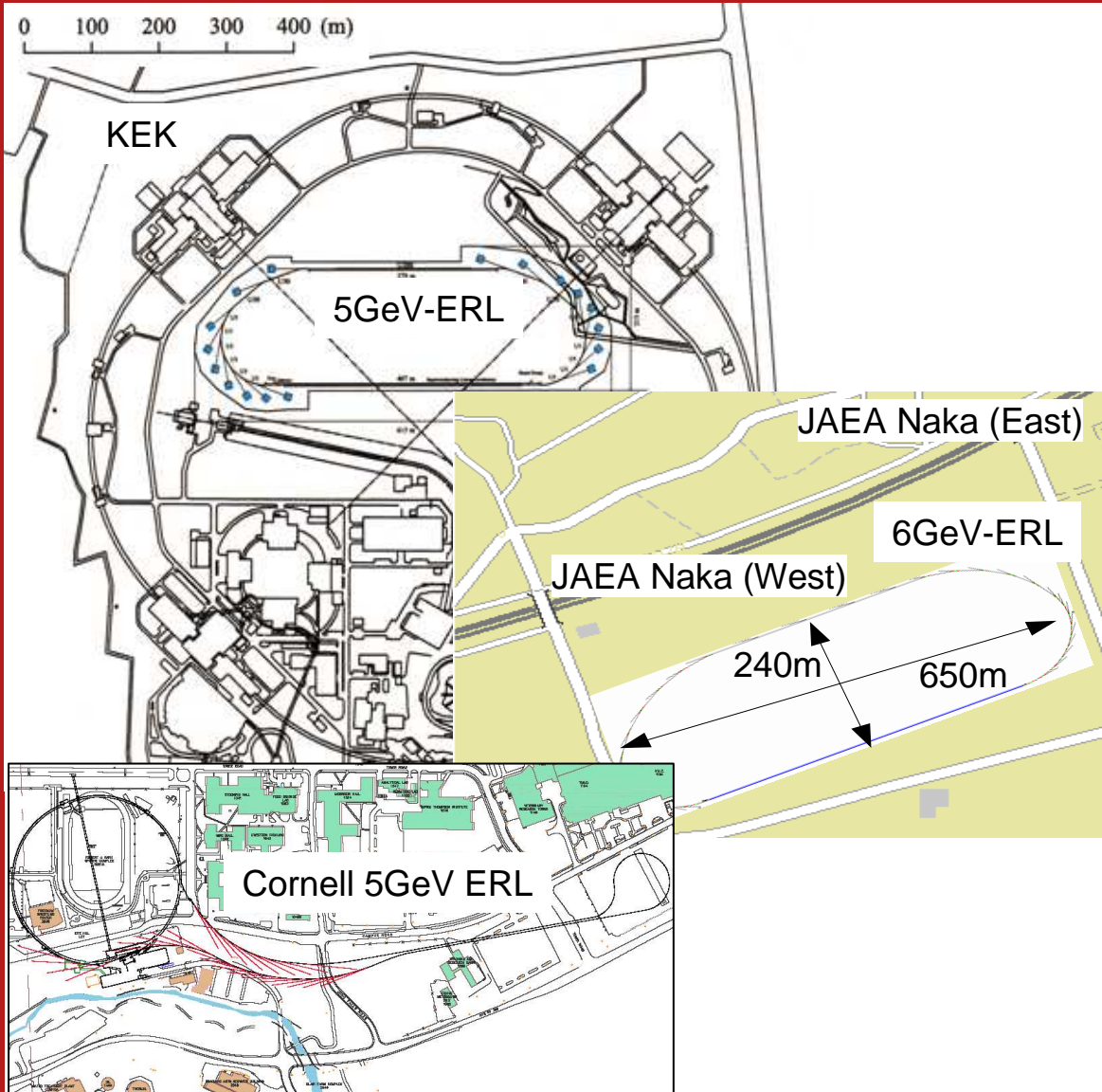



The injector: goals for the ERL



	Energy recovered modes			One pass	
Modes:	(A) Flux	(B) Coherence	(C) Short-Pulse	(D) High charge	Units
Energy	5	5	5	2.5	GeV
Current	100	25	100	0.1	mA
Bunch charge	77	19	77	1000	pC
Repetition rate	1300	1300	1300	0.1	MHz
Norm. emittance	0.3	0.08	1	5.0	mm mrad
Geom. emittance	31	8.2	103	1022	pm
Rms bunch length	2000	2000	100	50	fs
Relative energy spread	0.2	0.2	1	3	10^{-3}
Beam power	500	125	500	0.25	MW
Beam loss	< 1	< 1	< 1	<1	micro A



Advantages of ERL beams



Transverse emittance reduction:

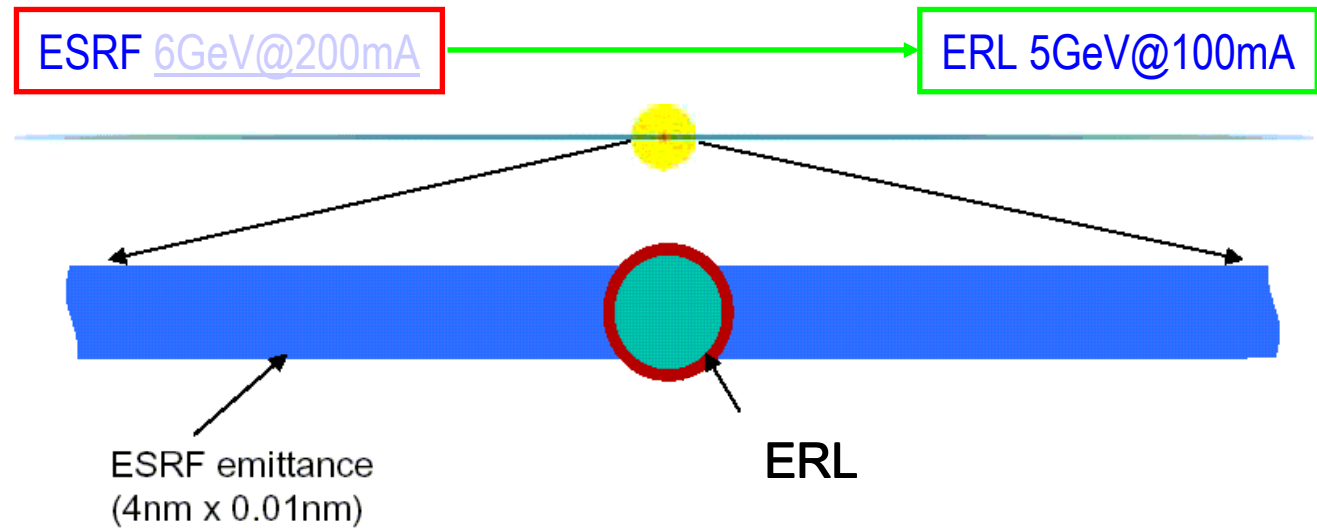

Bunch-length reduction:

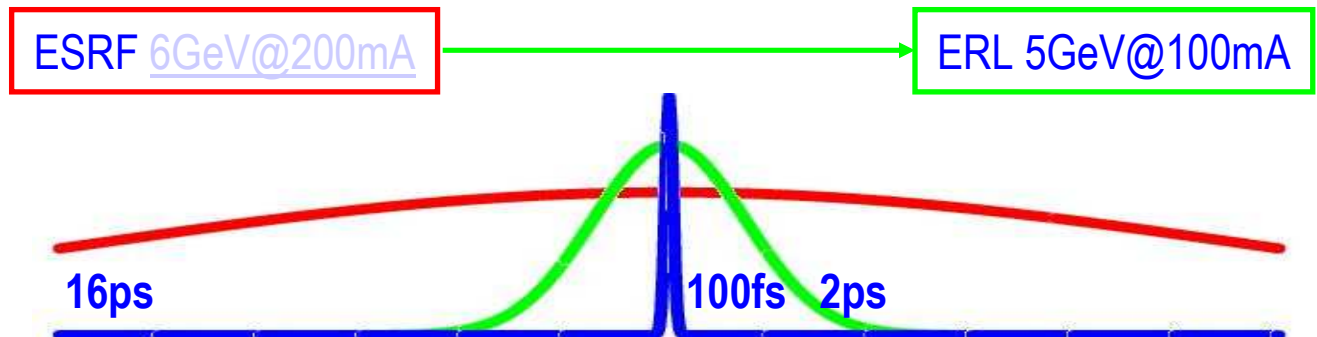



Smaller Beams and more Coherence



CLASSE

- Coherent x-ray diffraction imaging
- It would, in principle, allow atomic resolution imaging on non-crystalline materials.
- This type of experiments is completely limited by coherent flux.

Factor 100 more coherent flux for ERL
for same x-rays, or provide coherence for
harder x-rays

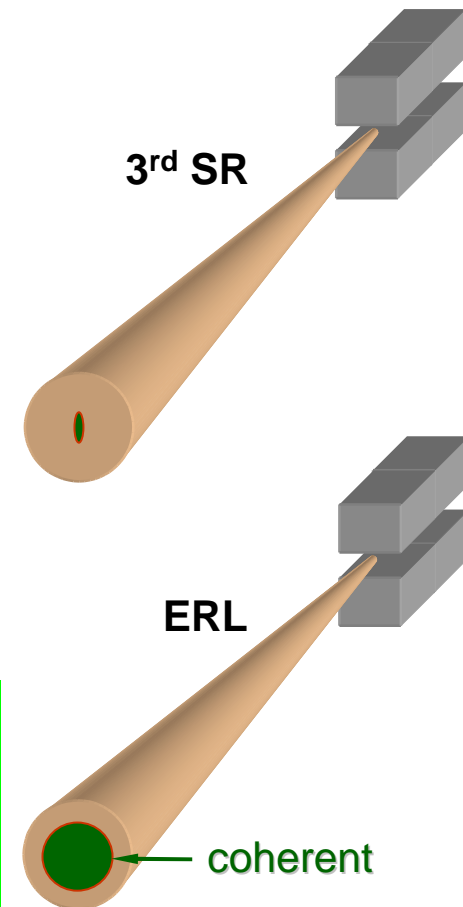



How large is the advantage of ERLs ?



CLASSE

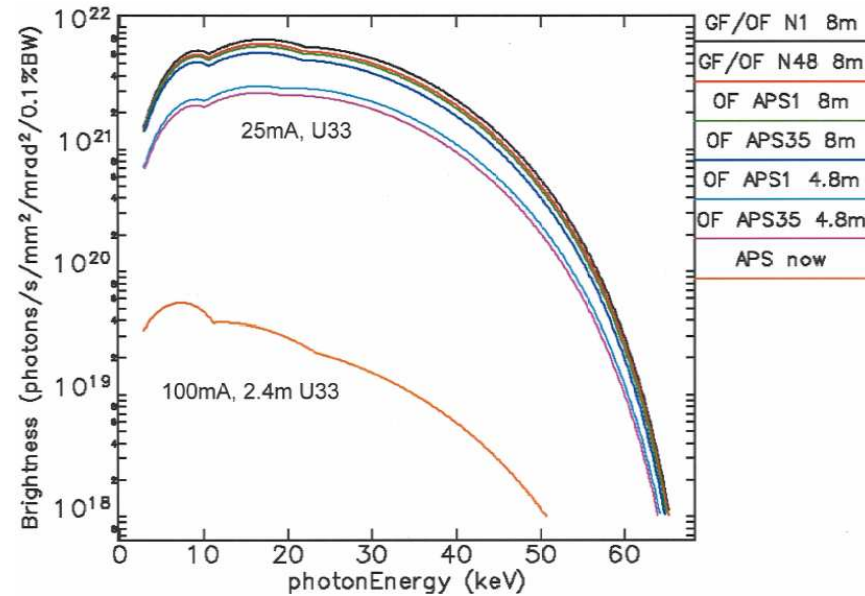
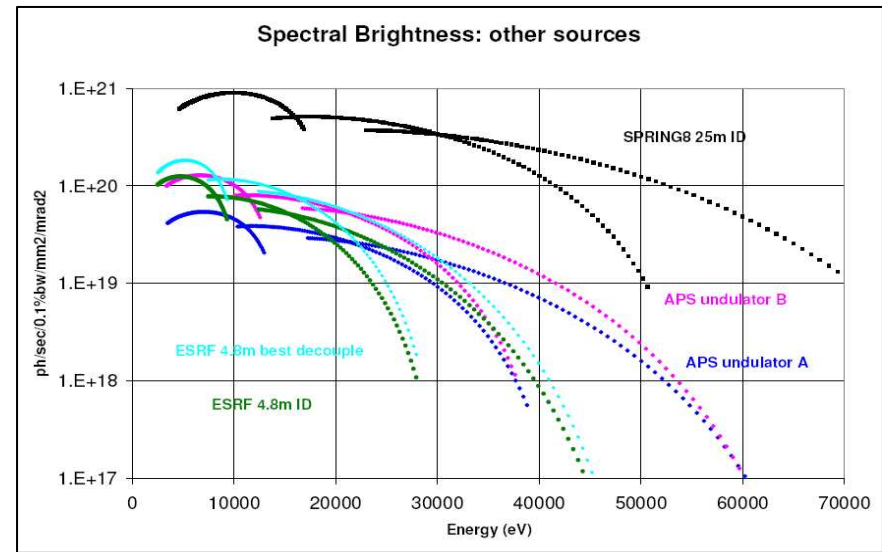
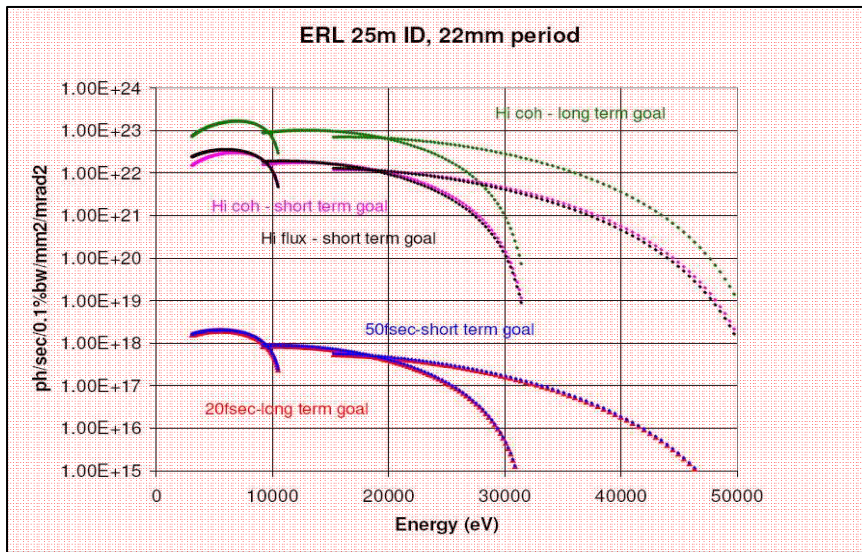



ERL workshops on areas of opportunity



CLASSE

1	nanoprobe	spot $\leq 1\text{nm}$
2	timing experiments	$\tau \sim 1\text{ ps}$ flexible pulse structure
3	hard x-ray coherent scattering (XPCS)	diffraction limited at 10KeV
4	soft x-ray coherent scattering	
5	high energy scattering	$E \gg 10\text{ KeV}$ (Compton, PDF)
6	coherent imaging	



Microprobe: higher resolution from narrower x-ray beams

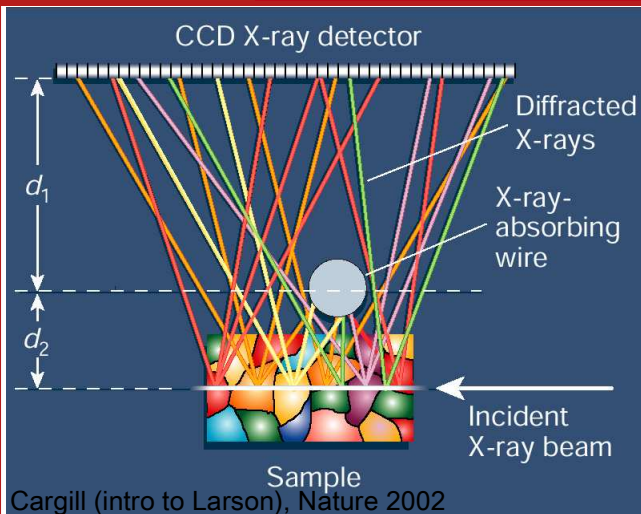

Differential-Aperture X-ray Microscopy (DAXM)

- Smaller beams lead to better spatial resolution (currently sub μm)

ERL: smaller area

Orientation of crystals and Stress and strain in crystals

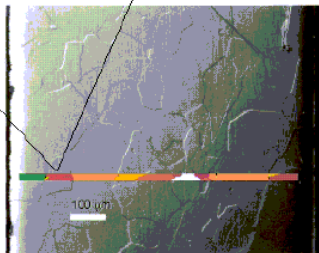
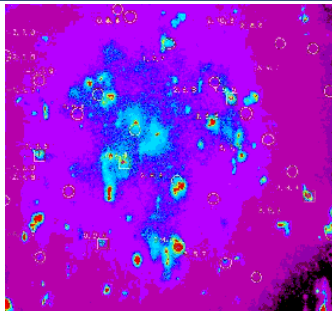

Ben Larson (2000), ERL science workshop, Cornell

3-D Studies of Structure

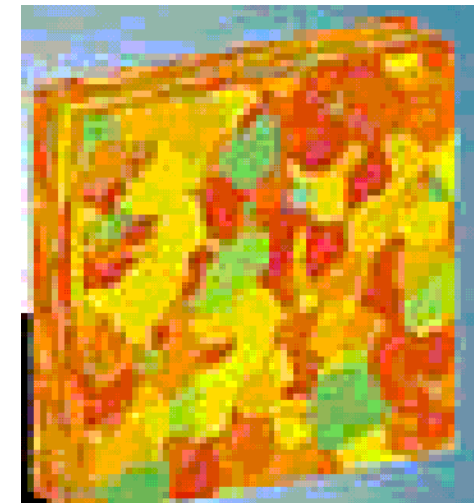



High Pressure: Materials, Engineering, Geological and Space Sciences.

J. B. Parise, H.- K. Mao, and R. Hemley
at ERL Workshop (2000)

- HP experiments for μm sample are brightness-limited. Time resolved experiments for plasticity, rheology measurements, phase transitions, etc. are especially photon starved.
- Higher P \Rightarrow smaller samples.
- No ideal pressurization medium \Rightarrow need to scan sample.
- Peak-to-background critical.
- ERL will greatly extend pressures and samples that can be studied.

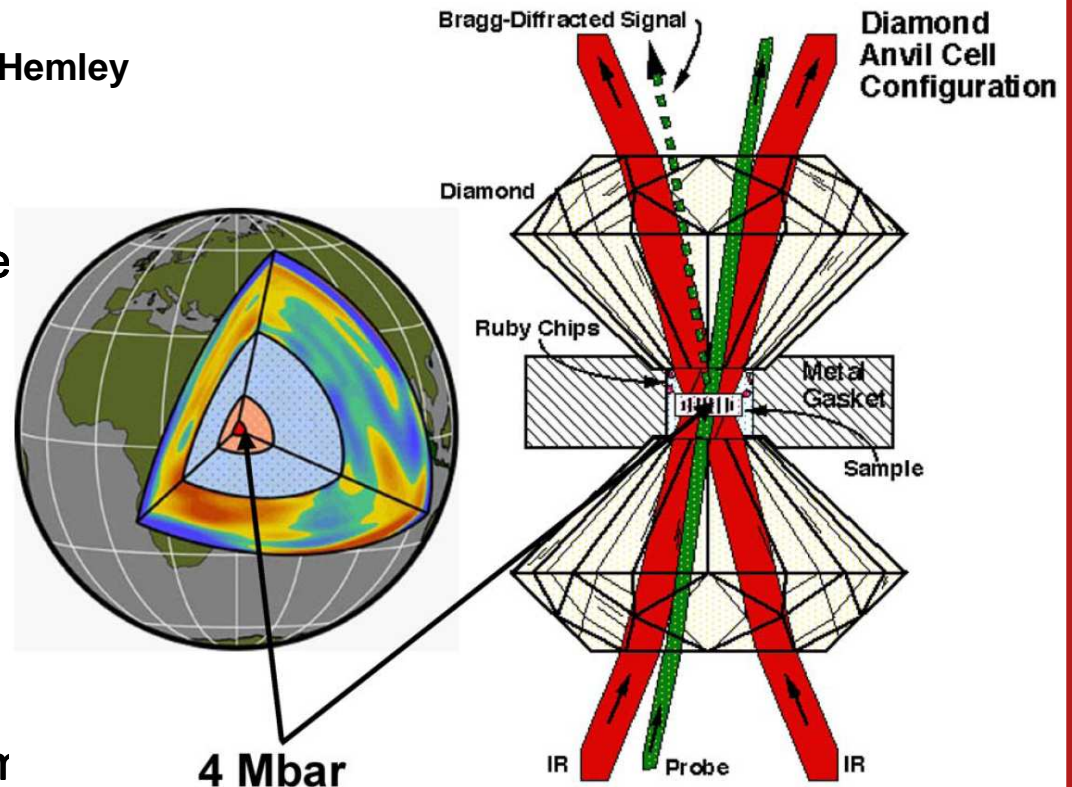

Parise, Hemley & Mao



High pressure in carbon nanotubes



CLASSE

Up to 1600GPa
with multi-wall
nanotubes.

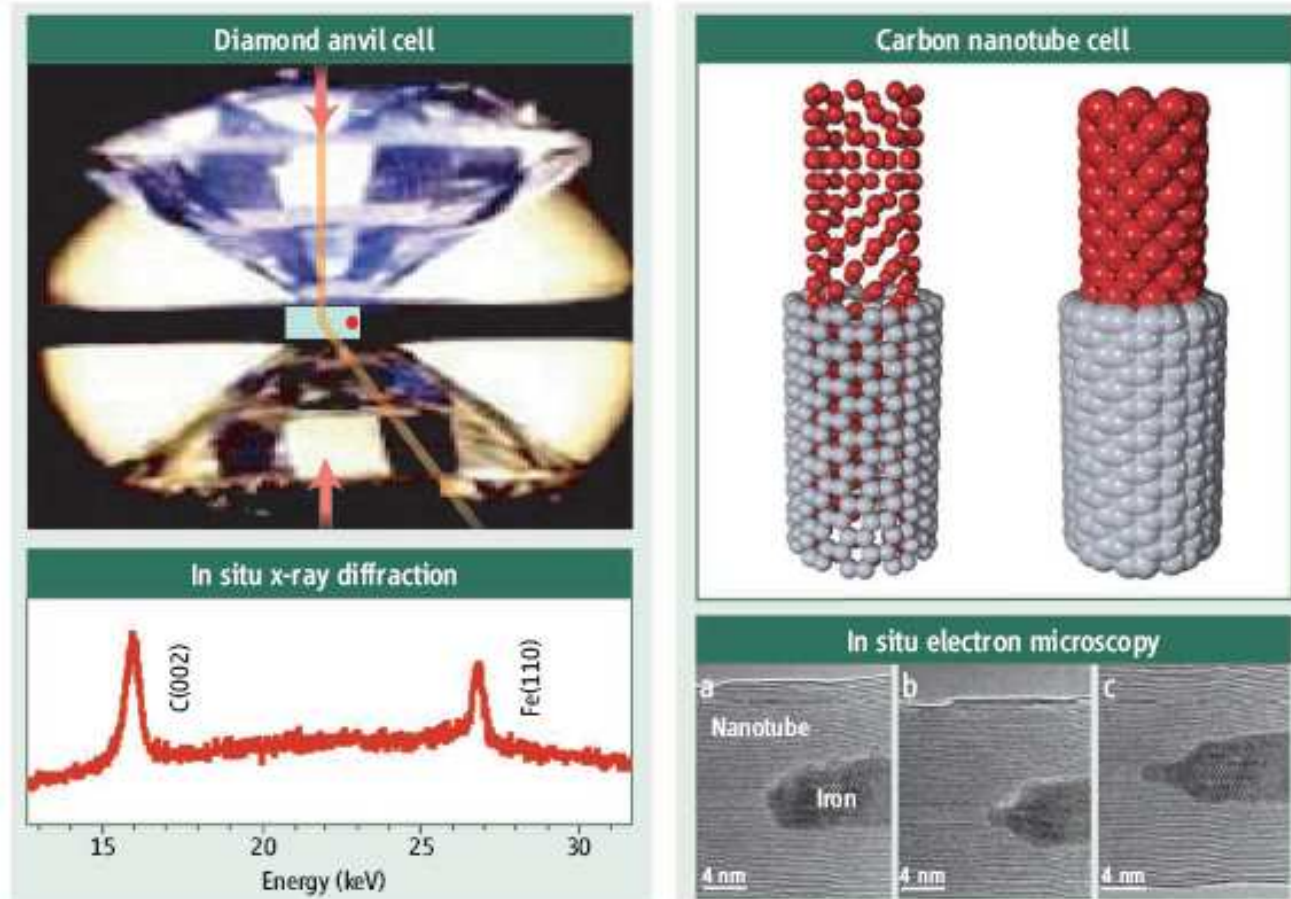

A matter of scale. (Left) A transparent diamond anvil cell allows in situ spectroscopic measurements of bulk samples. The red arrow represents an x-ray beam that is diffracted by the sample. (Right) A carbon nanotube self-compression cell enables in situ atomic-resolution snapshots at zero (a), intermediate (b), and high (~40 GPa) (c) pressure.

Wang & Zhao, *Science*, **312** (2006) 1149; Sun et al., *Science*, **312** (2006) 1199.



Bio and polymer science: more flux through thin sheet probes



- **Examples:** folding/unfolding of proteins & RNA; assembly of fibers; polymer collapse upon solvent changes; conformational changes upon ligand binding; monomer/multimer association.
- **Microfabricated laminar flow cells access microsecond equilibration mixing times.**
- **Data acquisition entirely limited by source brilliance. The ERL will extend time scales from present milliseconds to microseconds.**

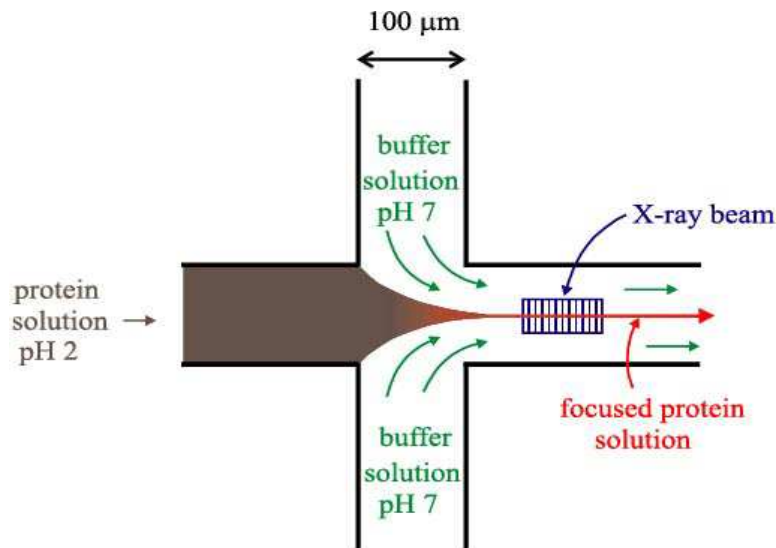

Thanks to Lois Pollack
Cornell Univ.



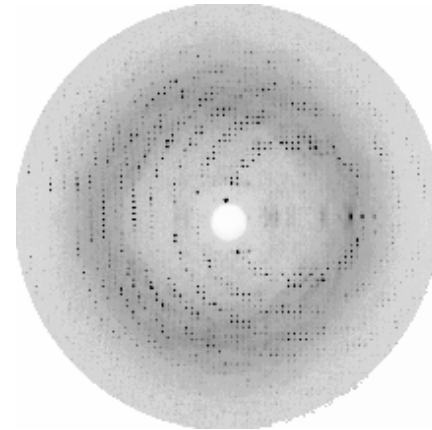
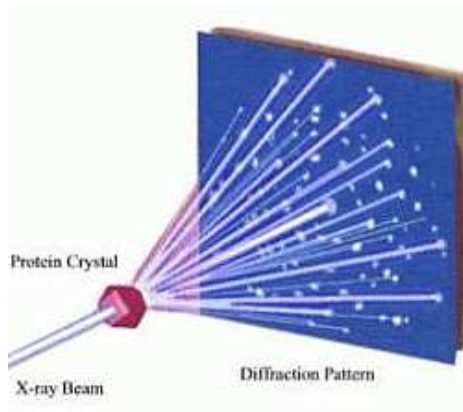

ERL enables new crystallographic method

1. Obtaining good crystals is rate limiting. Easier to obtain microcrystals. Radiation limits crystals to $> \sim (20\mu\text{m})^3$.
2. Single image sufficient to determine orientation matrix.
3. Plate microcrystals in random orientations onto ultrathin film support.
4. Scan film w/microbeam, recording diffraction images.
5. ERL microbeam intensity and low divergence allows this to be done with **micron-sized crystals.**

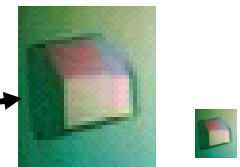
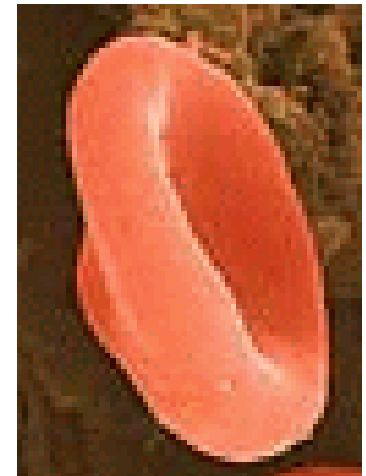

?

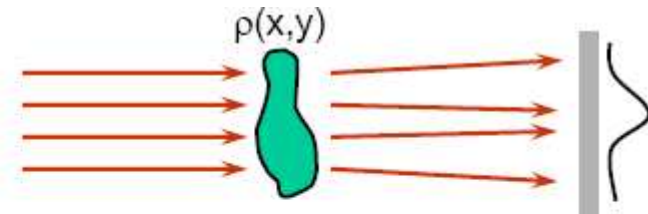
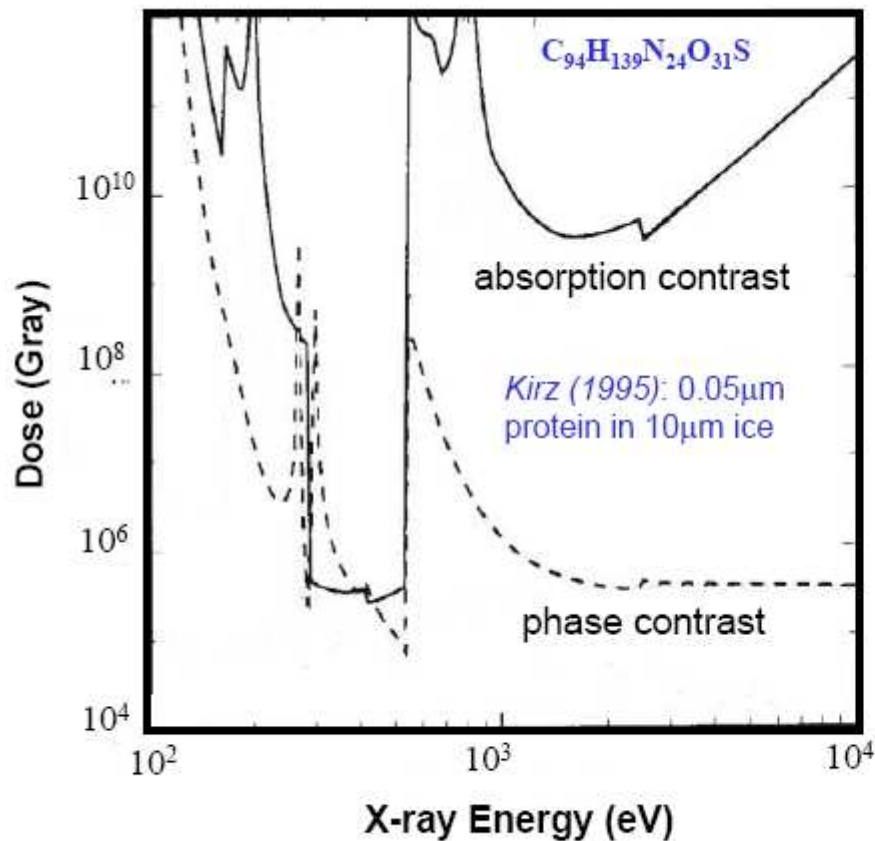

Refraction index: $n = 1 - \delta - i\beta$

- Phase contrast is $10^4 - 10^6$ higher than absorption contrast for protein in water at hard x-rays energies
- Required dose is reduced with phase contrast

In general, phase contrast requires more coherent x-ray beams



Tracheal Respiration in Insects Visualized with Synchrotron X-ray Imaging

Mark W. Westneat,^{*1} Oliver Betz,^{1,2} Richard W. Blob,^{1,3}
Kamel Fezzaa,⁴ W. James Cooper,^{1,5} Wah-Keat Lee⁴
Field museum of Chicago & APS, Argonne National Lab.

- Animal functions
- Biomechanics
- Internal movements
- New findings

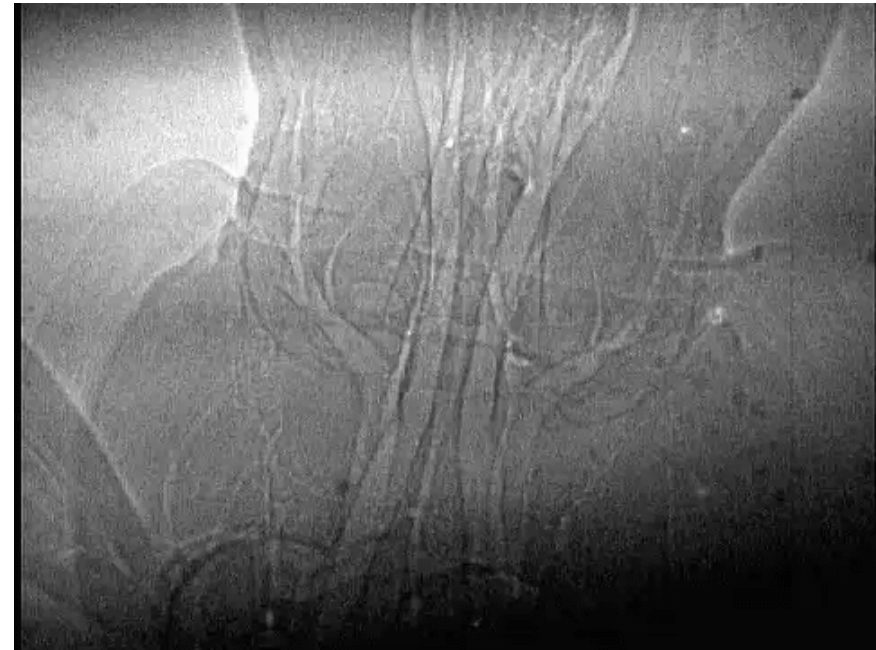

Science (2003) 299, 598-599.



Tracheal Respiration in Insects Visualized with Synchrotron X-ray Imaging

Mark W. Westneat,^{*1} Oliver Betz,^{1,2} Richard W. Blob,^{1,3}
Kamel Fezzaa,⁴ W. James Cooper,^{1,5} Wah-Keat Lee⁴
Field museum of Chicago & APS, Argonne National Lab.



Science (2003) 299, 598-599.

- Animal functions
- Biomechanics
- Internal movements
- New findings

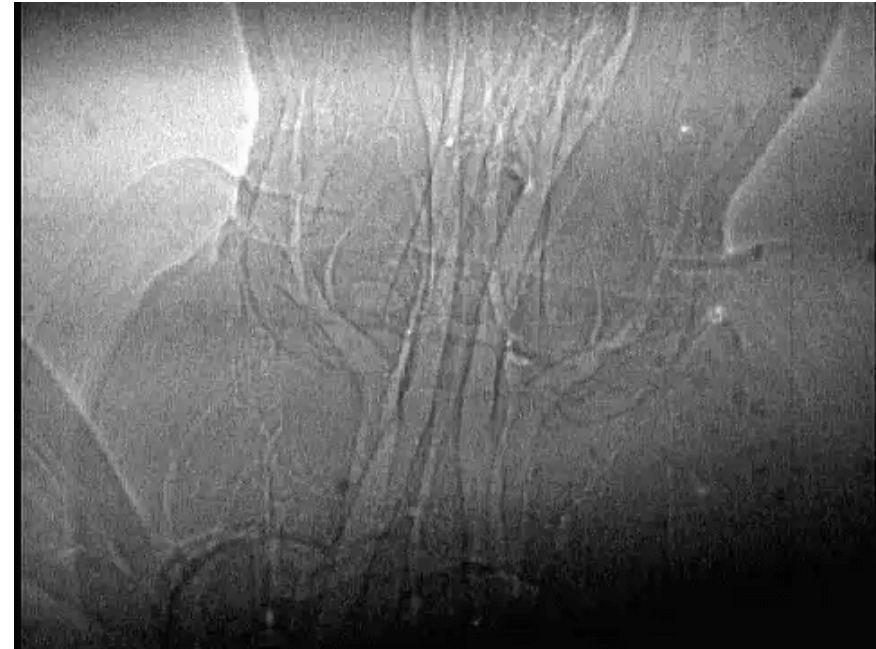

- ERL would extend these studies to much higher lateral resolution (sub μm) and faster time scales



Coherent imaging

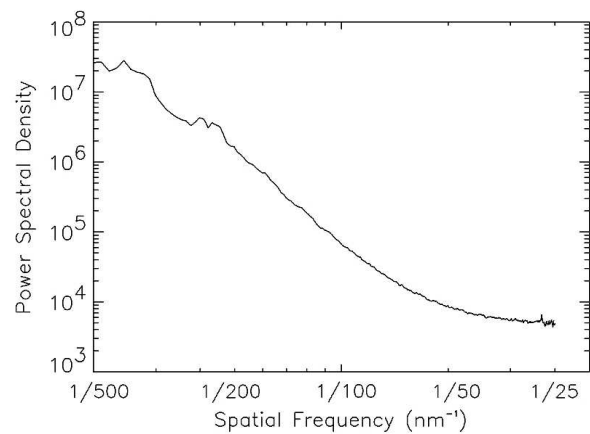
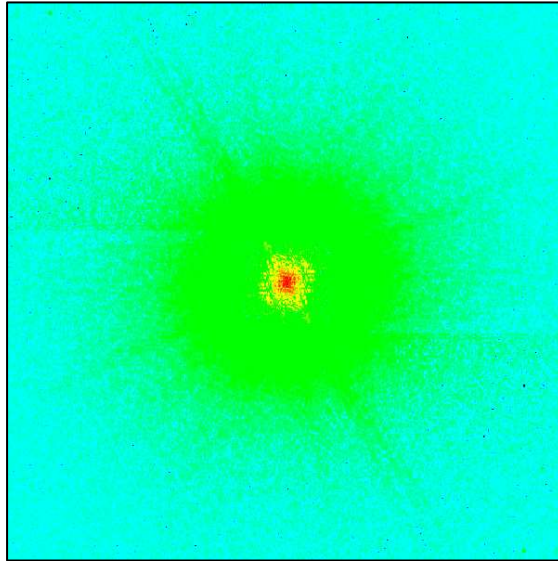

Miao et al., *Proc. Nat. Acad. Sci.* (2003)

E. Coli bacteria $\sim 0.5 \mu\text{m}$ by $2 \mu\text{m}$

Labeled with manganese oxide

SPring-8, $\lambda = 2 \text{ \AA}$, pinhole $20 \mu\text{m}$

Total dose to specimen $\sim 8 \times 10^6$ Gray

Diffraction image to $\sim 30\text{nm}$ resolution

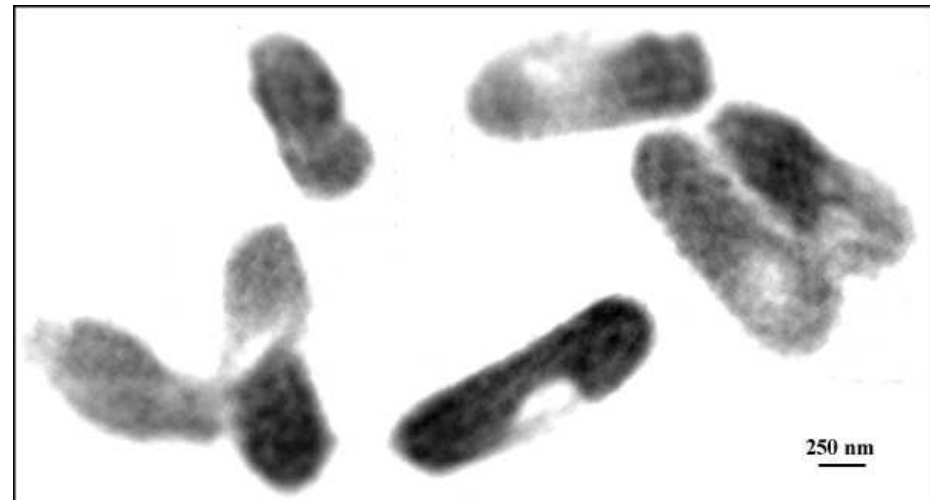



ERL workshops on areas of opportunity



- Do we understand the makeup of the Earth and planets?
- How does life behave at the bottom of the ocean?
- Can we meet the challenges of the energy crisis?
- Can we improve polycrystalline materials?
- How do macromolecules (proteins) behave in solution?
- Can we find the structure of life?
- Do we understand the glass transition?
- Can we see structural changes on the ps timescale?



The injector: round beam optimization

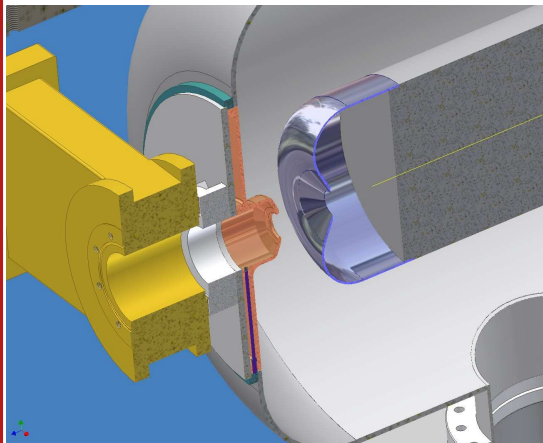
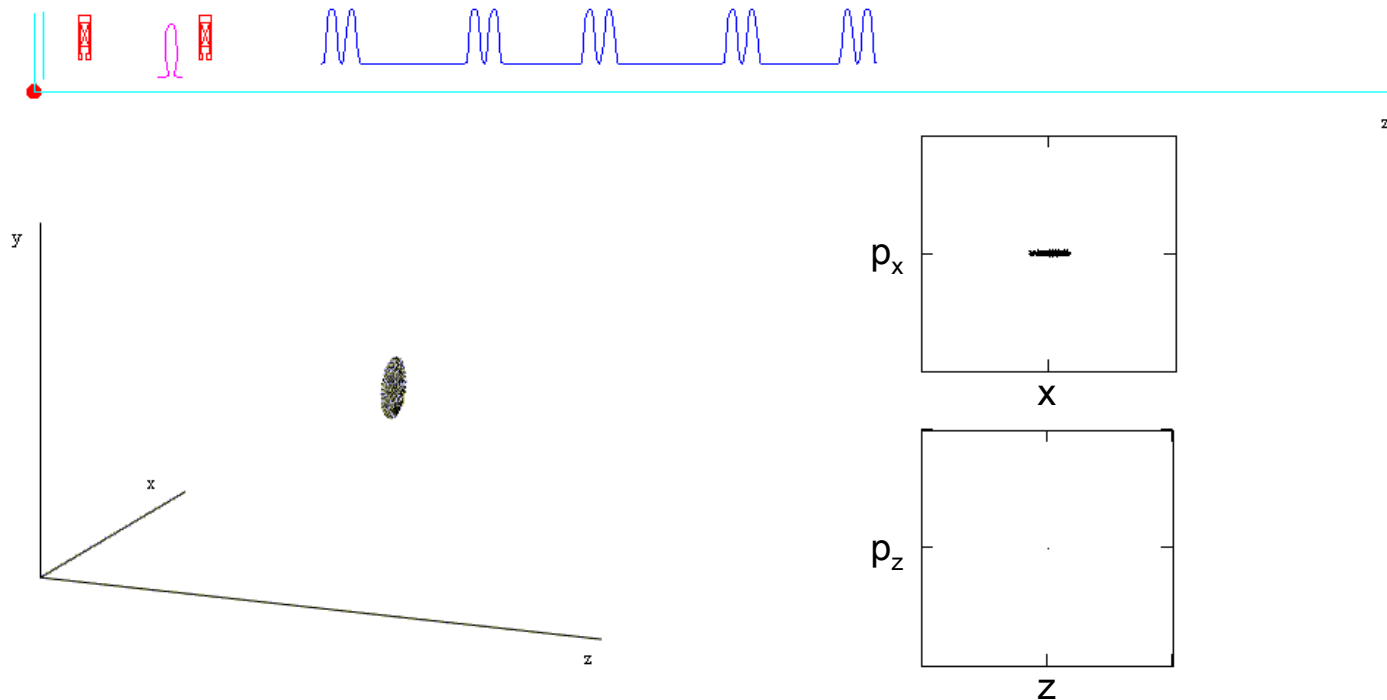

DC source for high current & low emittances

- Simulations show 10 times smaller emittances than previously thought possible, and 50 times smaller than standard.
- Gun development, coating for low field emission
- Photocathode development, neg. el. affinity GaAs, cooled
- Laser beam shaping



The injector optimization



HIGH BRIGHTNESS, HIGH CURRENT INJECTOR DESIGN FOR THE CORNELL ERL PROTOTYPE*

2003 Particle Accelerator Conference
 I.V. Bazarov† and C.K. Sinclair

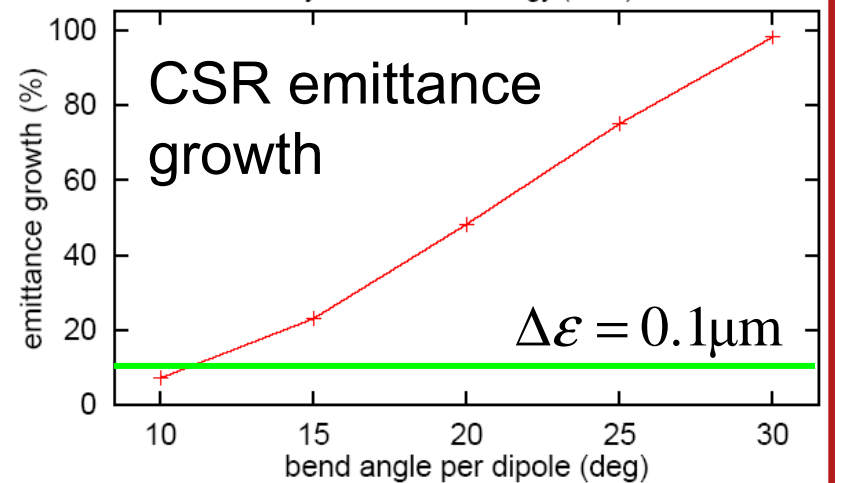
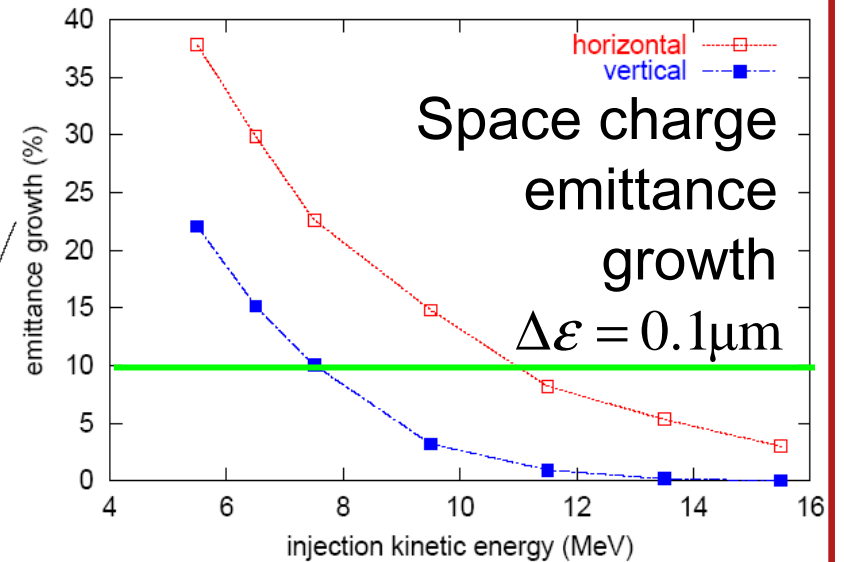
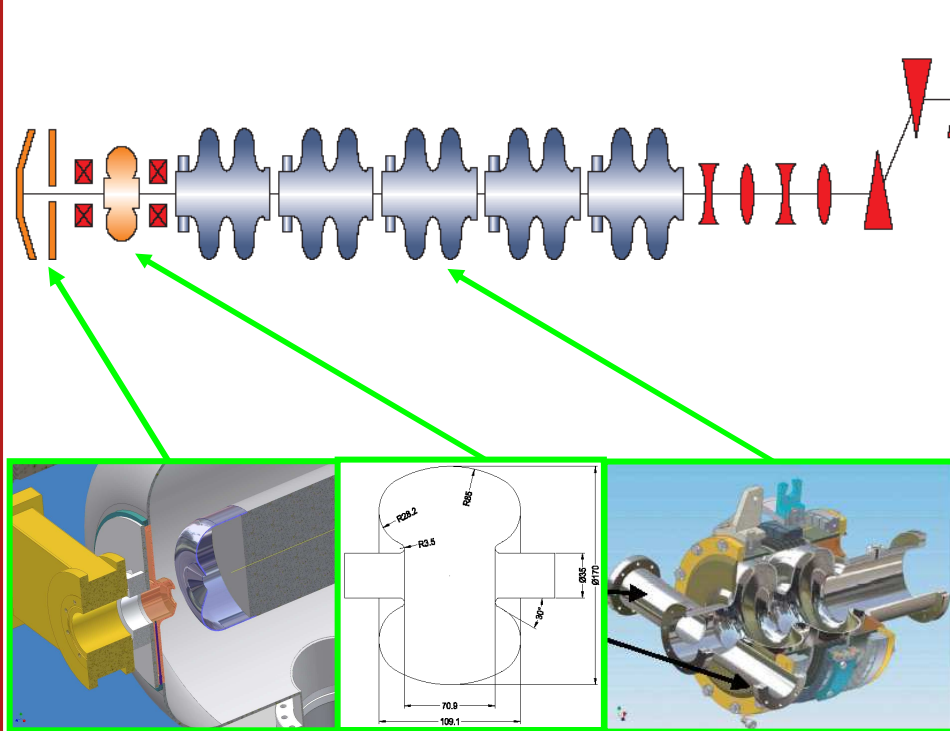



(1) Challenges for x-ray ERLs



- **Production of low emittances + limiting emittance growth**
 - **Optics in the linac for very different energies (0.01 - 5GeV)**
 - **Limit coupler kicks / cavity misalignments**
 - **Limit optics errors and adjust fields to radiated energy**
 - **Low emittance growth optics similar to light sources**



Cornell Injector prototype: Verification of beam production

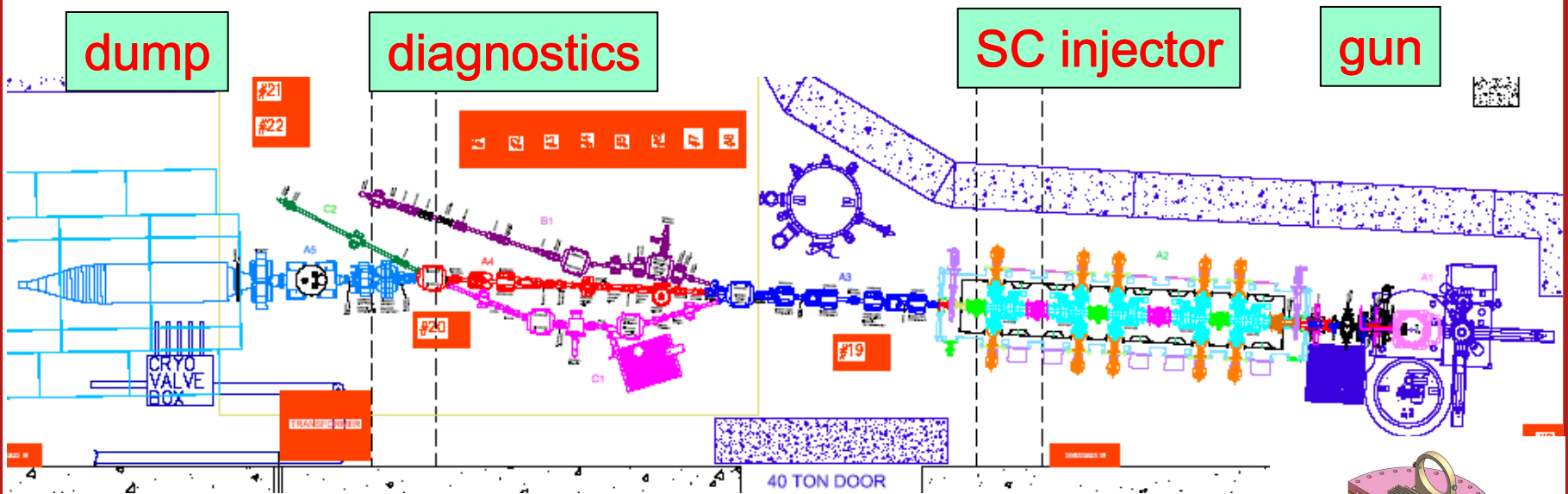

Power sup.



Cathode



Photo emitter

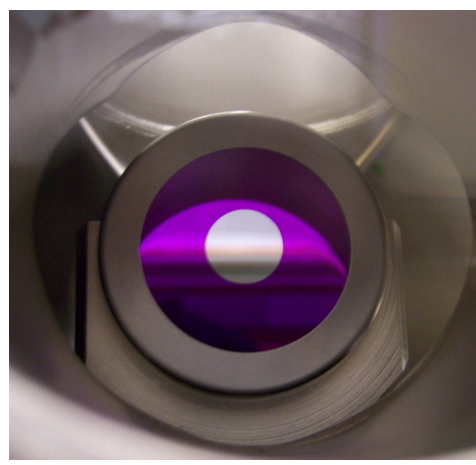

gun

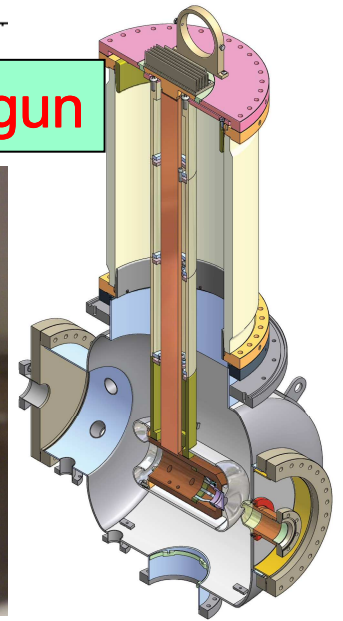



Gun prototype: well advanced



CLASSE

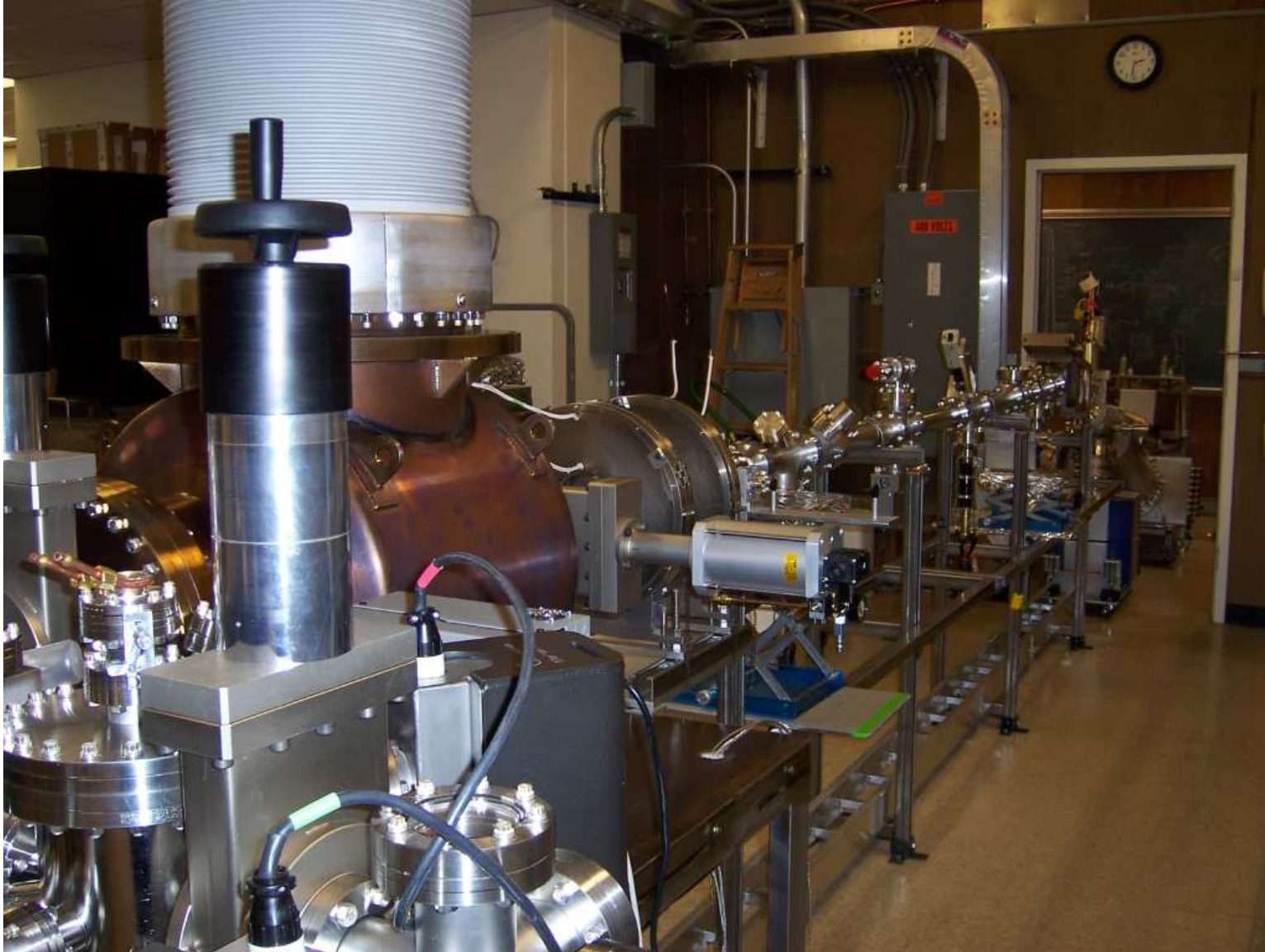



ERL accelerator R&D and construction



CLASSE

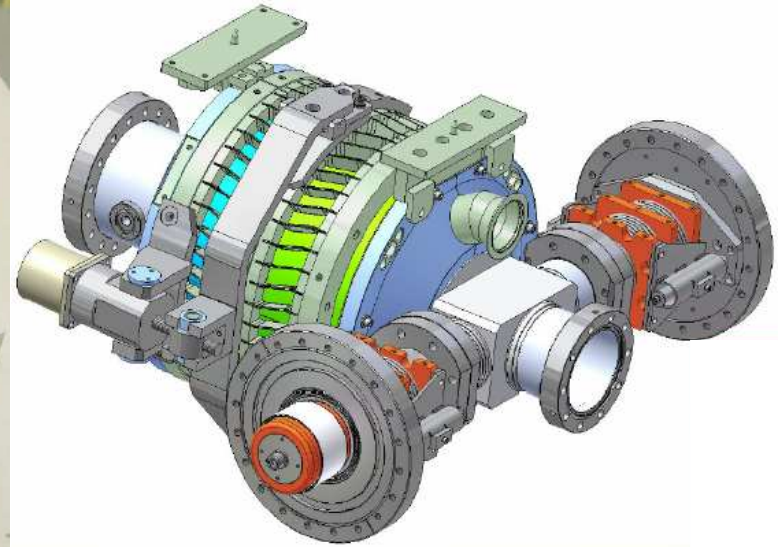

Superconducting Cavities, high power input coupler, and high precision frequency tuners are all developed and build at Cornell (with outside collaborators)



First vertical test

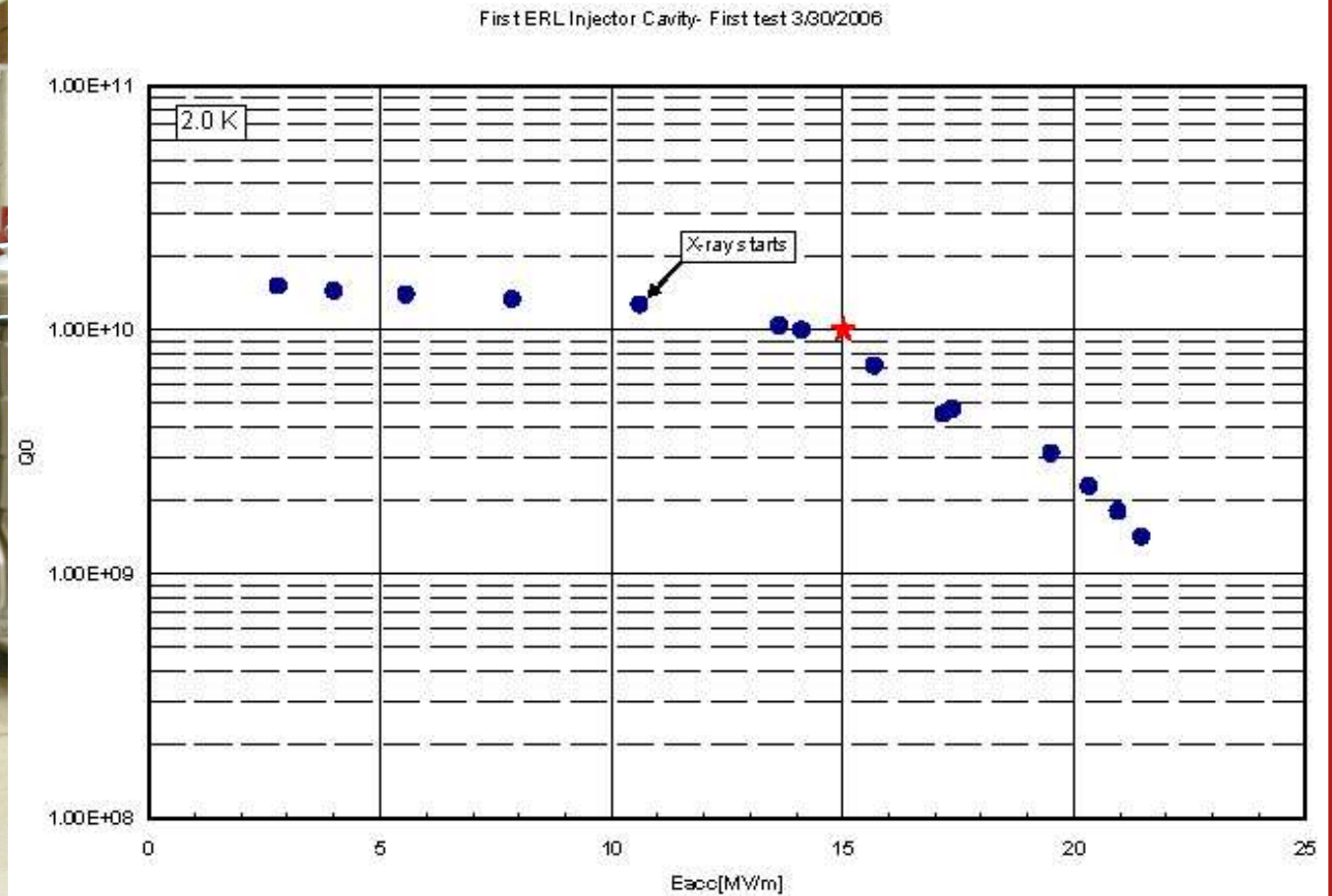



Assembly of the injector accelerator



CLASSE

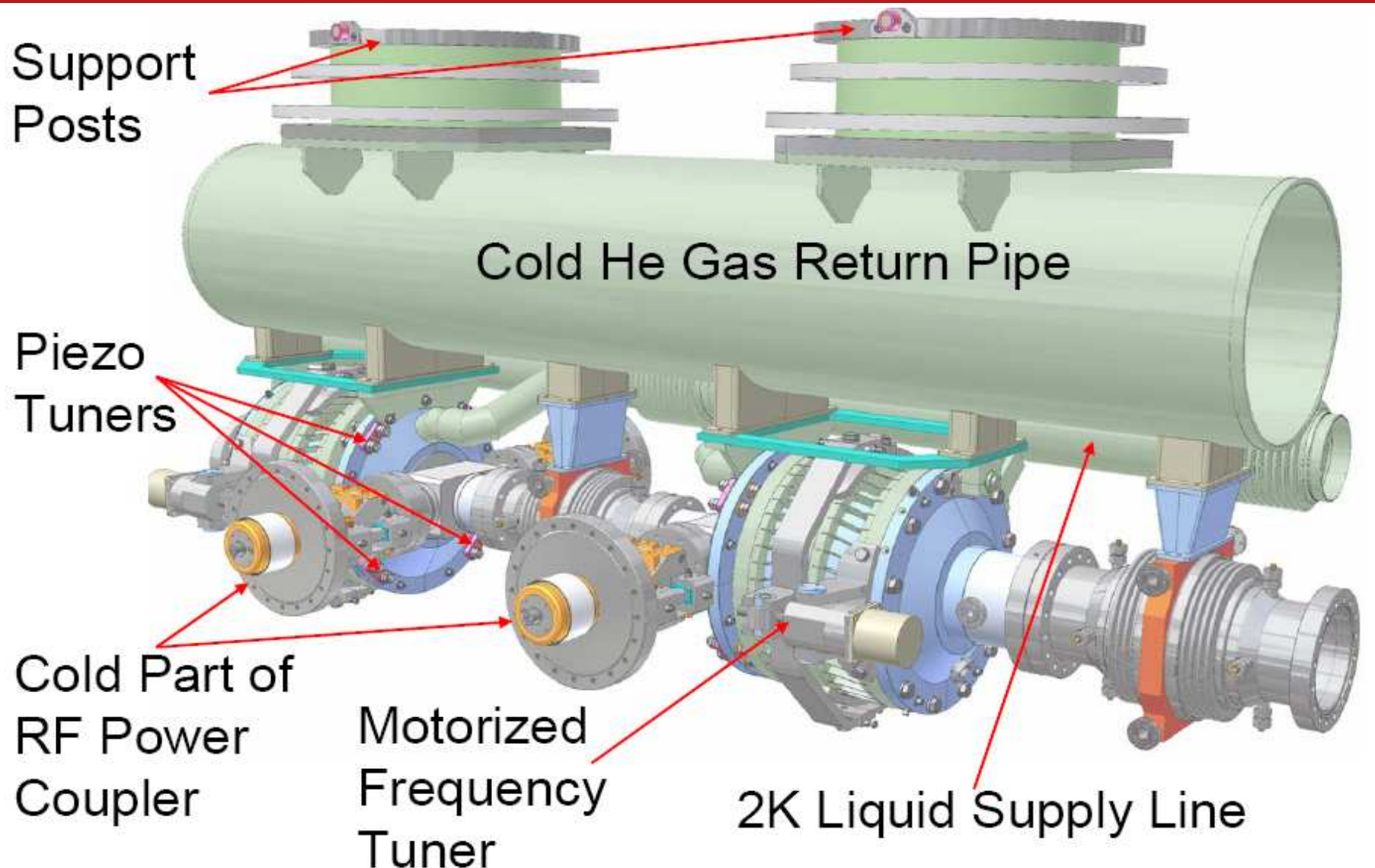



Assembly of the injector accelerator

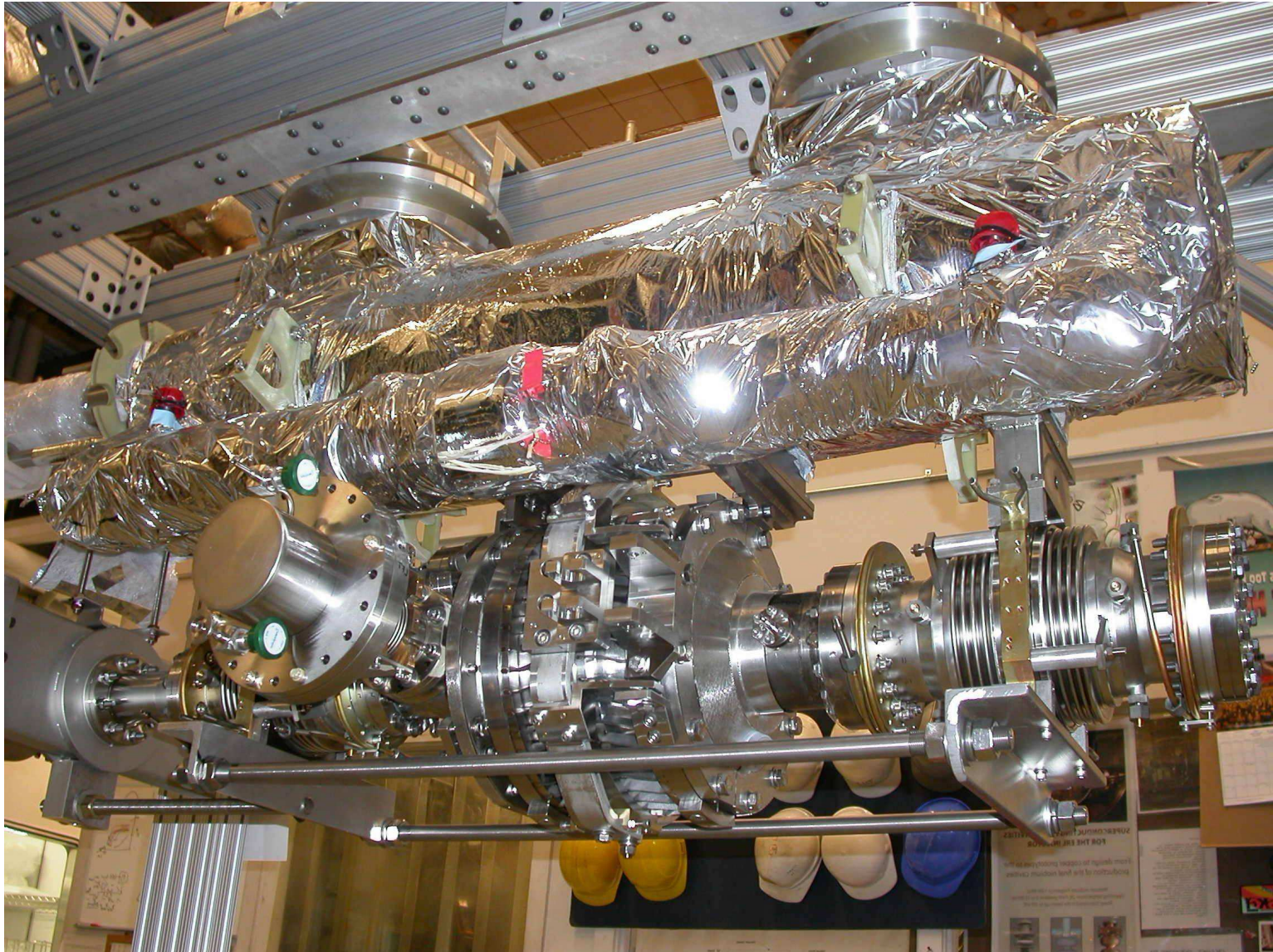



List of desired x-ray beamlines



CLASSE

5 GeV ERL: table of beamlines

last changes: Sept. 04, 2006 by GH

#	Function	Application	ID	L(m)	β (m)	Mode	beam	E range	BL length
1	Inelastic Scattering	meV resolution	U	25	12	"		$20 < E_s(\text{KeV}) < 30$	70m
2	Diagnostic beamline	machine diagnostics	U	2.5	2.5	all modes	pink, mono	"	70m
3	Protein crystallography III	micro-focus	U	2.5	1.25	"	"	"	70m
4	Nanoprobe	1 nanometer beams	U*	2.5	0.5	Hi-Coh		$1 < E^*(\text{KeV}) < 10$	70m
5	microscope, nanoprobe	TXM, STXM	U	2.5	0.5	"	"	"	70m
6	phase contrast, topography	biomed, matscience	U	2.5	0.5	Hi Coh	mono	$< 25\text{KeV}$	200m
7	coherent diffraction, XPCS	microscopy, dynamics	U	25	25	5.0	pink, mono	$< 25\text{KeV}$	80m
8	Protein crystallography II	MAD	U	5.0	1.0	"	"	"	70m
9	SoftX microscope	biomaterials	helU	5.0	2.5	Hi Flux	mono	$< 5\text{KeV}$	70m
10	SoftX, XMCD, ARPES	mag/elect materials	helU	5.0	2.5	"	vari-polariz	$< 5\text{KeV}$	70m
11	High Energy Scattering	PDF, Compton, etc	U	5.0	2.5	"	high K & n	$> 100\text{KeV}$	80m
12	Protein crystallography I	high throughput	U	5.0	2.5	Hi-flux	tuneable	$< 25\text{KeV}$	70m
13	Materials science I	high pressure	U	5.0	2.5	Hi-flux		$20 < E(\text{KeV}) < 40$	70m
14	Materials science II	general application	U	5.0	2.5	"		$5 < E(\text{KeV}) < 30$	70m
15	Materials science III	resonant el&inelastic	U	5.0	2.5	"	$\Delta E(\text{eV}) < 1$	$< 25\text{KeV}$	70m
16	GSAXS, XPCS, SAXS	polymers, liquids	U	5.0	2.5	"	pink & 1%bw	"	70m
17	ASAXS, micro-SAXS	catalys	U	5.0	2.5	"	"	"	70m
18	Femtosecond science	pump-probe, etc	U	25	5	Ultra-fast	timing	$< 25\text{KeV}$	70m



5GeV ERL extension to CESR

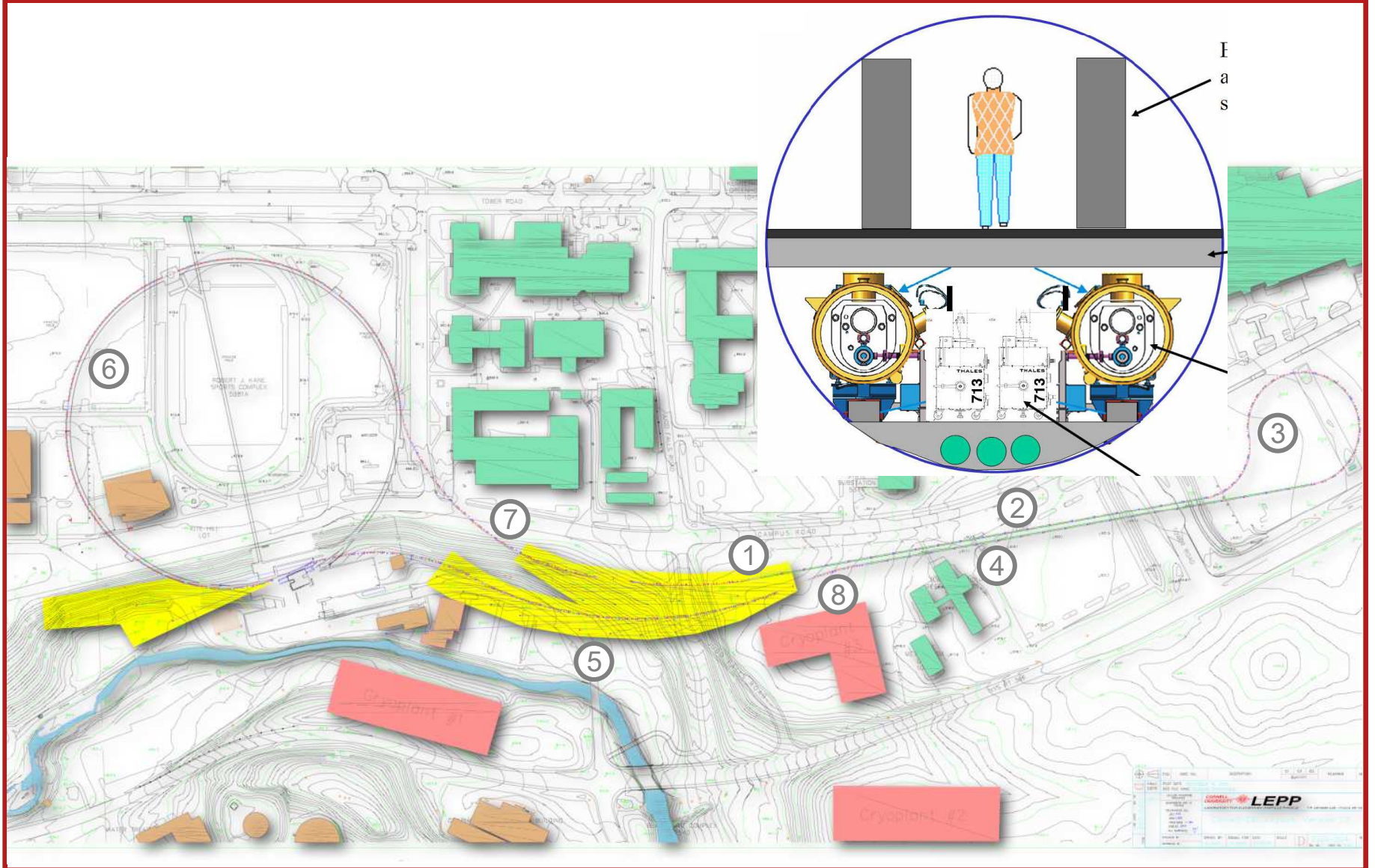



One pass, high charge mode (D)



A separate injector linac injects into the second 2.5GeV linac at 100kHz with up to 1nC per bunch.

Two-stage bunch compression with 3rd-harmonic linearizer cavity at low energy produces bunches as short as 50fs.

The 125kW beam is not energy recovered, but dumped.

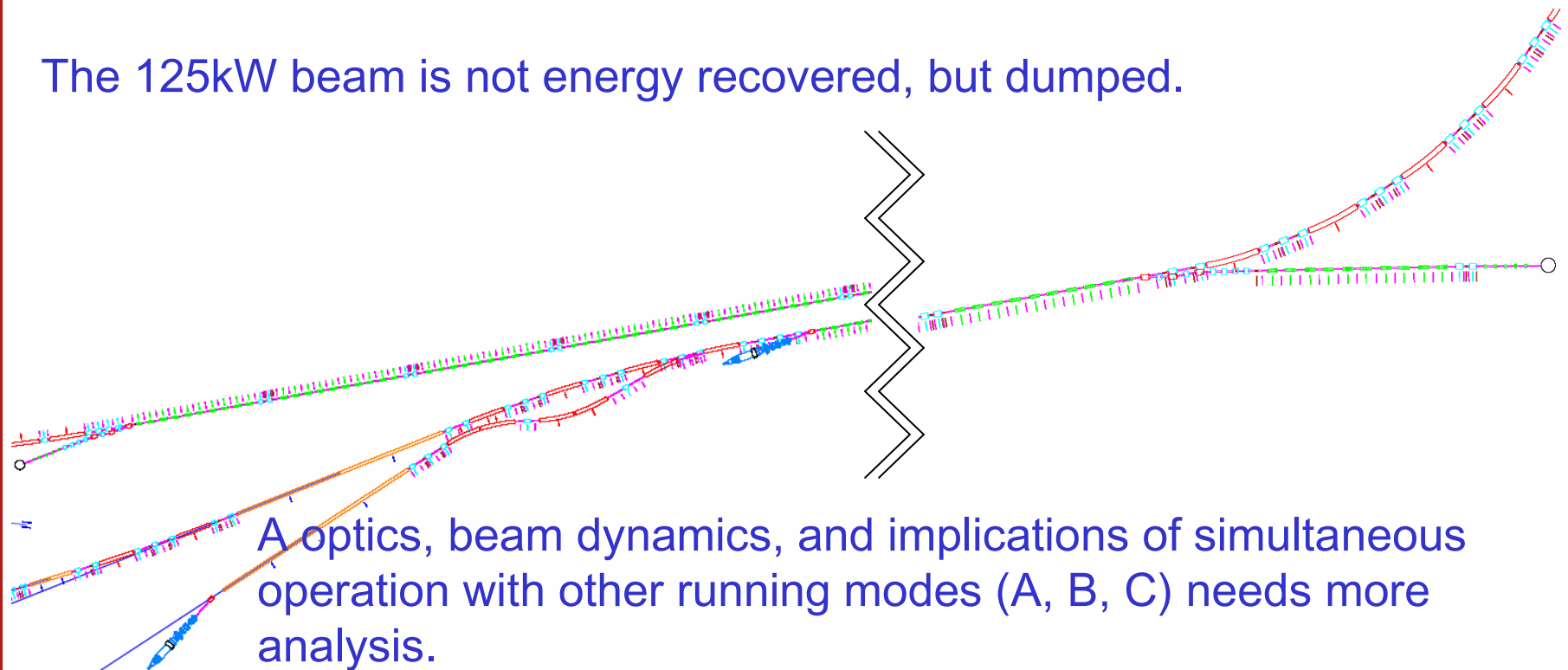

A optics, beam dynamics, and implications of simultaneous operation with other running modes (A, B, C) needs more analysis.



Incoherent Synchrotron Radiation (ISR)

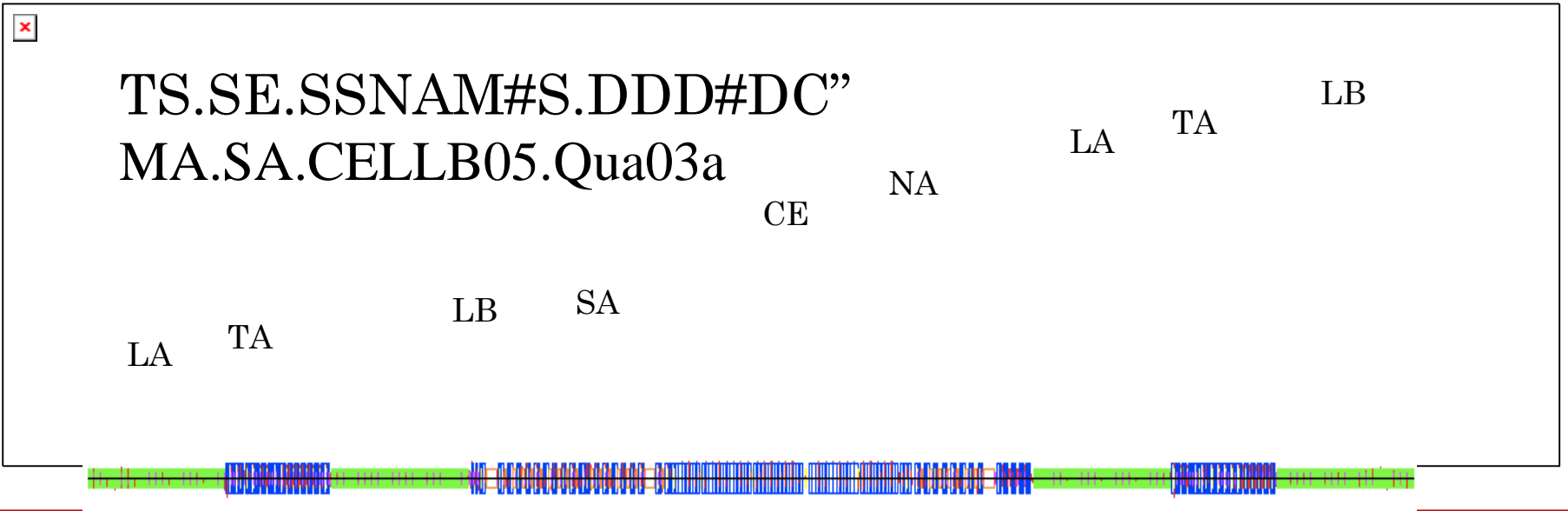
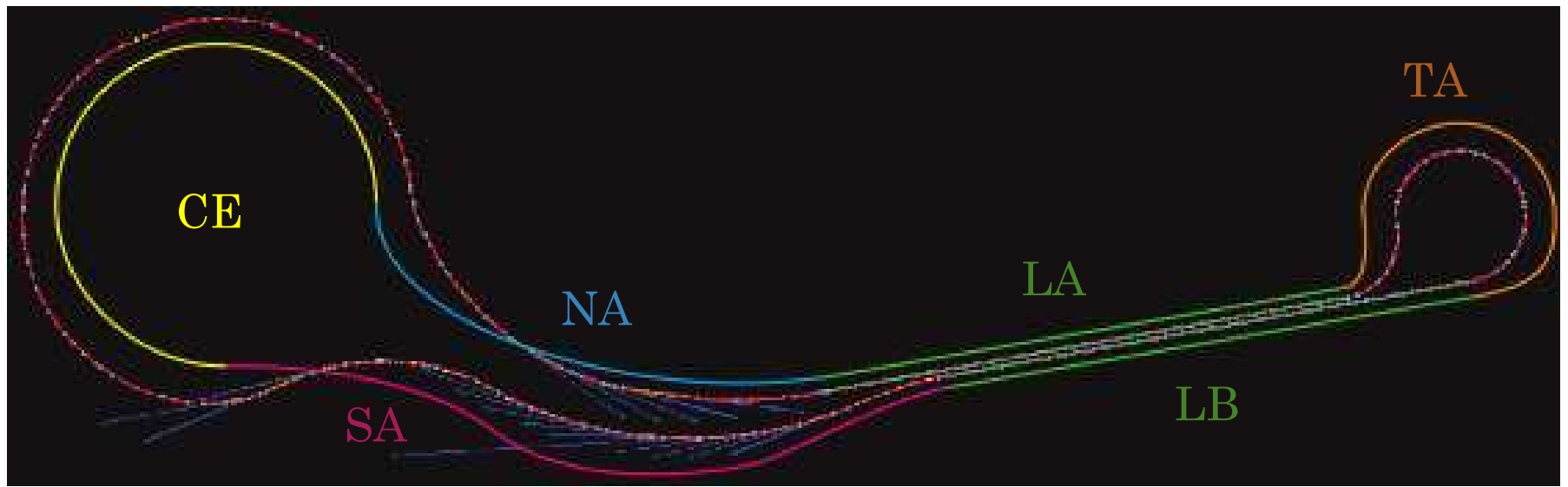



(2) Challenges for x-ray ERLs



- **Limit energy spread after deceleration by a factor of 500**
 - **Accurate time of flight correction, including sextupoles**
 - **Limit energy spread from wake fields**
 - **Limit energy spread from intra beam scattering (IBS) and rest gas scattering**
 - **Limit energy spread from incoherent / coherent synchrotron radiation (ISR / CSR)**



CSR in ERL bends



CLASSE

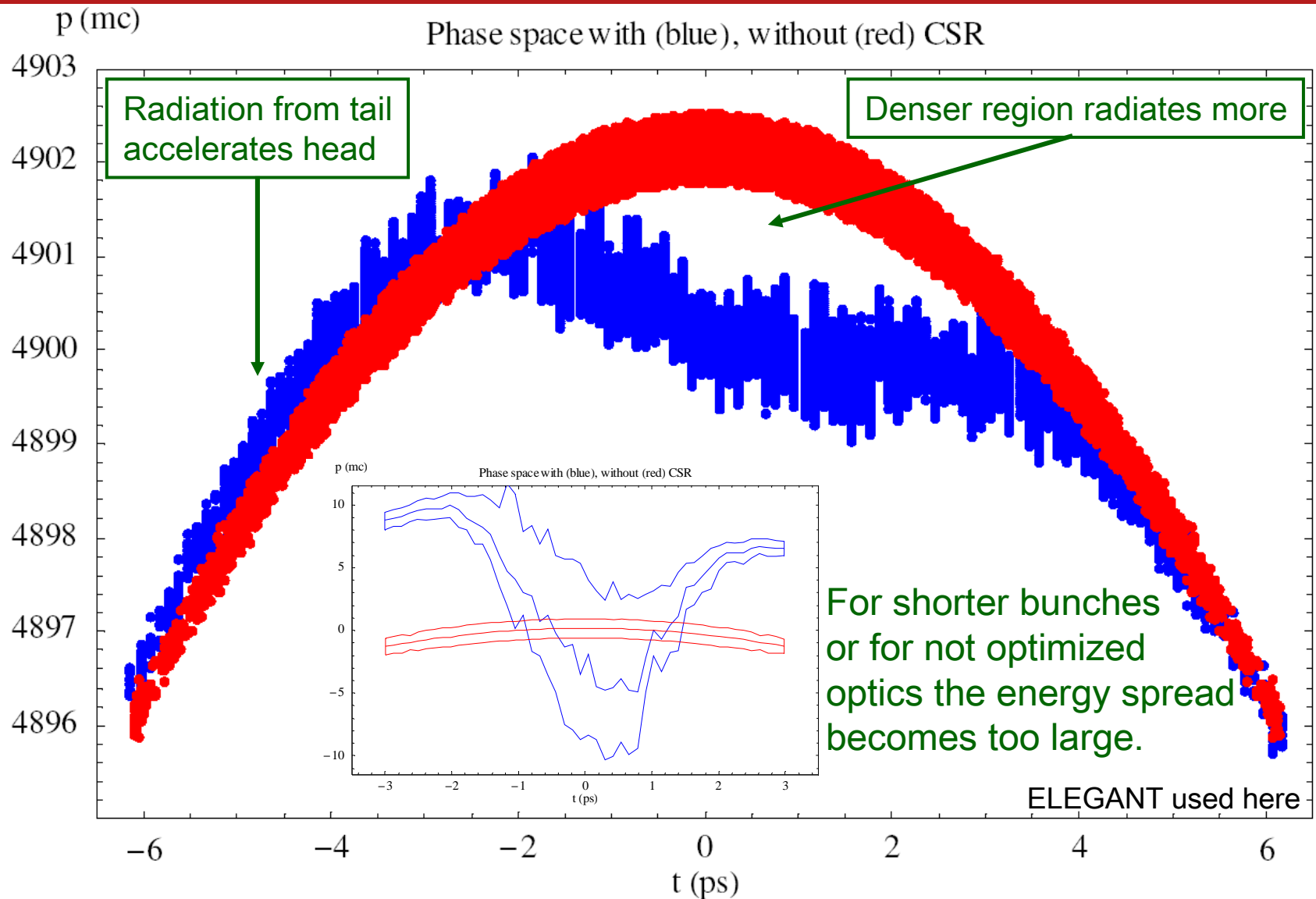



(3) Challenges for x-ray ERLs



- **Beam loss concerns**
 - **Beam loss from IBS / Touschek**
 - **Rest gas scattering**
 - **Disturbance from ions / ion removal**
 - **Halo development**



Scattering and background: IBS

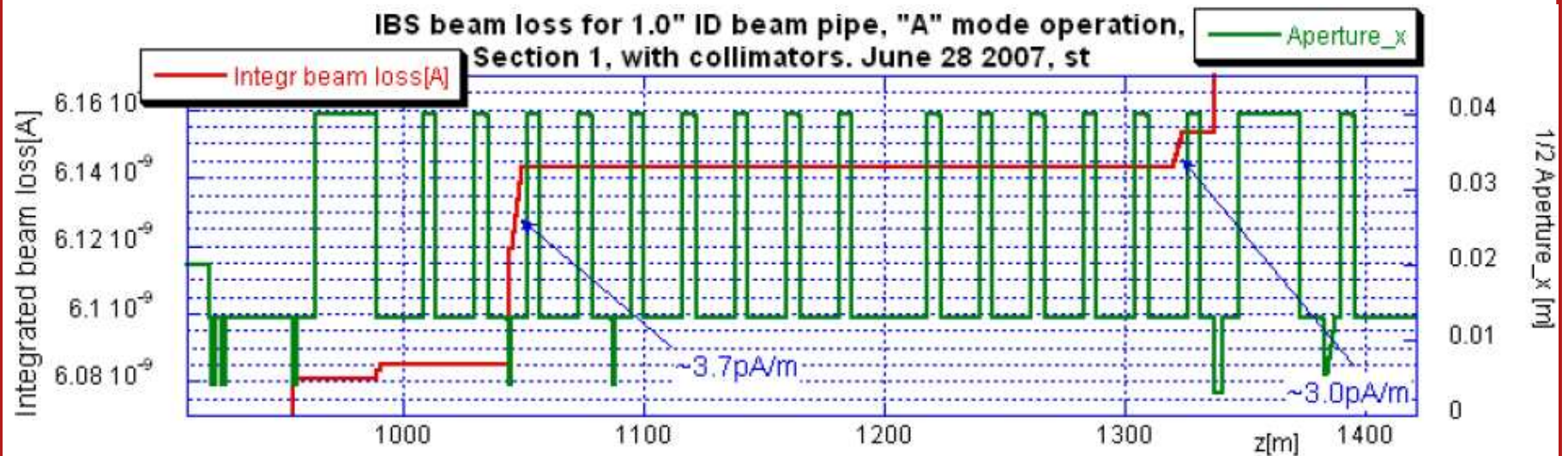
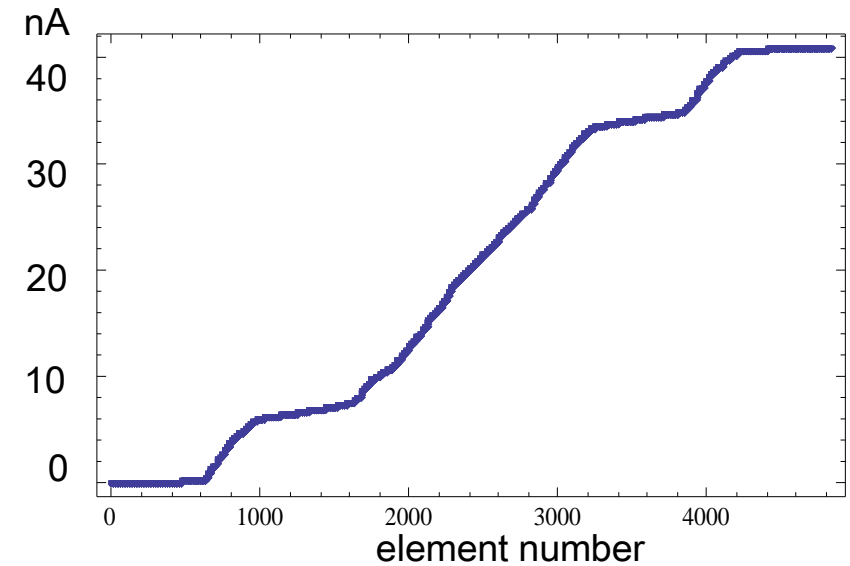
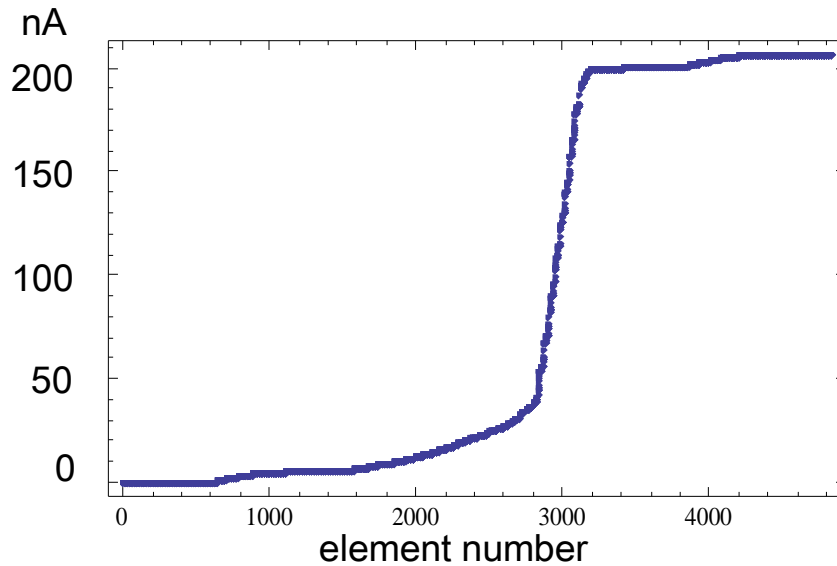



Shielding and x-ray optics



CLASSE

1st optics at 35m after center of undulator, outside shielding wall.
80m long x-ray beamlines.

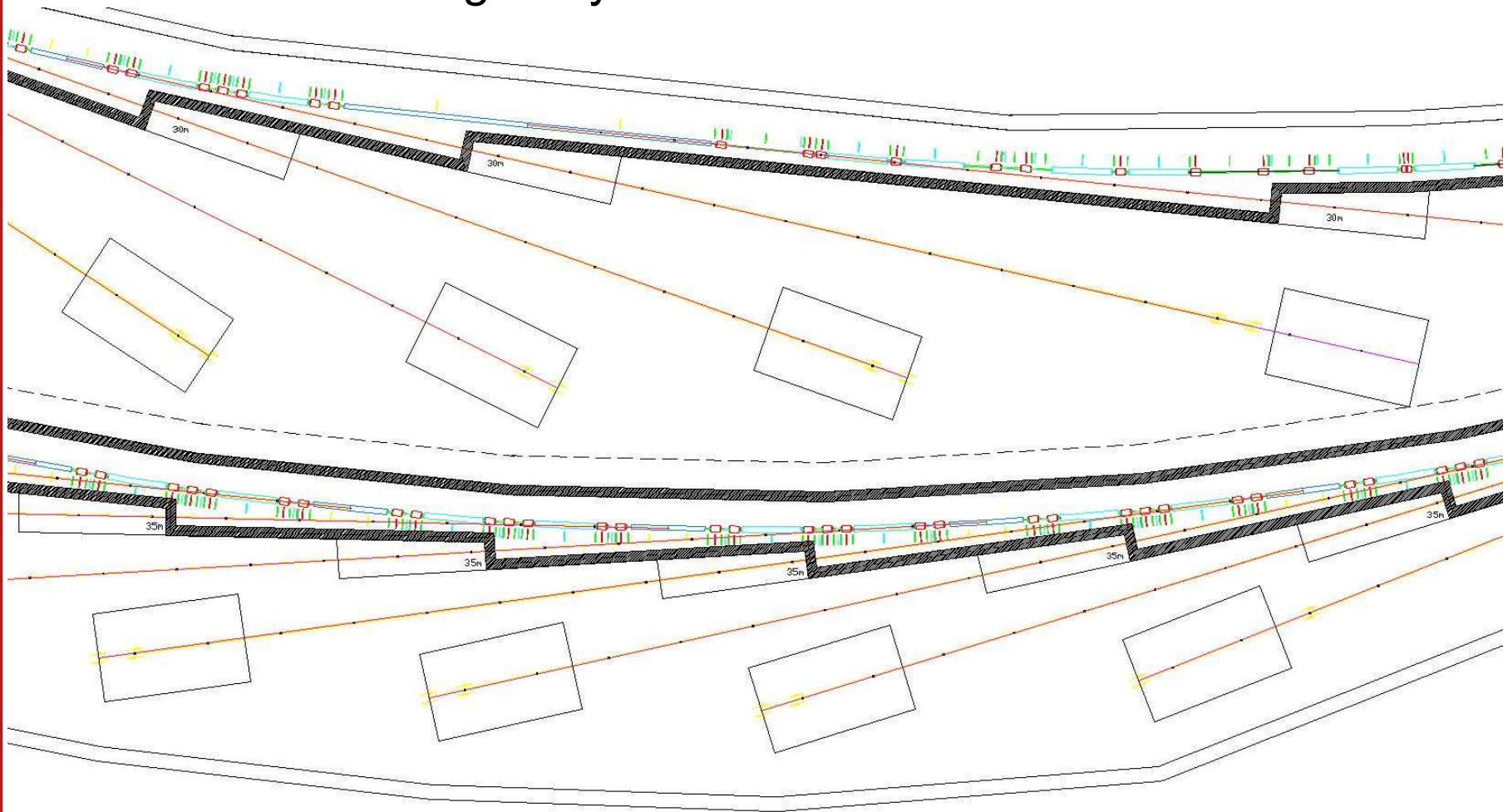



Ion focusing



- Ion are quickly produced due to high beam density

Ion	$\sigma_{col}, 10\text{MeV}$	$\sigma_{col}, 5\text{GeV}$	$\tau_{col}, 5\text{GeV}$
H_2	$2.0 \cdot 10^{-23} \text{m}^2$	$3.1 \cdot 10^{-23} \text{m}^2$	5.6s
CO	$1.0 \cdot 10^{-22} \text{m}^2$	$1.9 \cdot 10^{-22} \text{m}^2$	92.7s
CH_4	$1.2 \cdot 10^{-22} \text{m}^2$	$2.0 \cdot 10^{-22} \text{m}^2$	85.2s

- Ion accumulate in the beam potential. Since the beam is very narrow, ions produce an extremely steep potential – they have to be eliminated.
- Conventional ion clearing techniques:
 - 1) Long clearing gaps have transient RF effects in the ERL [**2ms every 7ms**].
 - 2) Short gaps have transient effects in injector and gun and produce more beam harmonics that excite HOMs [**0.4 ms every 7ms**].
 - 3) DC fields of about 150kV/m have to be applied to appropriate places of the along the accelerator, without disturbing the electron beam.
But remnant ion density before clearing can still cause emittance growth.



Ions in an ERL beam



CLASSE

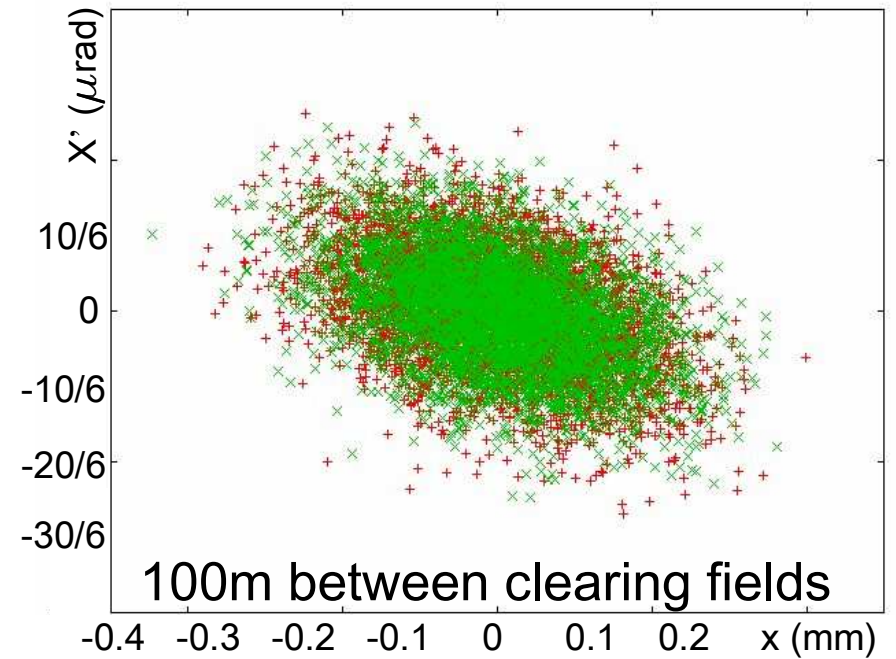
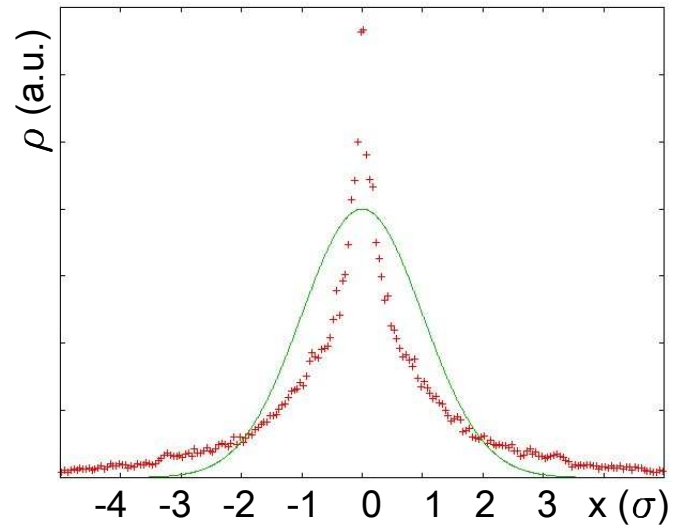



Ions in an ERL beam



CLASSE

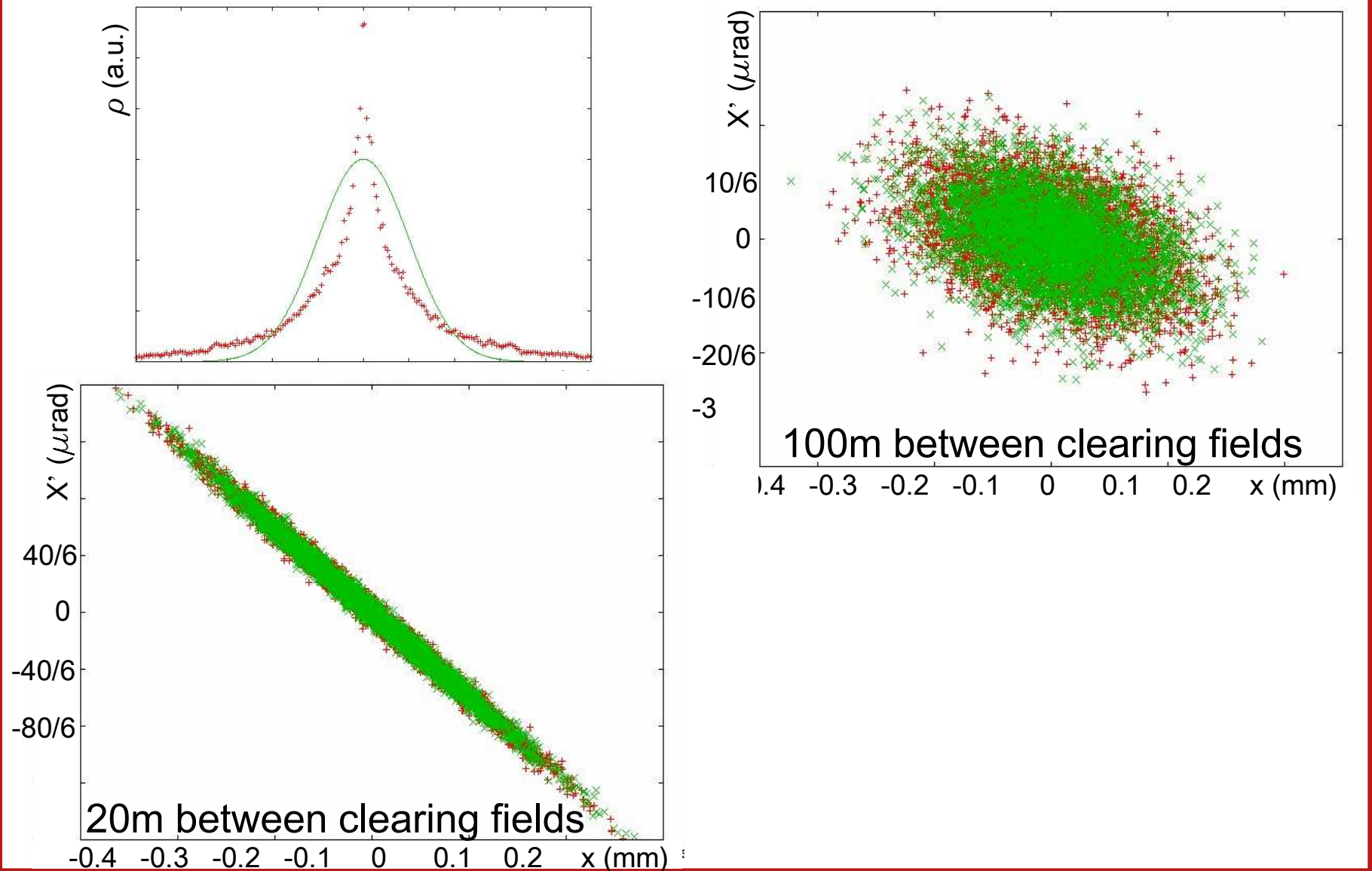



Ions in an ERL beam



CLASSE

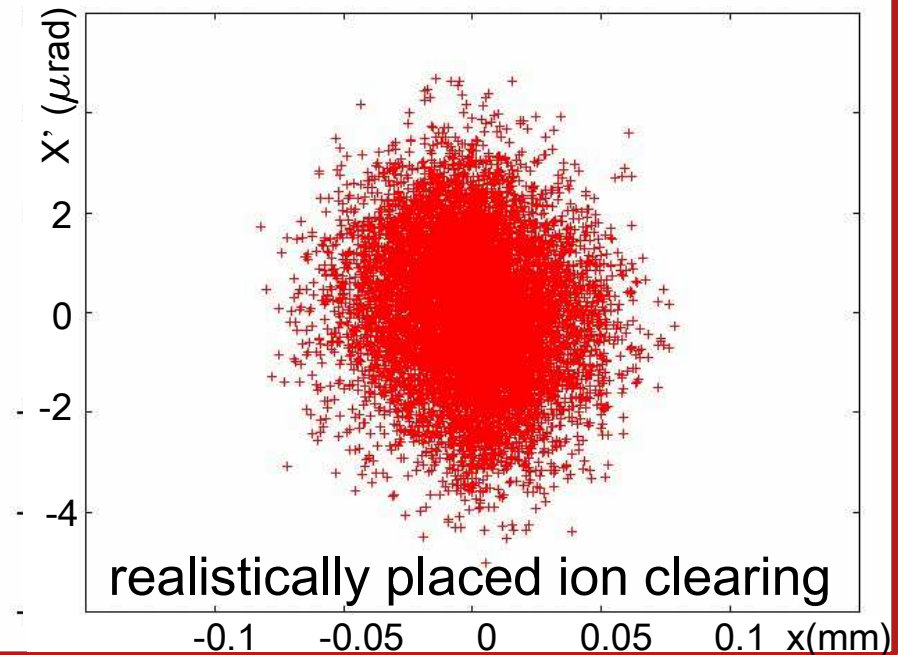
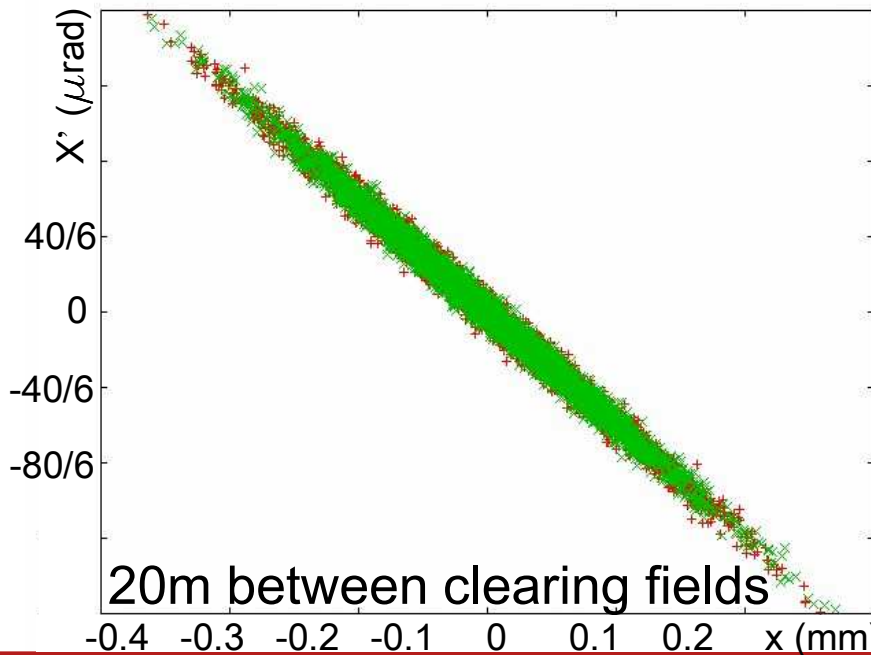
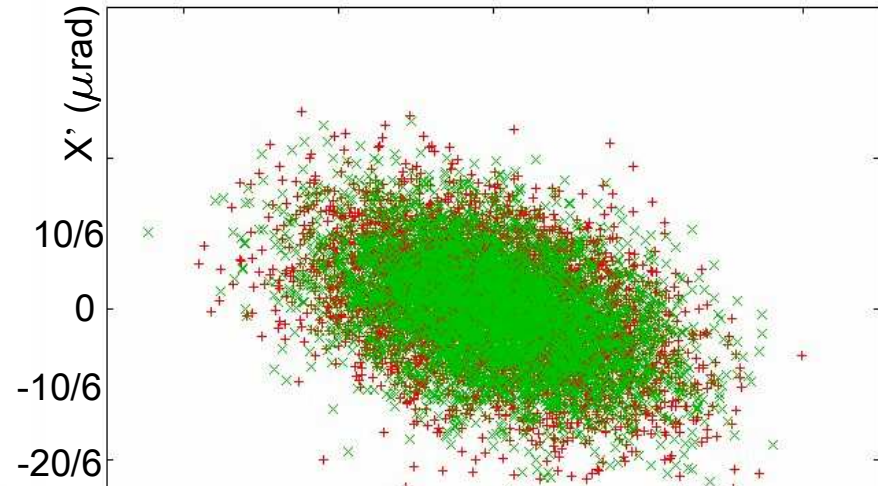
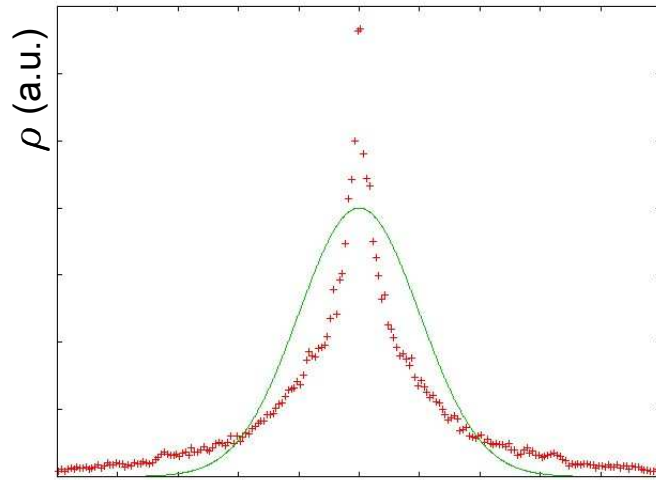



(4) Challenges for x-ray ERLs



- **Superconducting RF challenges**
 - Phase and amplitude control for very narrow frequency window (10^{-8})
 - Avoid heating / Higher order mode absorption
 - Limit cooling power



Cavity control for SC linacs (ERL & ILC)



CLASSE

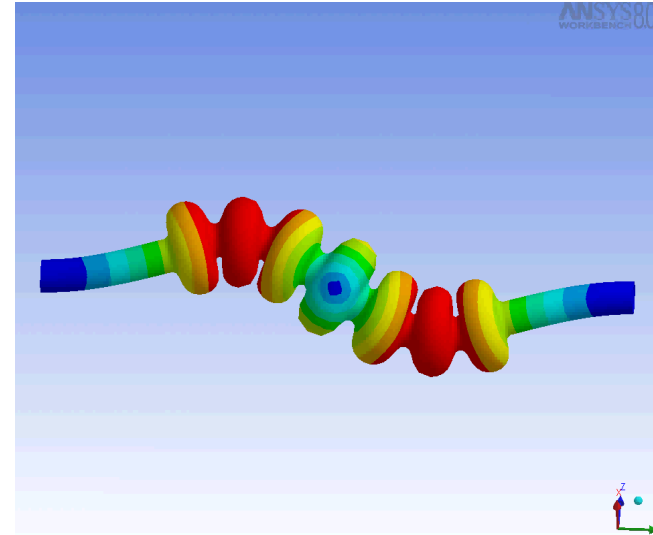
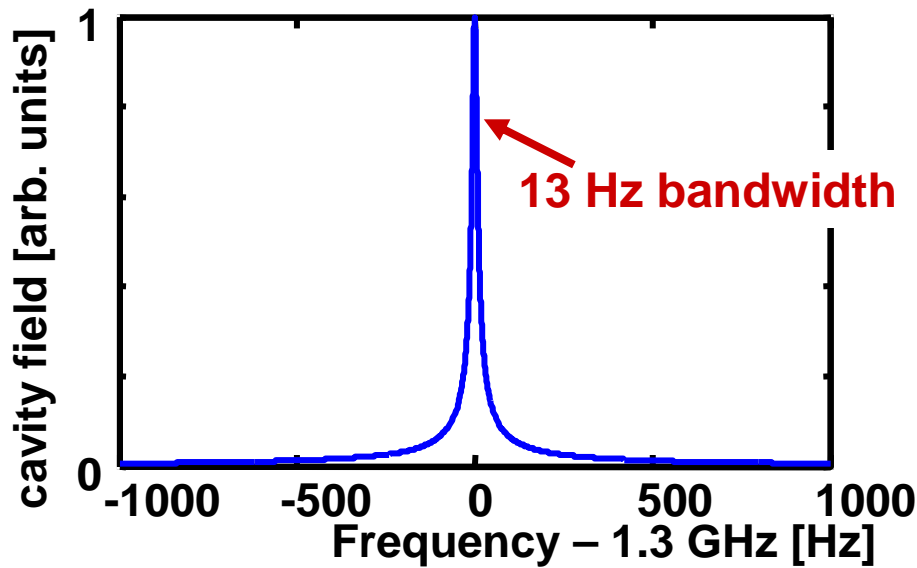

- Run cavity with lowest possible bandwidth for ERL.
- But frequency stabilization becomes very critical.

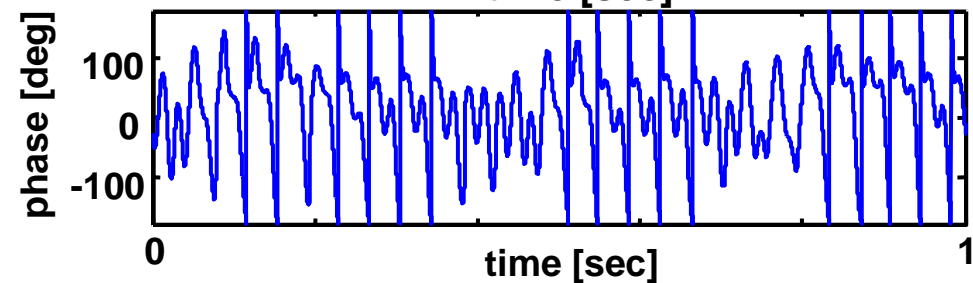
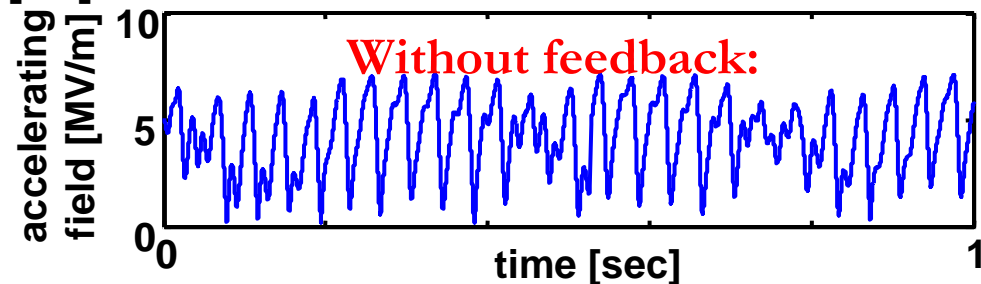



Cavity control for SC linacs (ERL & ILC)



CLASSE

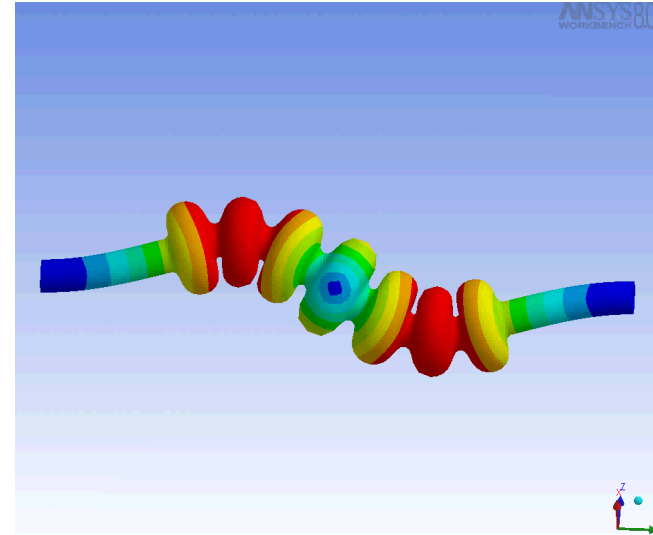
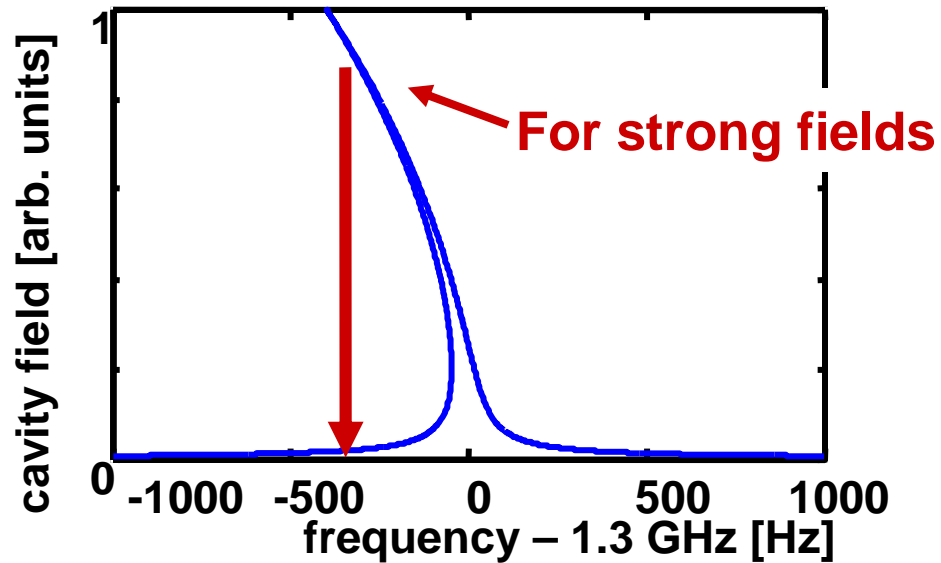

- Run cavity with lowest possible bandwidth for ERL.
- But frequency stabilization becomes very critical.

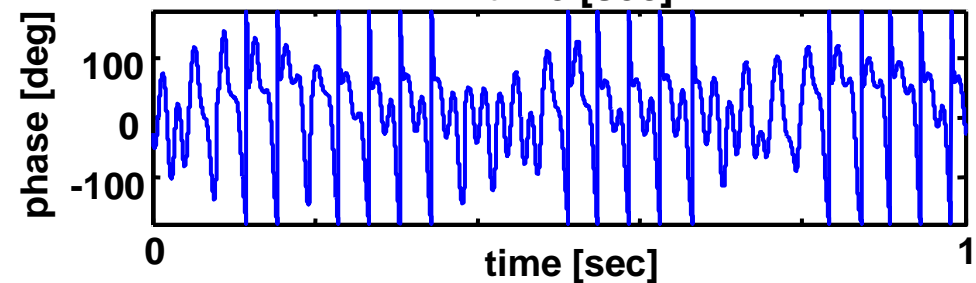
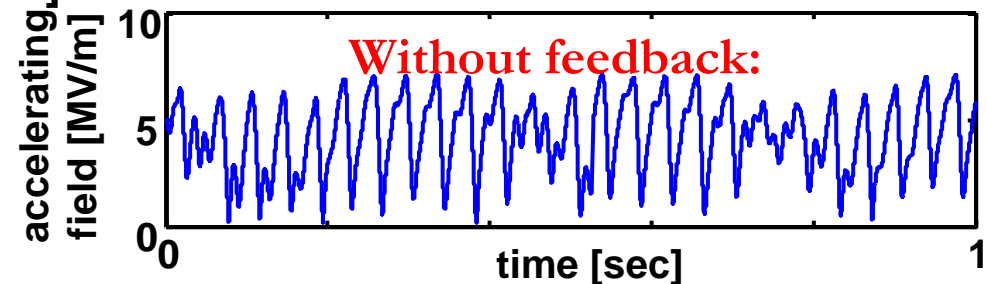



Cavity control for SC linacs (ERL & ILC)



CLASSE

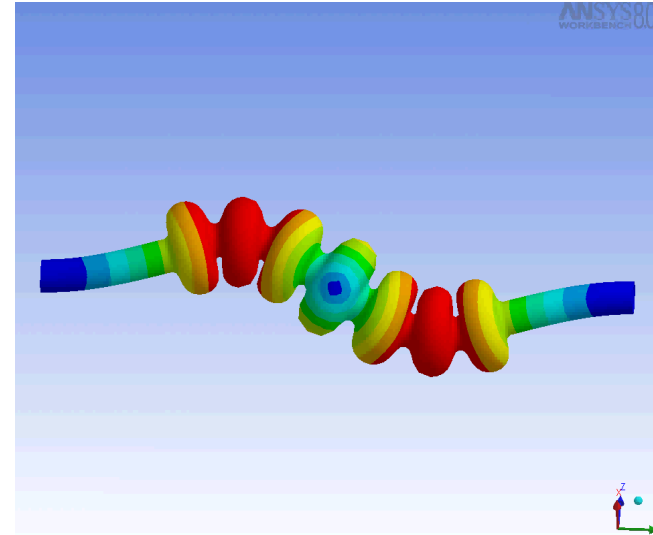
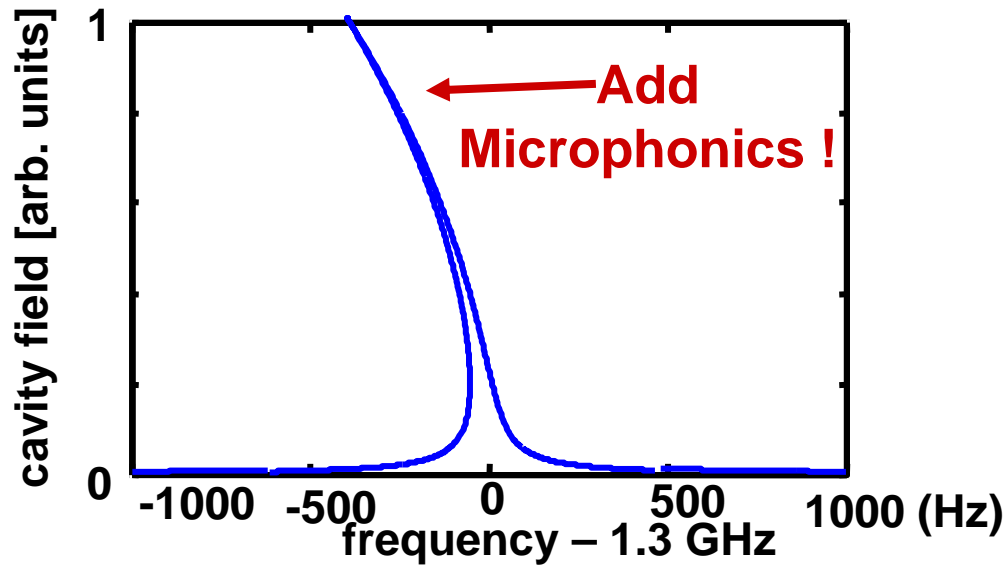

- Run cavity with lowest possible bandwidth for ERL.
- But frequency stabilization becomes very critical.

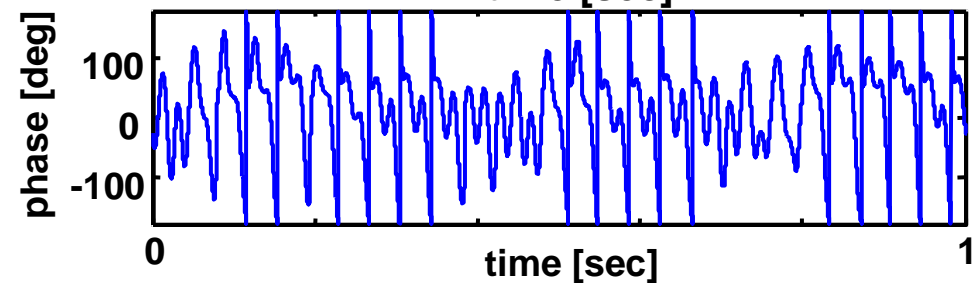
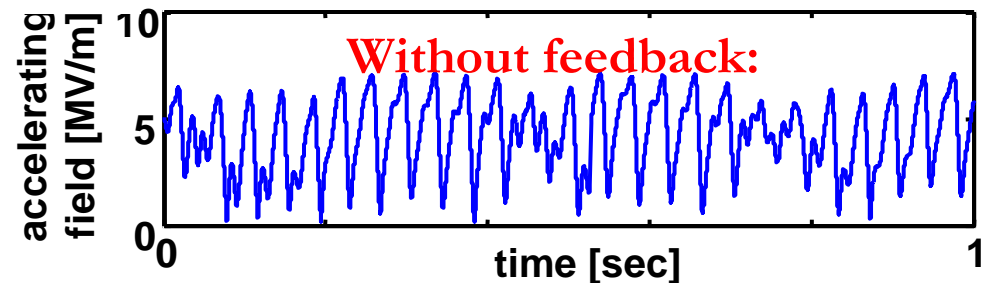



Cavity control for SC linacs (ERL & ILC)



CLASSE

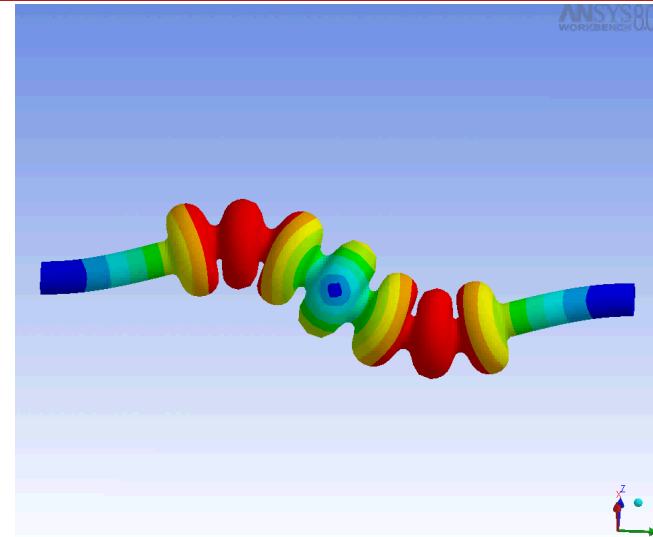
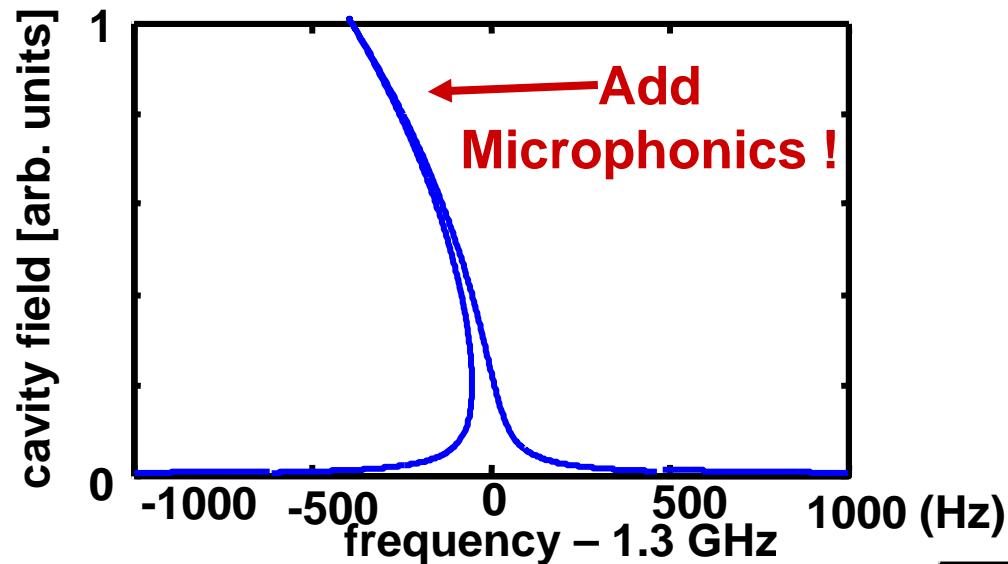

- Run cavity with lowest possible bandwidth for ERL.
- But frequency stabilization becomes very critical.

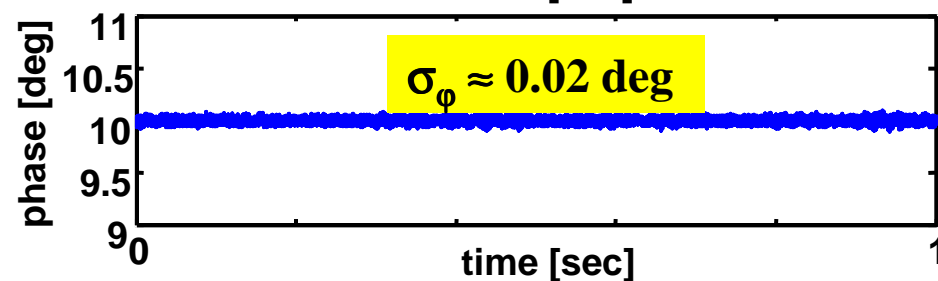
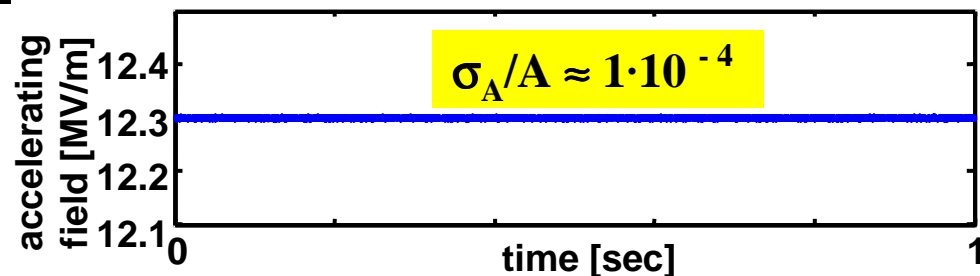



Vibration measurements



CLASSE

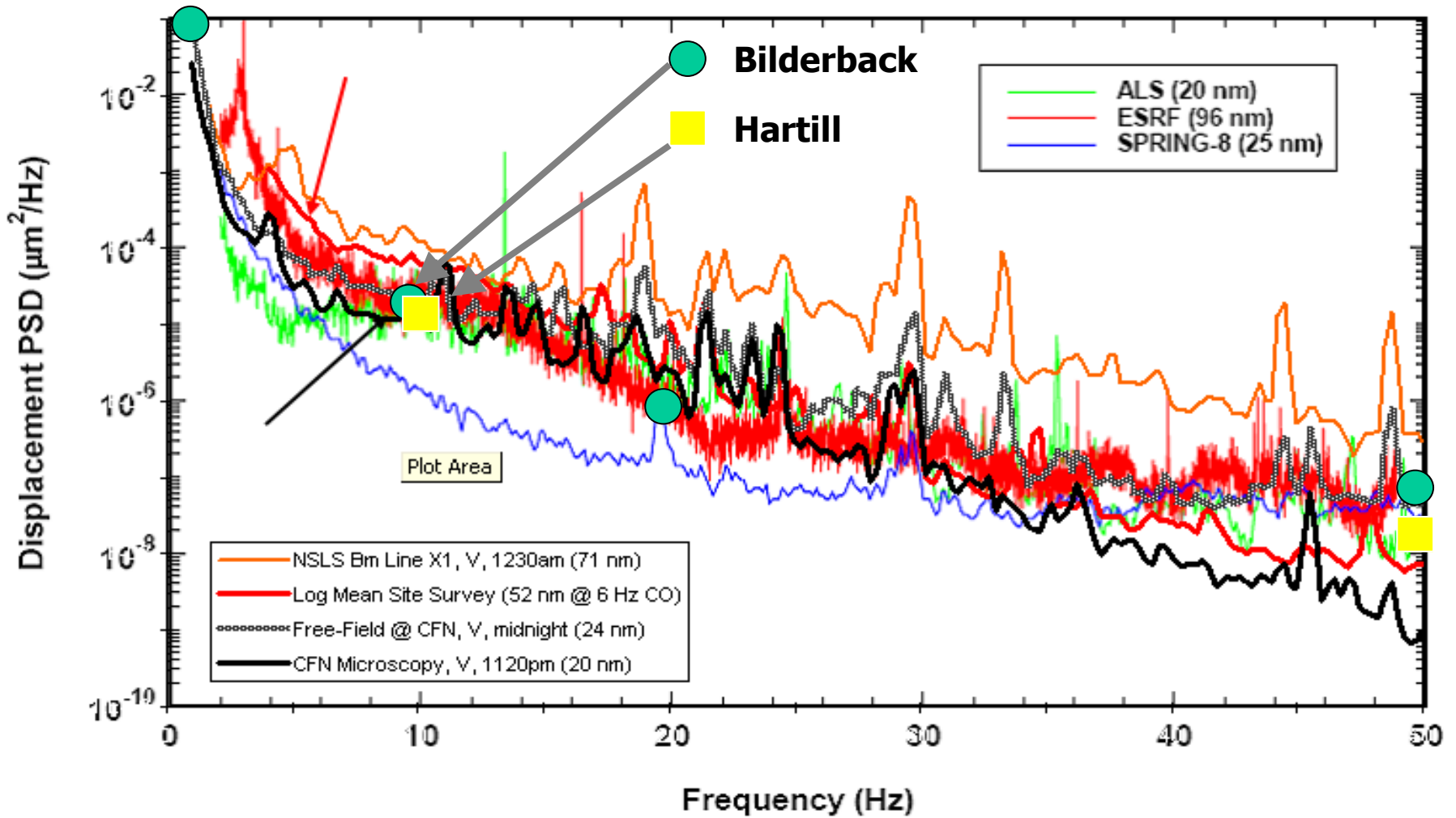



BBU: Collective Instabilities

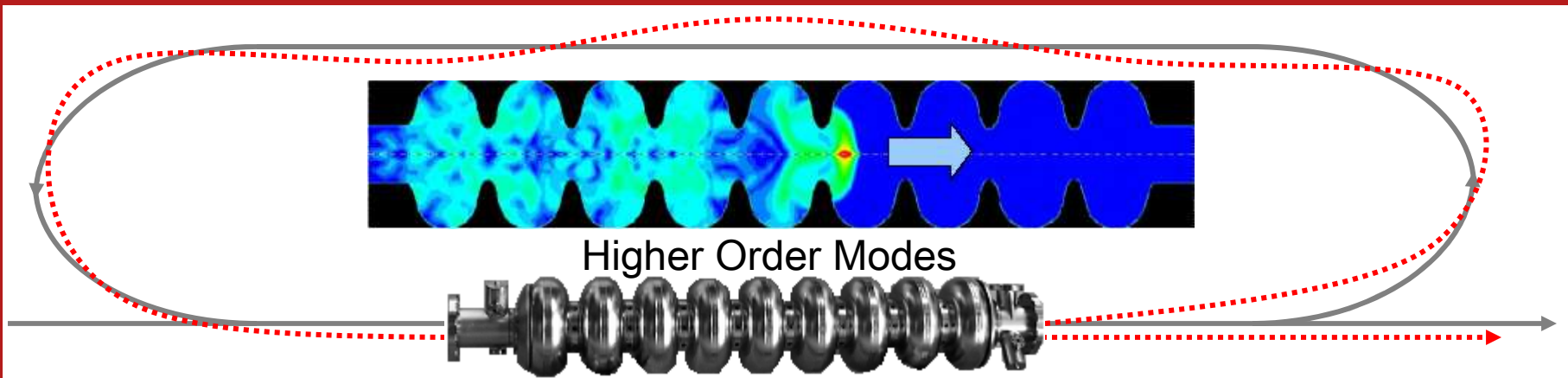

$$V_x(t) = T_{12} \frac{e}{c} \int_{-\infty}^t W_x(t-t') V_x(t'-t_r) I(t') dt'$$



BBU: Collective Instabilities

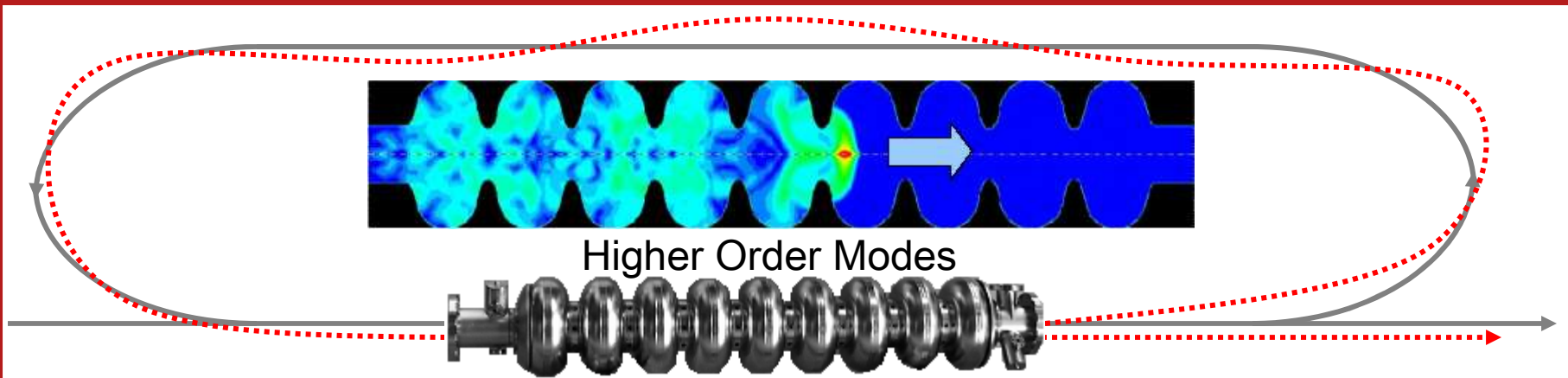

$$V_x(t) = T_{12} \frac{e}{c} \int_{-\infty}^t W_x(t-t') V_x(t'-t_r) I(t') dt'$$





BBU: Collective Instabilities

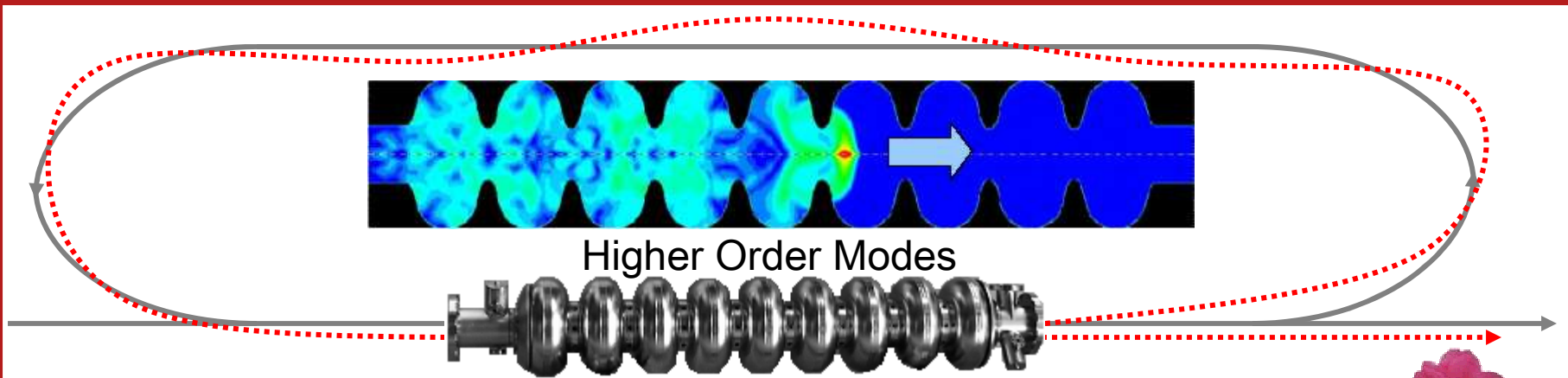

$$V_x(t) = T_{12} \frac{e}{c} \int_{-\infty}^t W_x(t-t') V_x(t'-t_r) I(t') dt'$$





HOM with BBU: Starting from Noise



CLASSE

Recall... $I_{threshold} \propto \frac{1}{Q_{HOM}}$

- Damping circuit easily reduced the Q of the 2106 MHz mode by a factor of 5
(Above a factor of about 10, the system becomes sensitive to external disturbances)
- The threshold is increased accordingly:
from 2 mA to ~10 mA

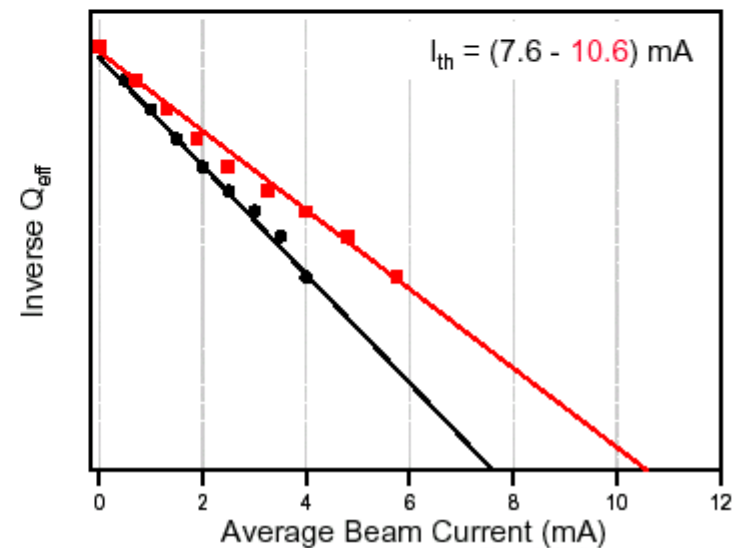
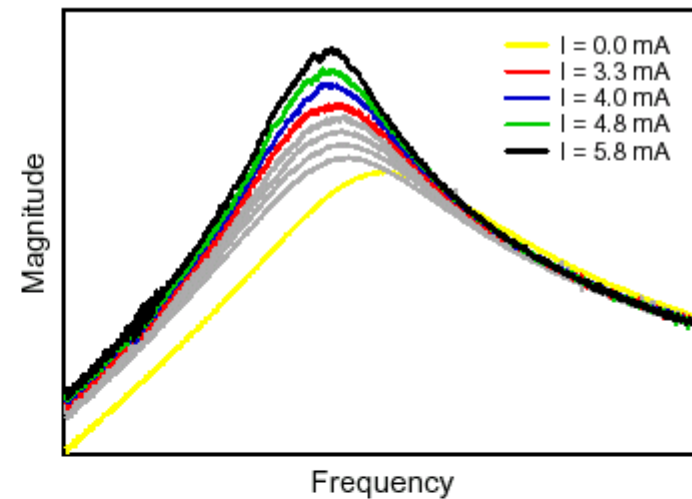
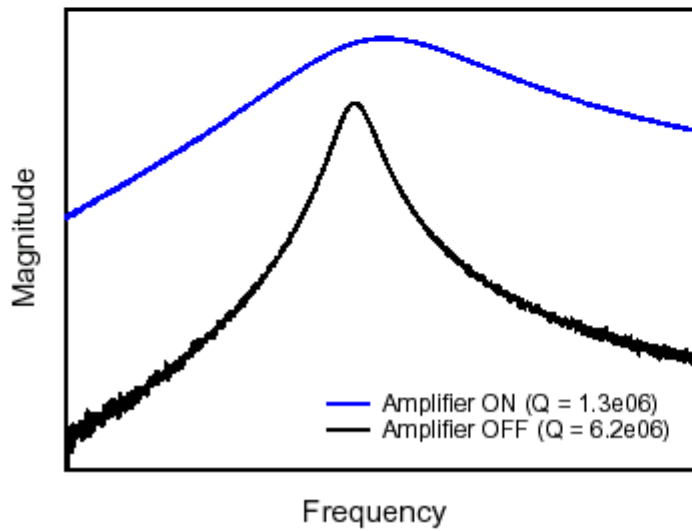



HOM absorbers a la Cornell



CLASSE

From design

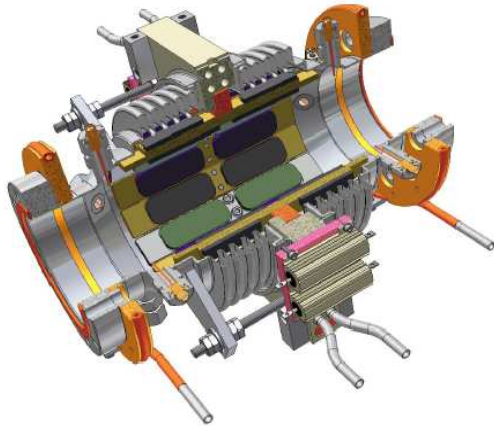

to production and



The Cornell-type HOM absorbers:

- first developed for CESR
- adopted internationally
- Refined for the ERL

HOM absorbers quickly reduce unwanted field components.

Installation, made in Cornell

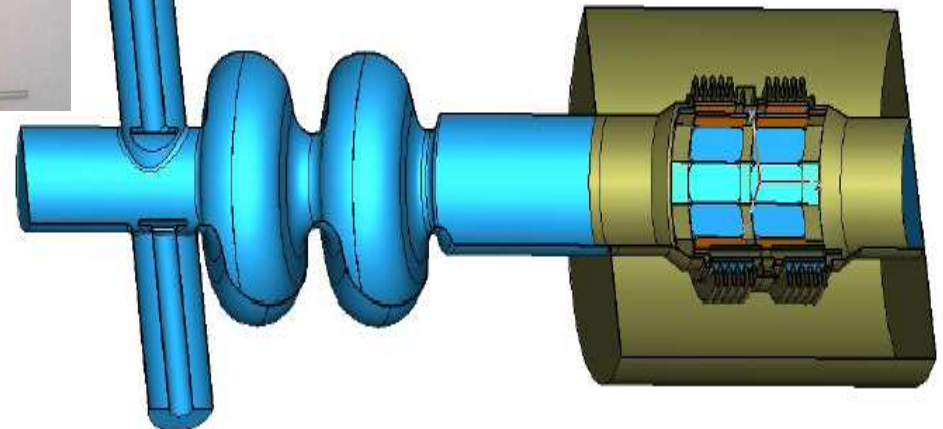



Cryogenic building



Two designs: 25 X 55 X 7m and 35 X 65 X 12m

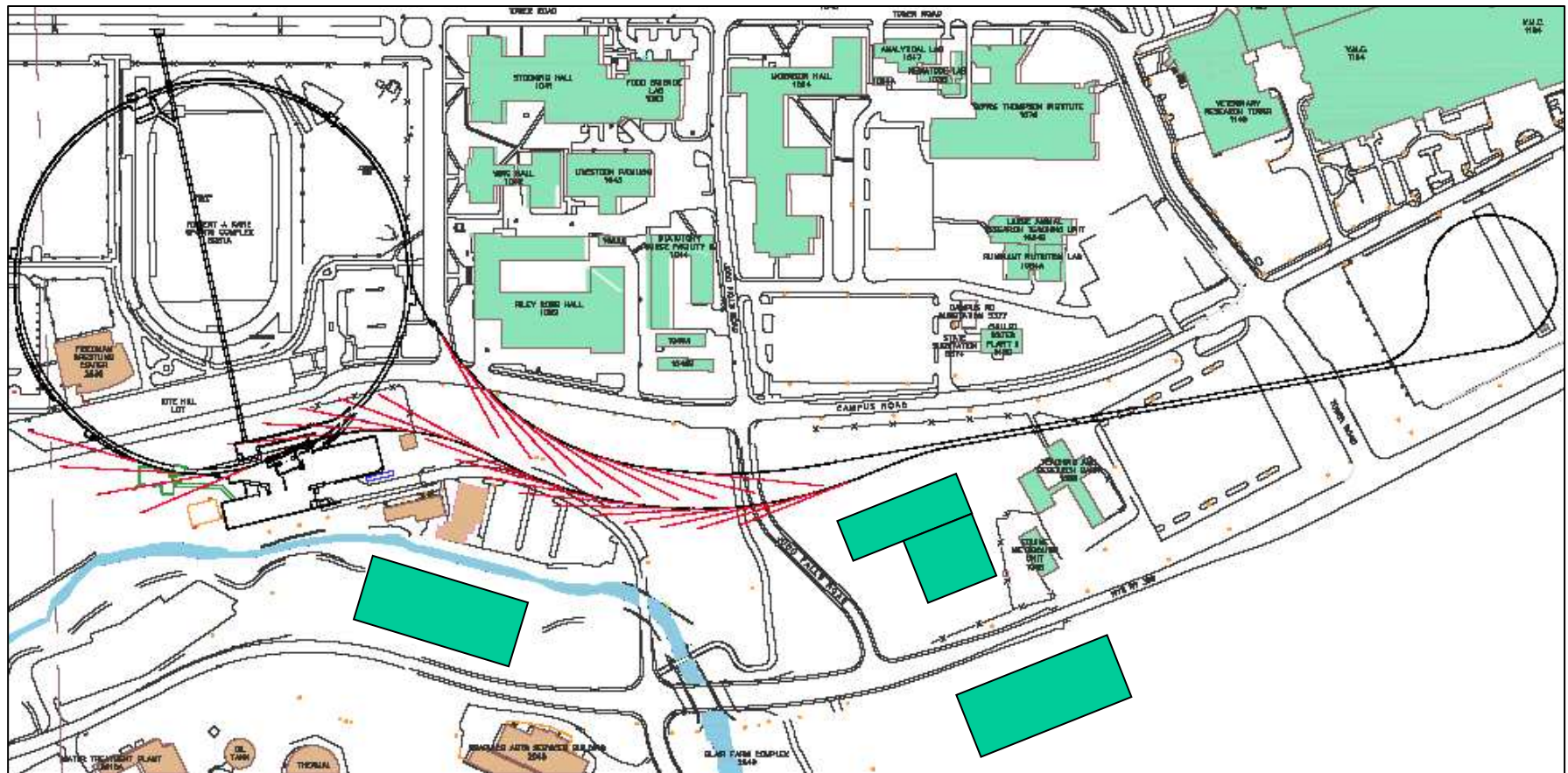



Cryogenic building



CLASSE

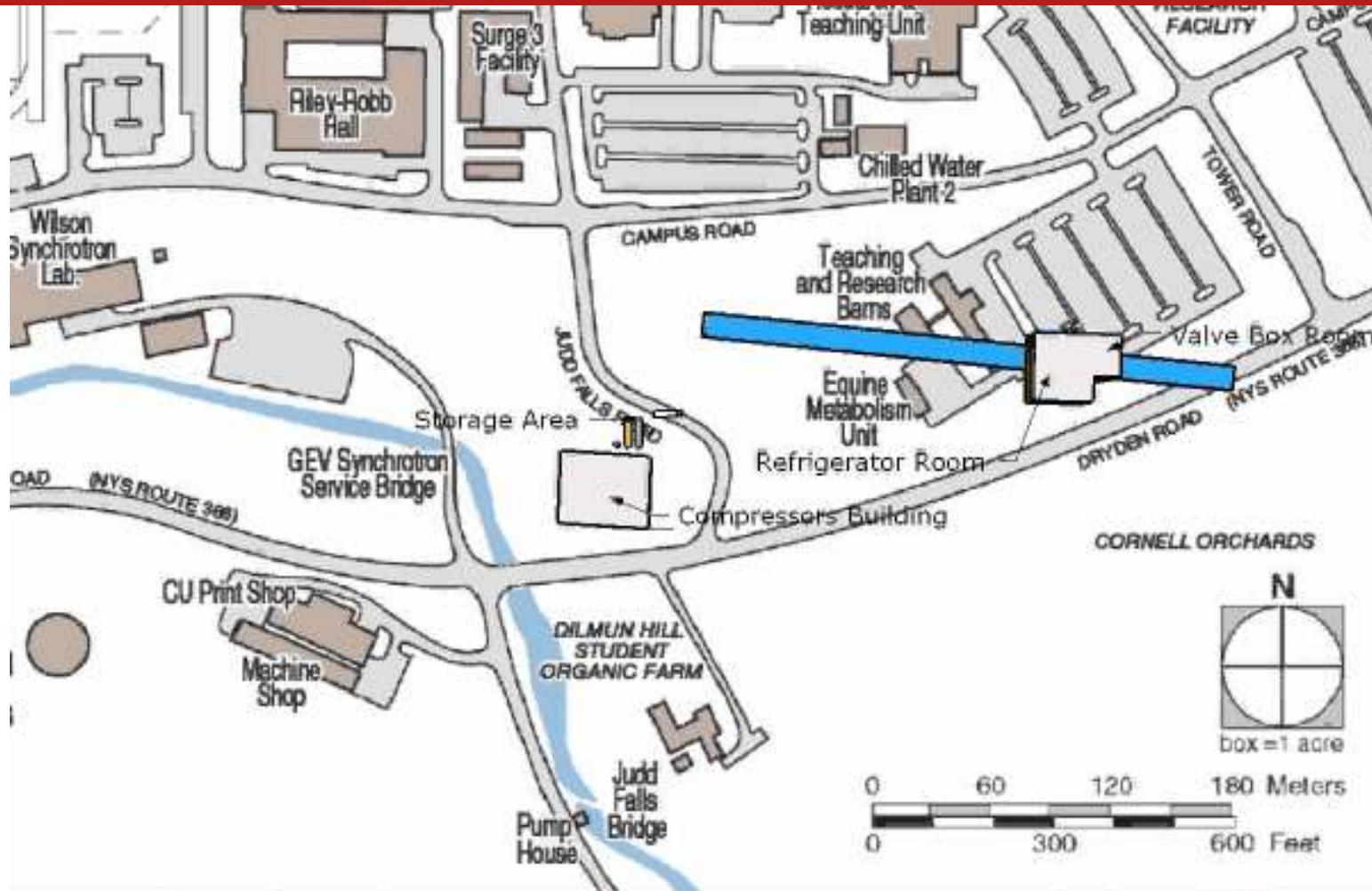



Conceptual building design



CLASSE

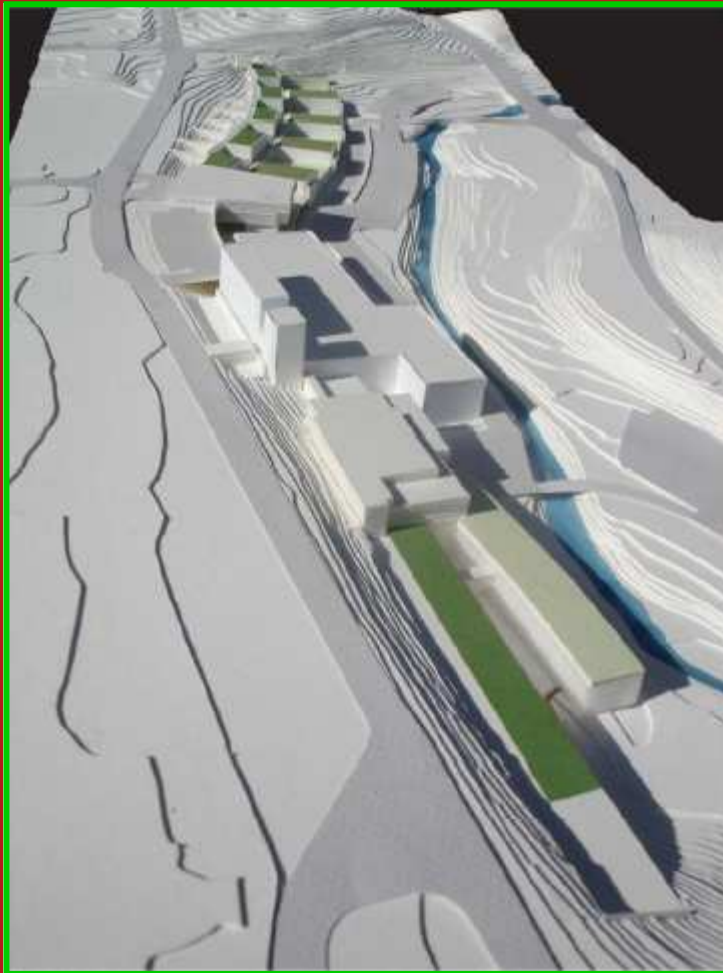

New floor space:
likely as large as existing Wilson lab.

Beamline location:
out of the hillside next to existing
Wilson lab

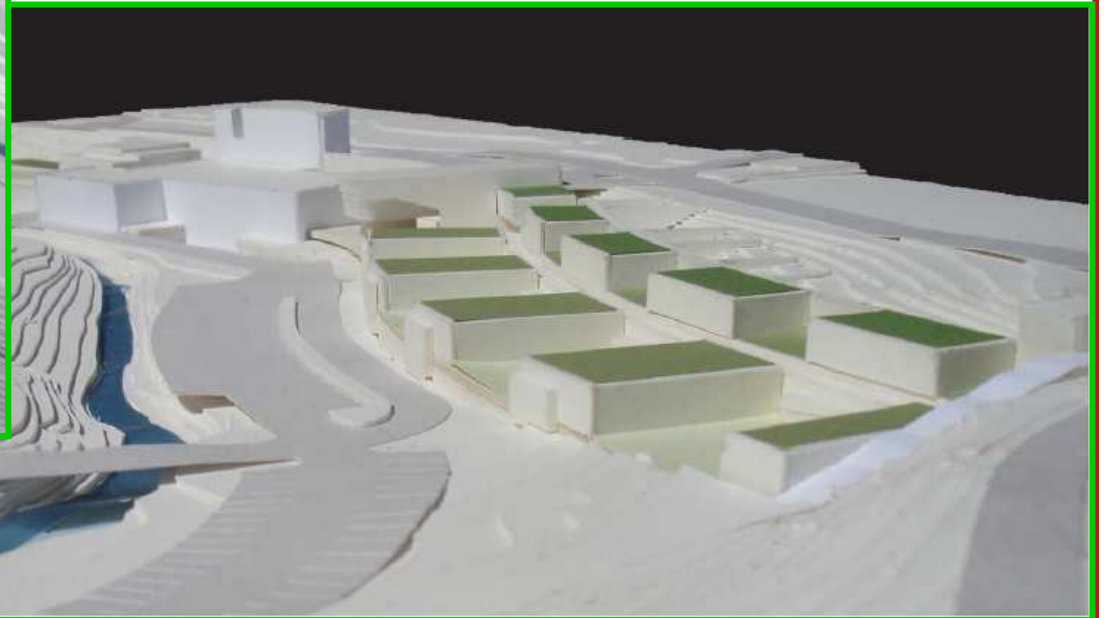



Future accelerator developments



- 1) SASE FEL development in parallel with ERL operation
(1nC, 50fs can support SASE amplification)
- 2) HGHG development in parallel with ERL operation
(1nC, 1ps can support radiator/modulator HGHG)
(1nC, 50fs can support modulator free HGHG)

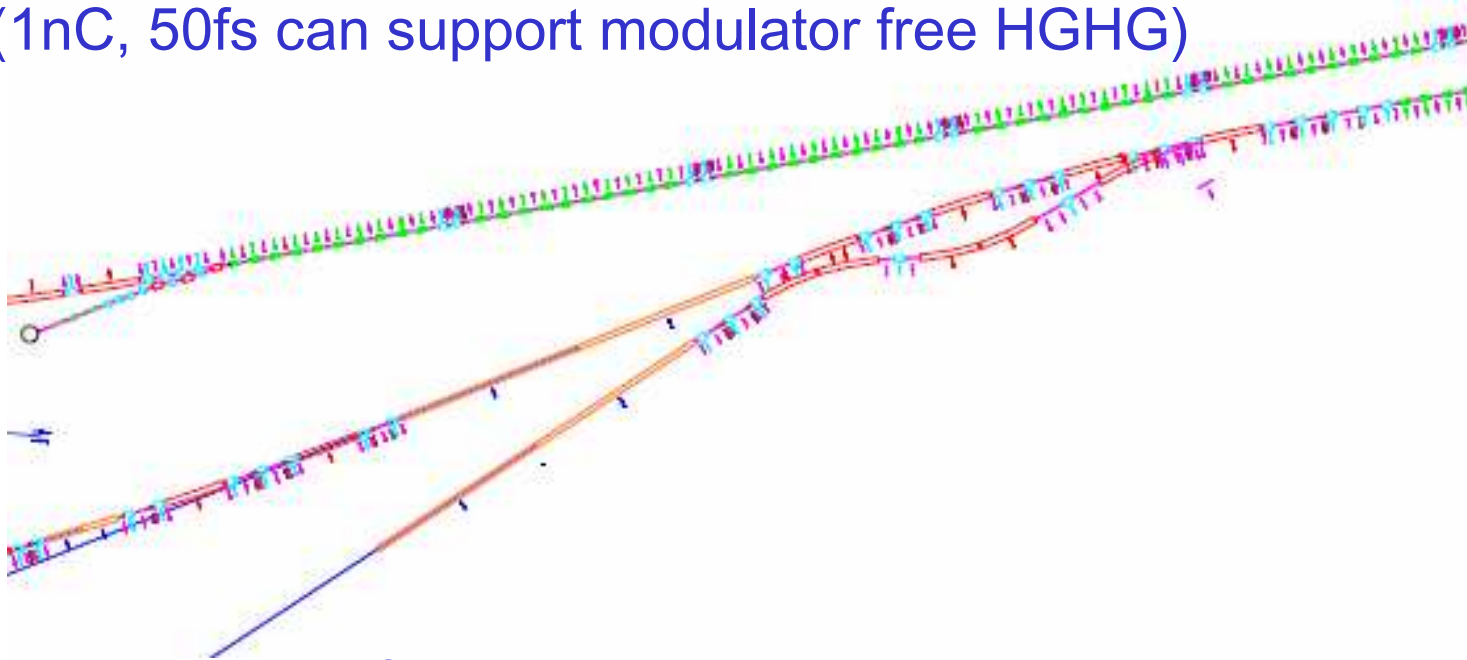

- 3) Development of higher current operation

K-J. Kim

A Novel Concept for X-Ray Optical Cavity Using Near Backscattering & Accompanying Diffraction (KJK & Shvyd'ko)

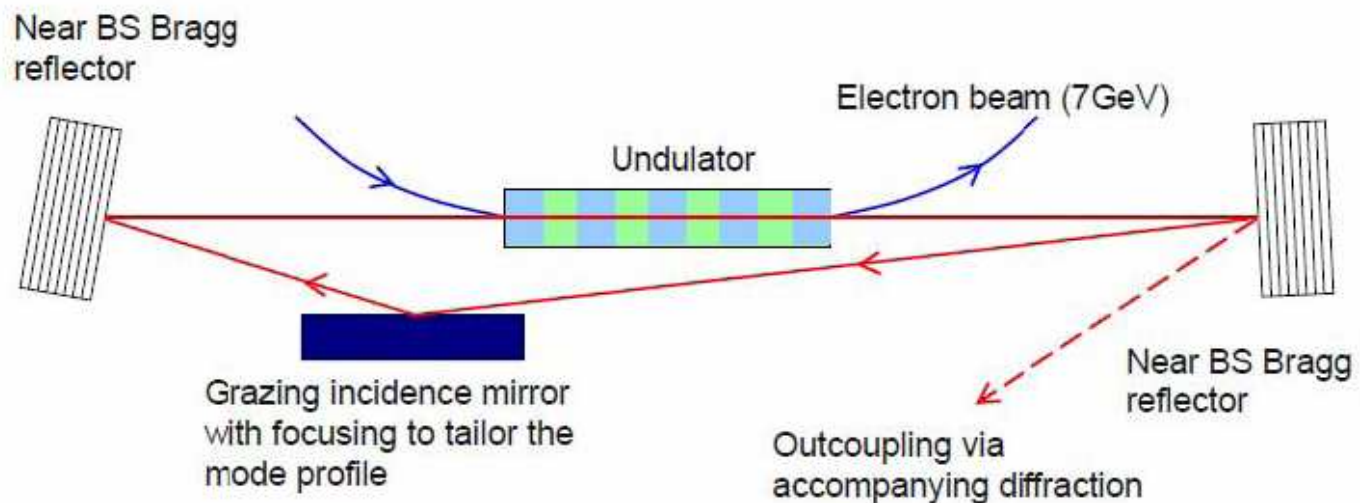

- Cornell-ERL parameters scaled to 7-GeV $\longrightarrow \varepsilon < \lambda / 4\pi$ for 1Å
(19-60pC, 2ps, $\varepsilon=6\text{pm}$, $\Delta E/E=0.02\%$)
- FEL single-pass gain $\sim 50\%$ for 60pC, $L_u=23\text{m}$ case.
- Energy spread of 0.05% (after FEL lasing) is acceptable for ERL operation.

From ERL07 Workshop



Conclusions and Contributors*



Injector parameters

User requirements for layout and beam parameters

Layout, optics considerations, ISR, CSR

Coupler kicks

Ion effects with clearing electrodes

Ion gap options

Cavity alignments, orbit correction techniques, BBU

BPM solutions for 2 beams, ERL impedances

Transverse orbit feedback considerations

x-ray loads

Gas and pressure profile

Gas and Touschek scattering, beam halo, collimation

Radiation shielding

Code developments

Ivan Bazarov, Charlie Sinclair

Don Bilderback, Dana Richter

Chris Mayes

Brandon Buckley

Christian Spethmann, Yi Xie

Bob Meller

Changsheng Song

Mike Billing, Mark Palmer

Jerry Godner, Don Hartill, John Sikora

Mike Forster

Yulin Li

Sasha Temnykh, Mike Ehrlichmann

Ken Finkelstein, Steve Gray, Val Kostroun

Dave Sagan

Cornell has an experienced team of accelerator experts who have laid out an ERL for the Cornell campus that extends the CESR ring, and have defined working modes that accommodate all considered accelerator physics issues.

* Several people contributed to more than one subject.