

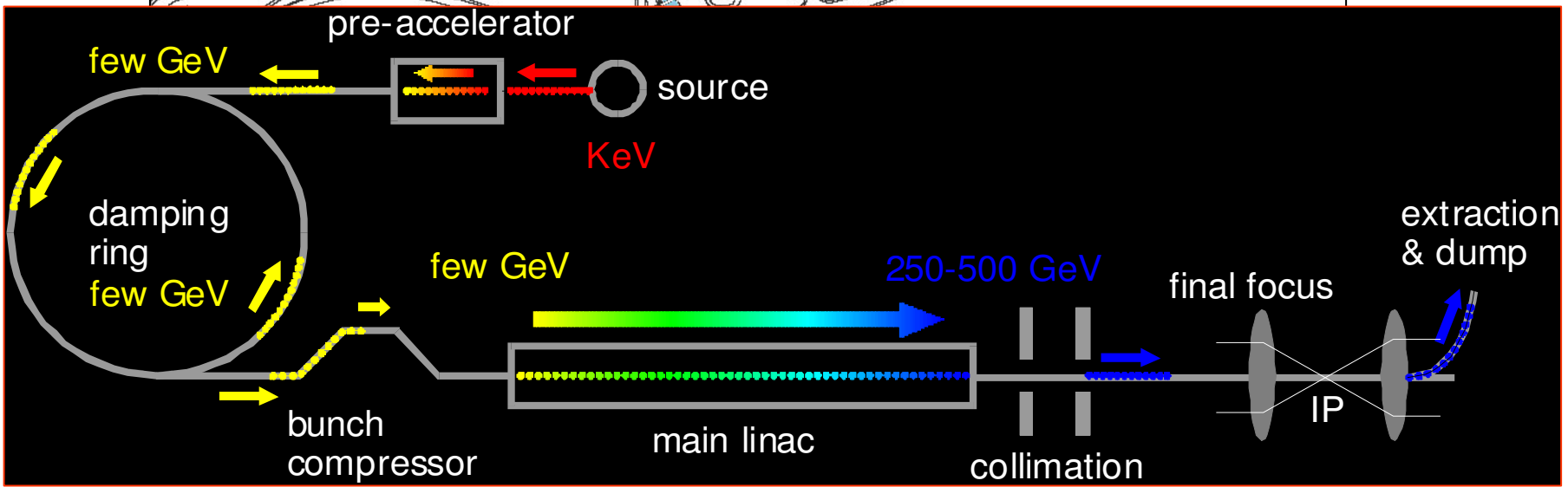

Future Accelerators: ERL and ILC

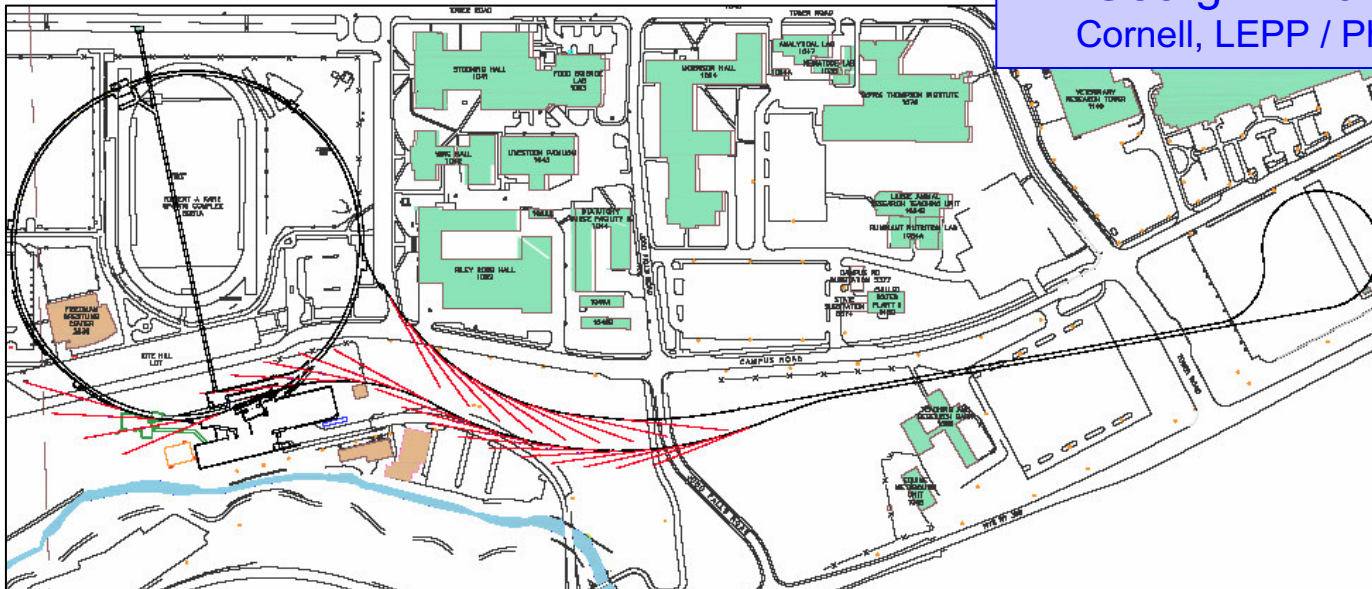

Georg H. Hoffstaetter
Cornell, LEPP / Physics Dep.





- 1932: Brasch and Lange use potential from lightning, in the Swiss Alps, Lange is fatally electrocuted

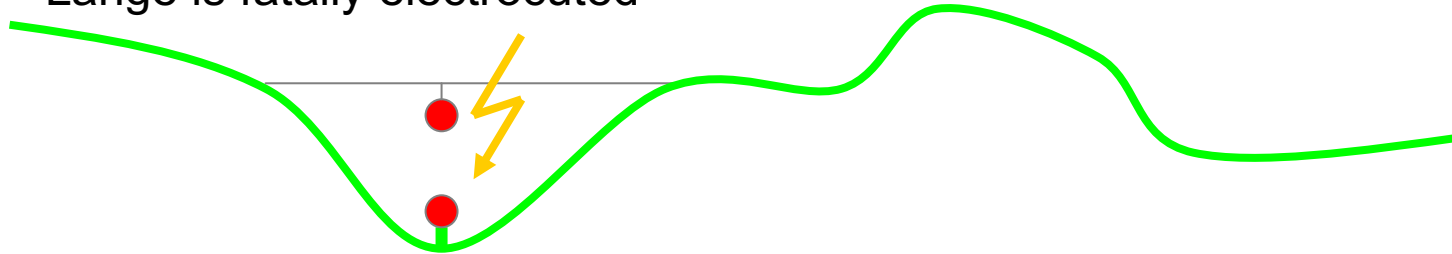

- 1934: Livingston builds the **first Cyclotron away from Berkely** (2MeV protons) at Cornell (in room B54)
- 1949: Wilson et al. at Cornell are **first to store beam in a synchrotron** (later 300MeV, magnet of 80 Tons)
- 1954: Wilson et al. build **first synchrotron with strong focusing** for 1.1MeV electrons at Cornell, 4cm beam pipe height, only 16 Tons of magnets.
- 1965: **First paper on Linear colliders and ERLs**
- 1979: 5GeV electron positron collider CESR (designed for 8GeV)
- Currently:
 - CESR operation and optimization for the CLEO experiment
 - CESR operation and optimization for CHESS
 - ERL prototyping facility (ERL e-source and injector linac)
 - ERL and CESR upgrade to an ERL
 - ILC design, simulations, damping ring studies with CESR



Synchrotron Radiation @ Cornell



CHES & LEPP

- 1947: **1st** detection of synchrotron light at General Electrics. Soon advised by D.H.Tombouliau (Cornell University)
- 1952: **1st** accurate measurement of synchrotron radiation power by Dale Corson with the Cornell 300MeV synchrotron.
- 1953: **1st** measurement of the synchrotron radiation spectrum by Paul Hartman with the Cornell 300MeV synchrotron.
- Worlds **1st** synchrotron radiation beam line (Cornell 230MeV synch.)
- 1961: **1st** measurement of radiation polarization by Peter Joos with the Cornell 1.1GeV synchrotron.
- 1978: X-Ray facility CHES is being build at CESR
- 2003: **1st** Nobel prize with CESR data goes to R.MacKinnon



Dale Corson
Cornell's 8th president

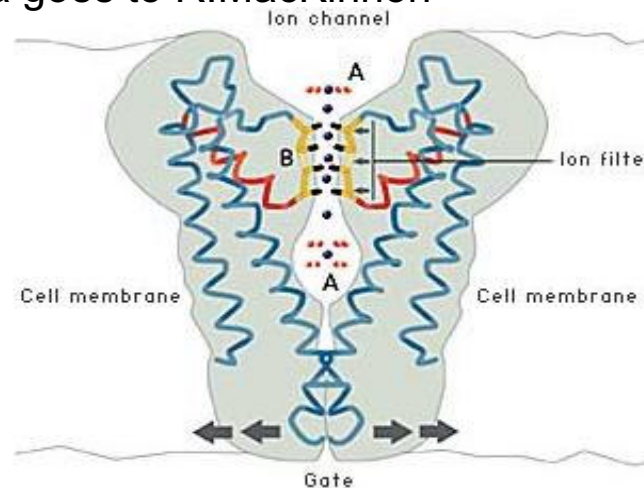

Roderick MacKinnon

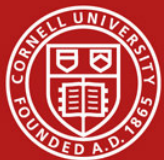

How good are ERL beam goals?



CHESS & LEPP

Transverse emittance reduction:

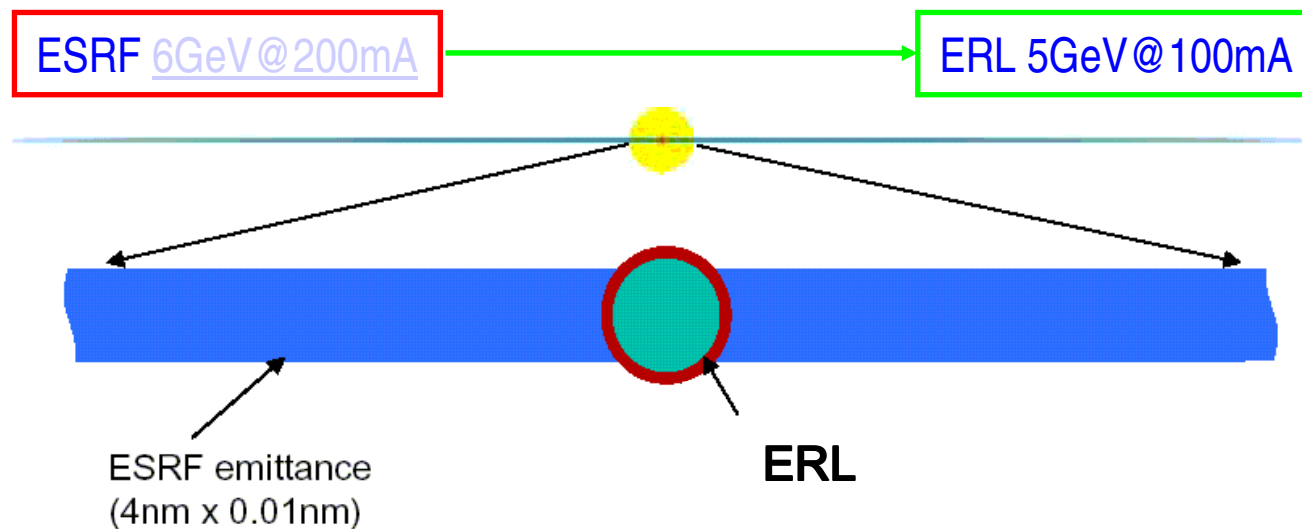

Bunch-length reduction:

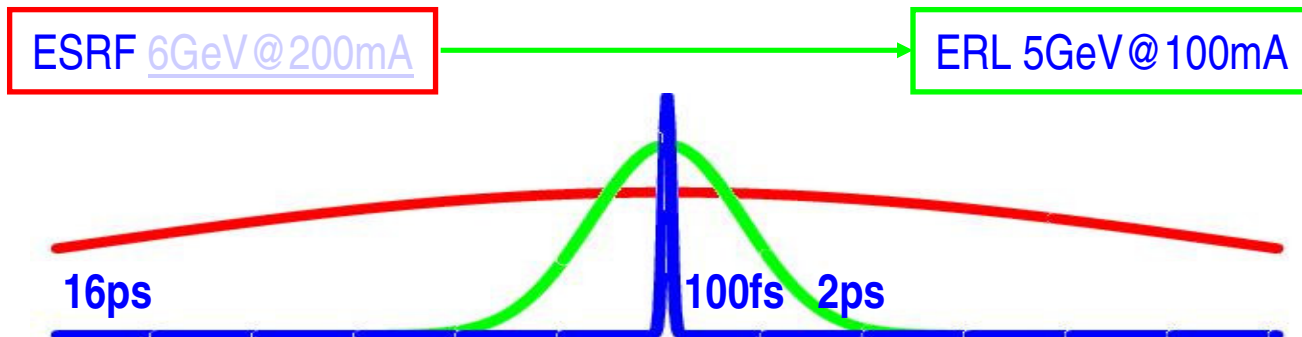



Smaller Beams and more Coherence



CHESS & LEPP

- Coherent x-ray diffraction imaging
- It would, in principle, allow atomic resolution imaging on non-crystalline materials.
- This type of experiments is completely limited by coherent flux.

Factor 100 more coherent flux for ERL
for same x-rays, or provide coherence for
harder x-rays

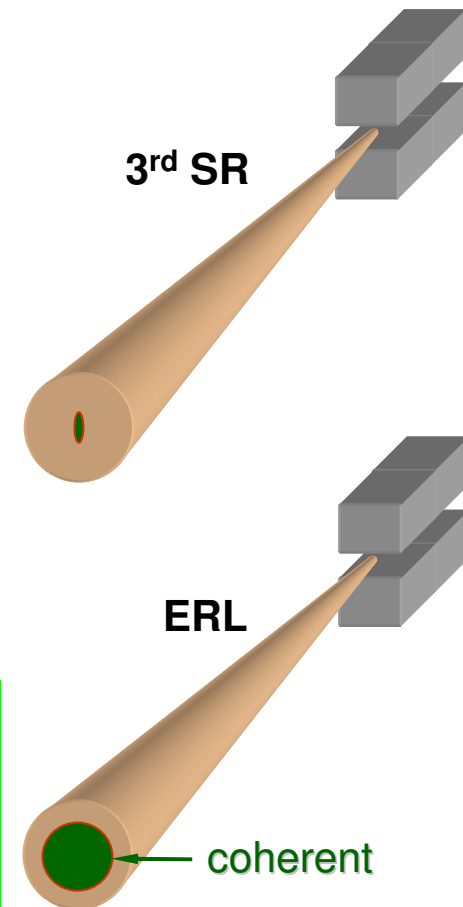

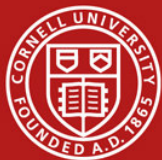

Emittance Excitation



CHESS & LEPP

Smaller dispersion

Smaller emittance

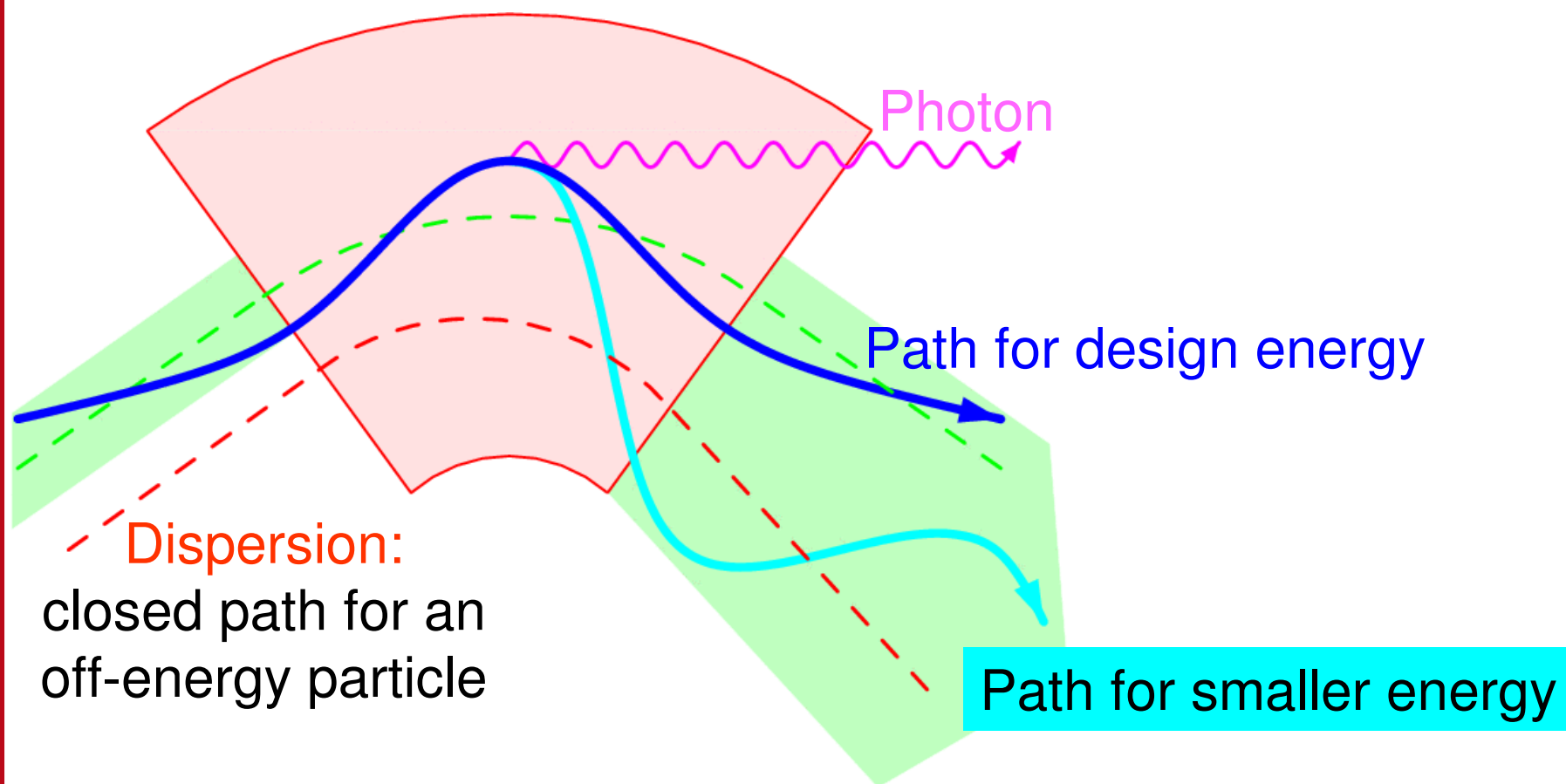

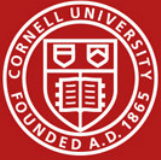

Pro and Con for an x-ray Linac



CHESS & LEPP

As compared to a ring, the beam properties are largely determined by the injector system:

- The bunch length can be made much smaller than in a ring
- Smaller emittances
- Higher coherence fraction

ESRF 6GeV@200mA



ERL 5GeV@100mA

Current of 100mA and energy of 5GeV leads to a beam power of 0.5GW !!!

The energy of the spent beam has to be recaptured for the new beam.



Pro and Con for an x-ray Linac



CHESS & LEPP

As compared to a ring, the beam properties are largely determined by the injector system:

- The bunch length can be made much smaller than in a ring
- Smaller emittances
- Higher coherence fraction

ESRF 6GeV@200mA

ERL 5GeV@100mA

Current of 100mA and energy of 5GeV leads to a beam power of 0.5GW !!!

The energy of the spent beam has to be recaptured for the new beam.



Principle of an X-ray ERL



CHESS & LEPP

X-ray analysis with highest resolution in space and time:

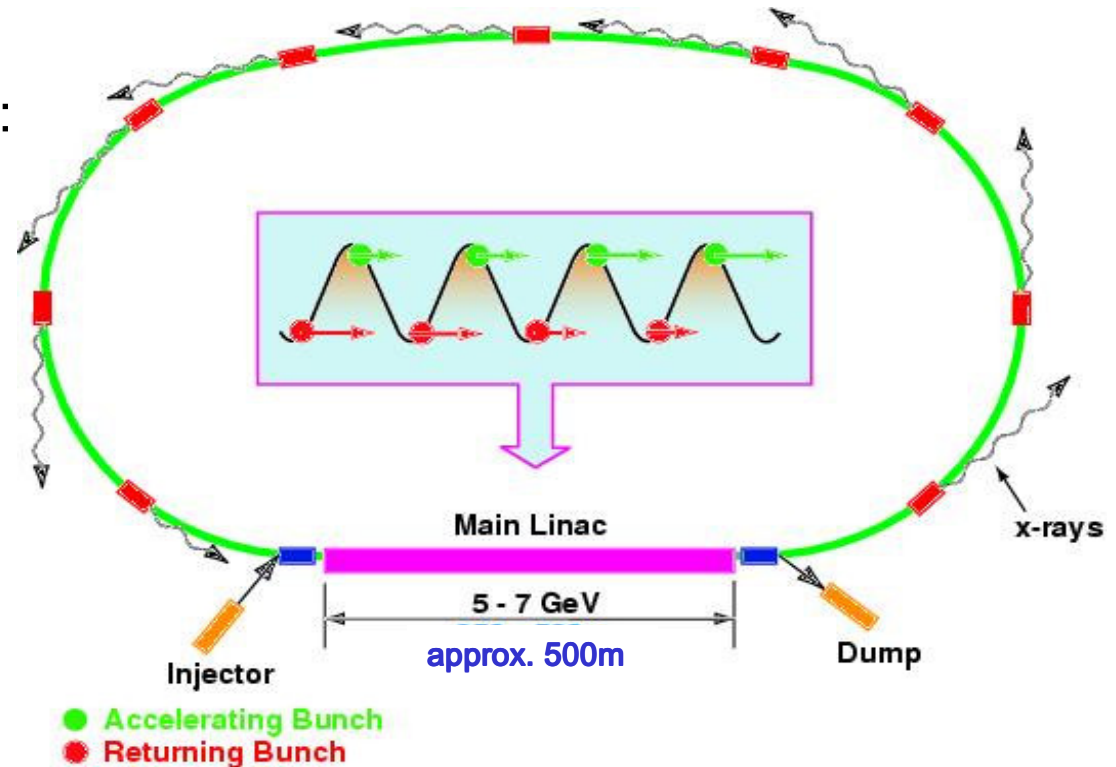

Challenges:

- Low emittance, high current creation
- Emittance preservation
- Beam stability at insertion devices
- Accelerator design
- Component properties, e.g. SRF

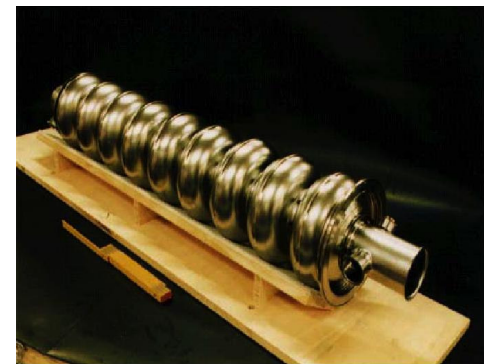



Accelerator Physics @ CESR



CHESS & LEPP





Accelerator Physics @ CCSR



CHESS & LEPP

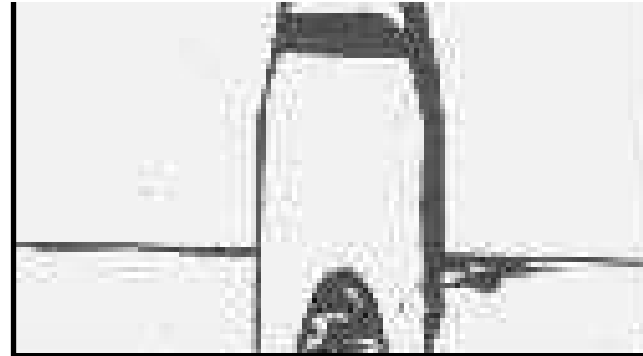
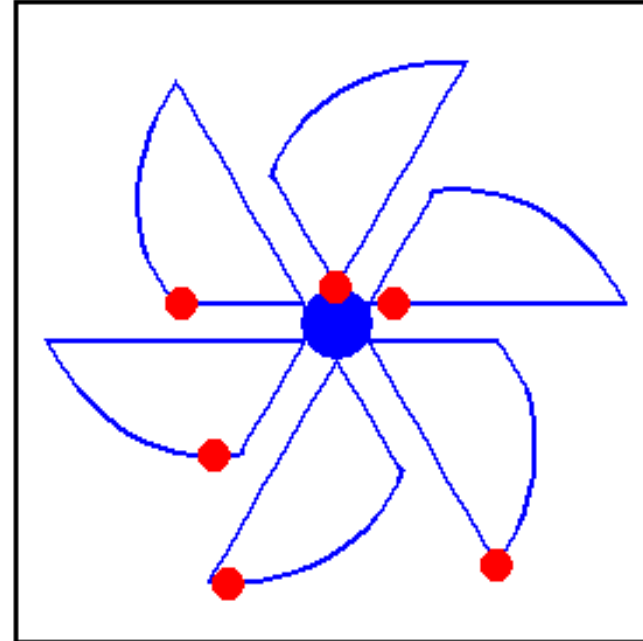



Accelerator Physics @ CERN



CHESS & LEPP

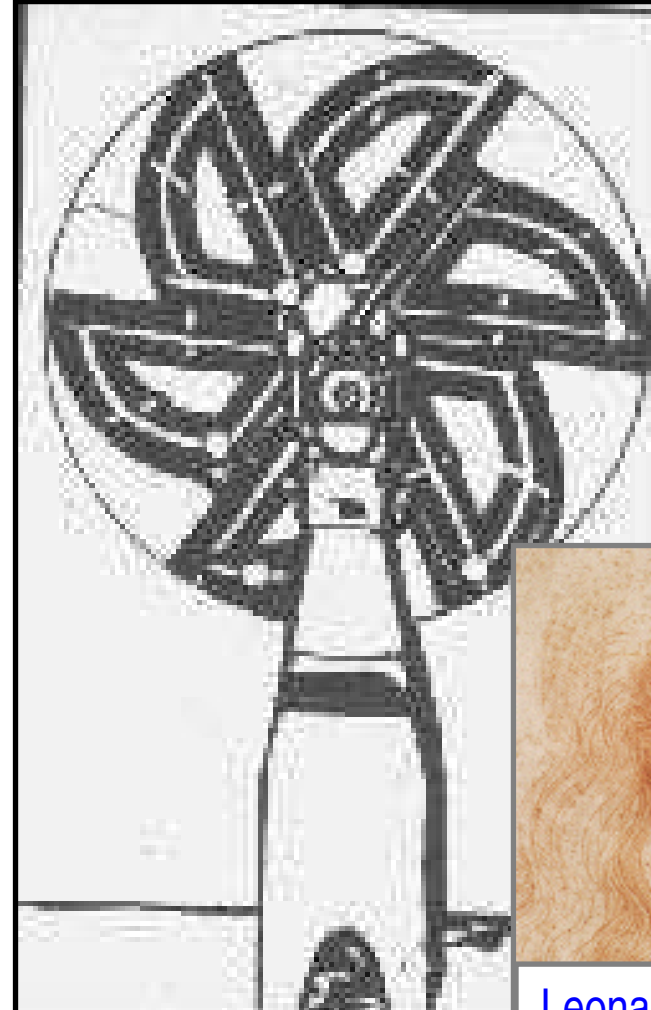
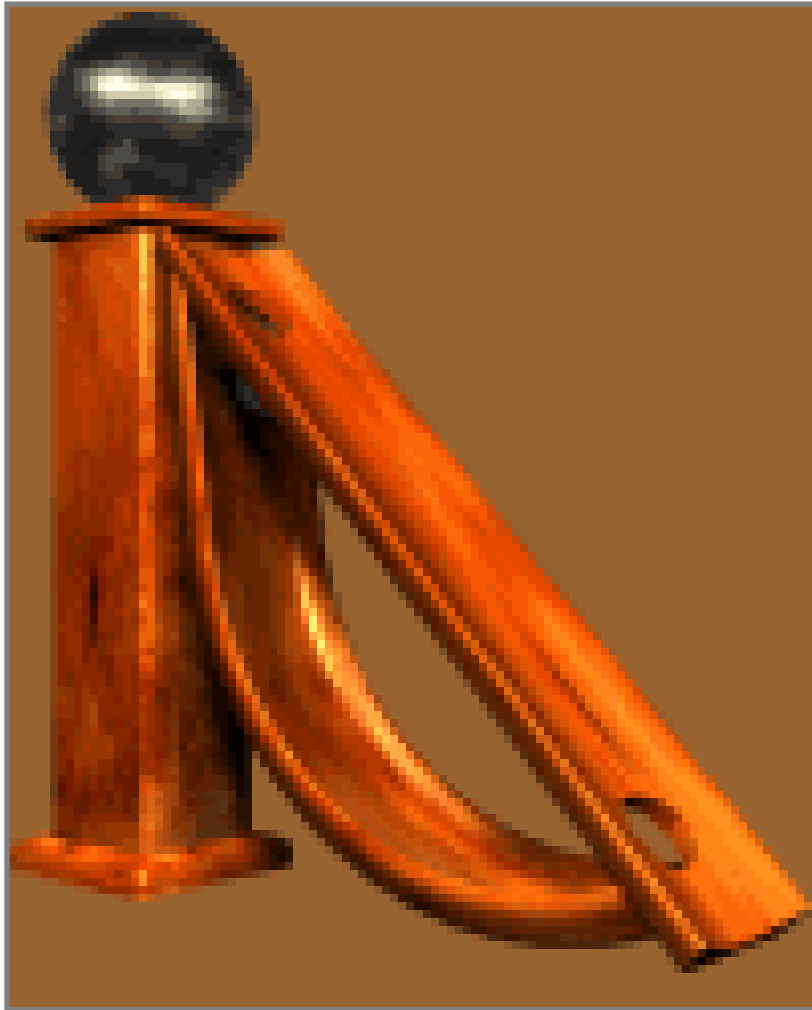

Leonardo da Vinci
(1452-1519)

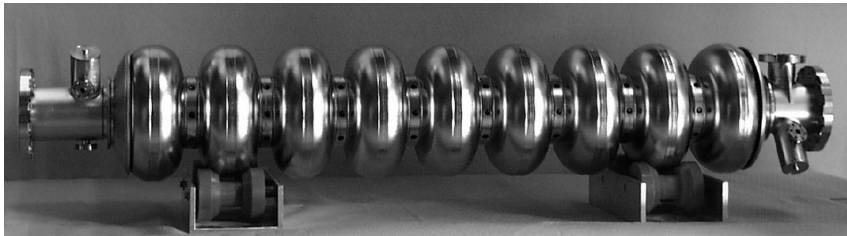

$$Q = 10^{10}$$

$$E = 20\text{MV/m}$$



A bell with this Q
would ring for a year.

- Very low wall losses.
 - Therefore continuous operation is possible.
- ↓
- Energy recovery becomes possible.

Normal conducting cavities

- Significant wall losses.
- Cannot operate continuously with appreciable fields.
- Energy recovery was therefore not possible.



The ERL principle



CHESS & LEPP

A Possible Apparatus for Electron Clashing-Beam Experiments (*).

M. TIGNER

Laboratory of Nuclear Studies, Cornell University - Ithaca, N. Y.

(ricevuto il 2 Febbraio 1965)

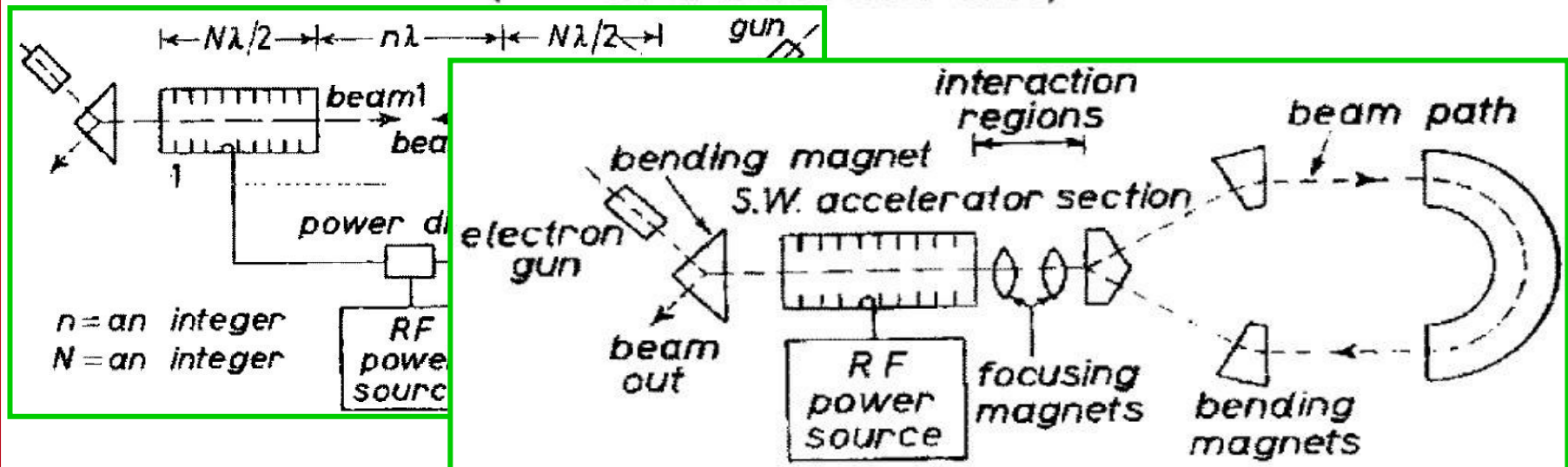

Energy recovery needs continuously fields in the RF structure

- Normal conducting high field cavities can get too hot.
- Superconducting cavities used to have too low fields.



A push-pull ERL



CHESS & LEPP

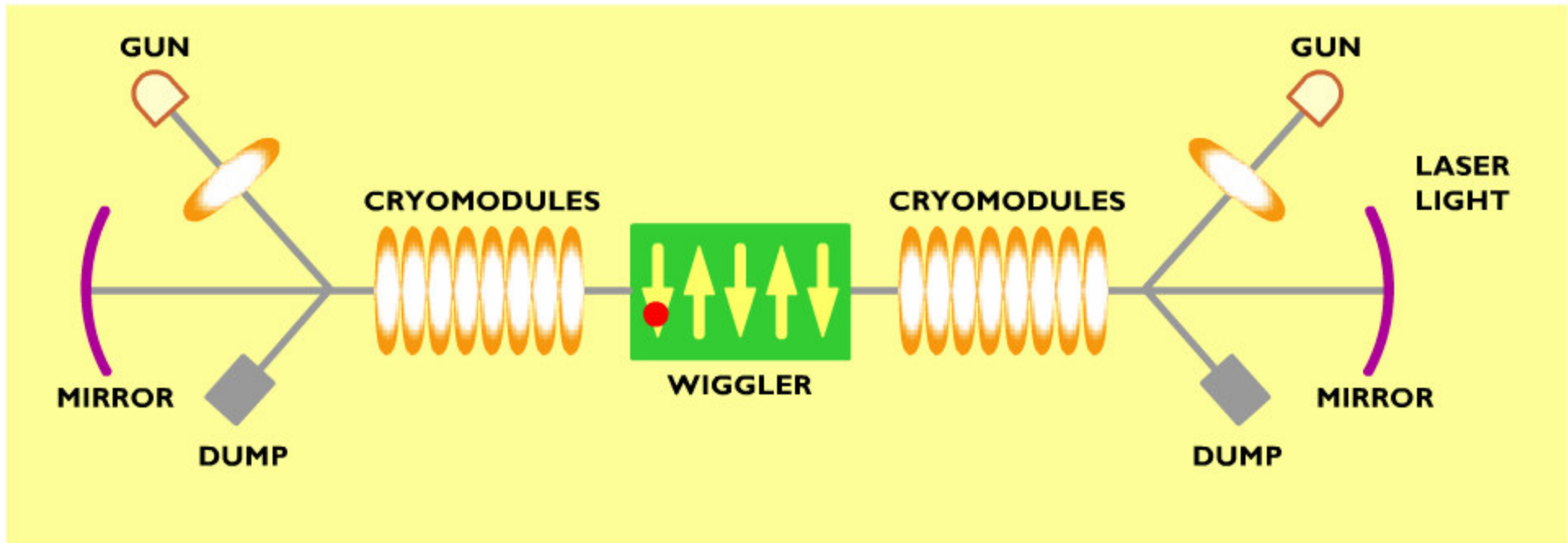

Animation by Tom Oren



Layout options: Green field design



CHESS & LEPP

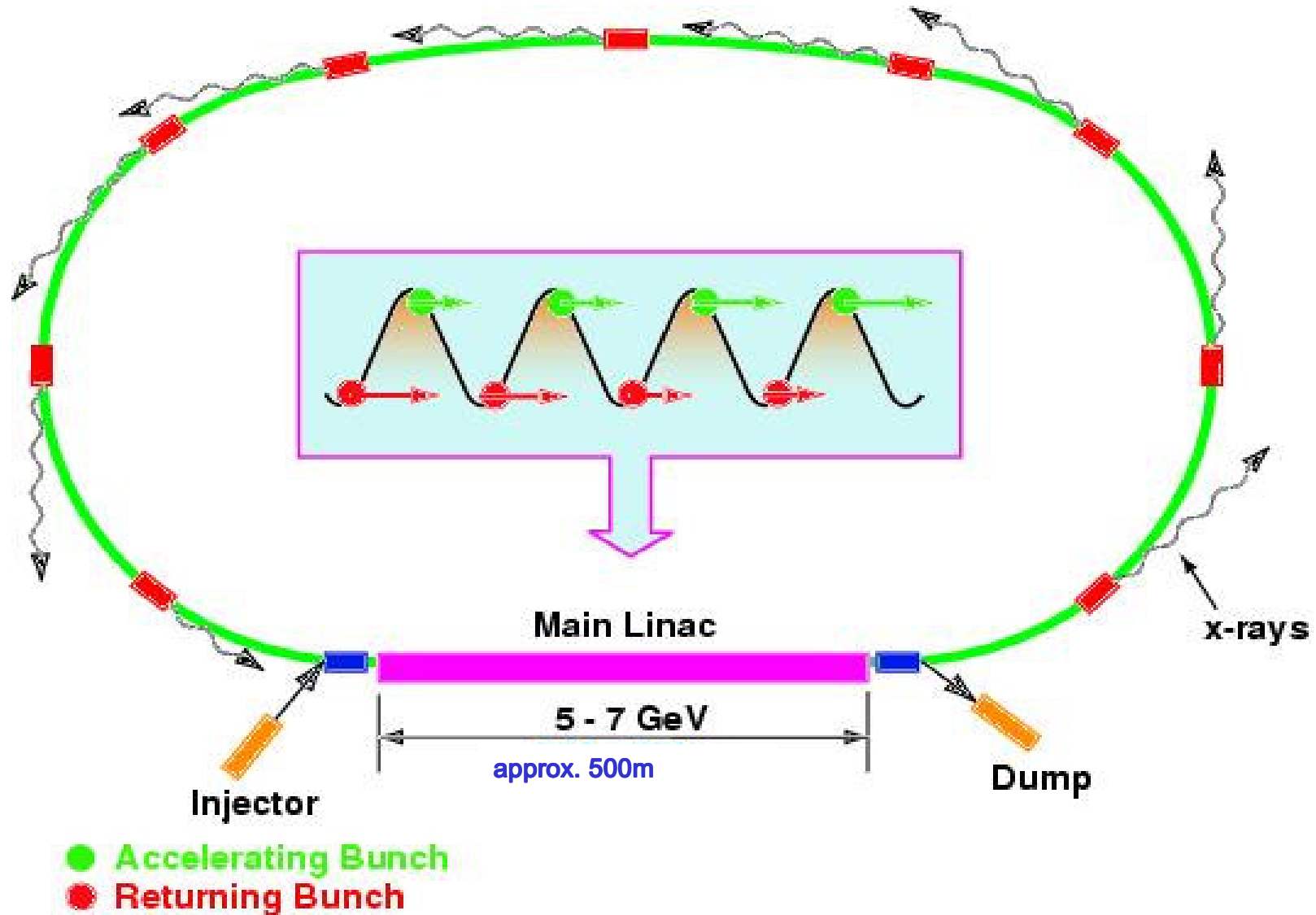



An ERL@CESR



CHES & LEPP

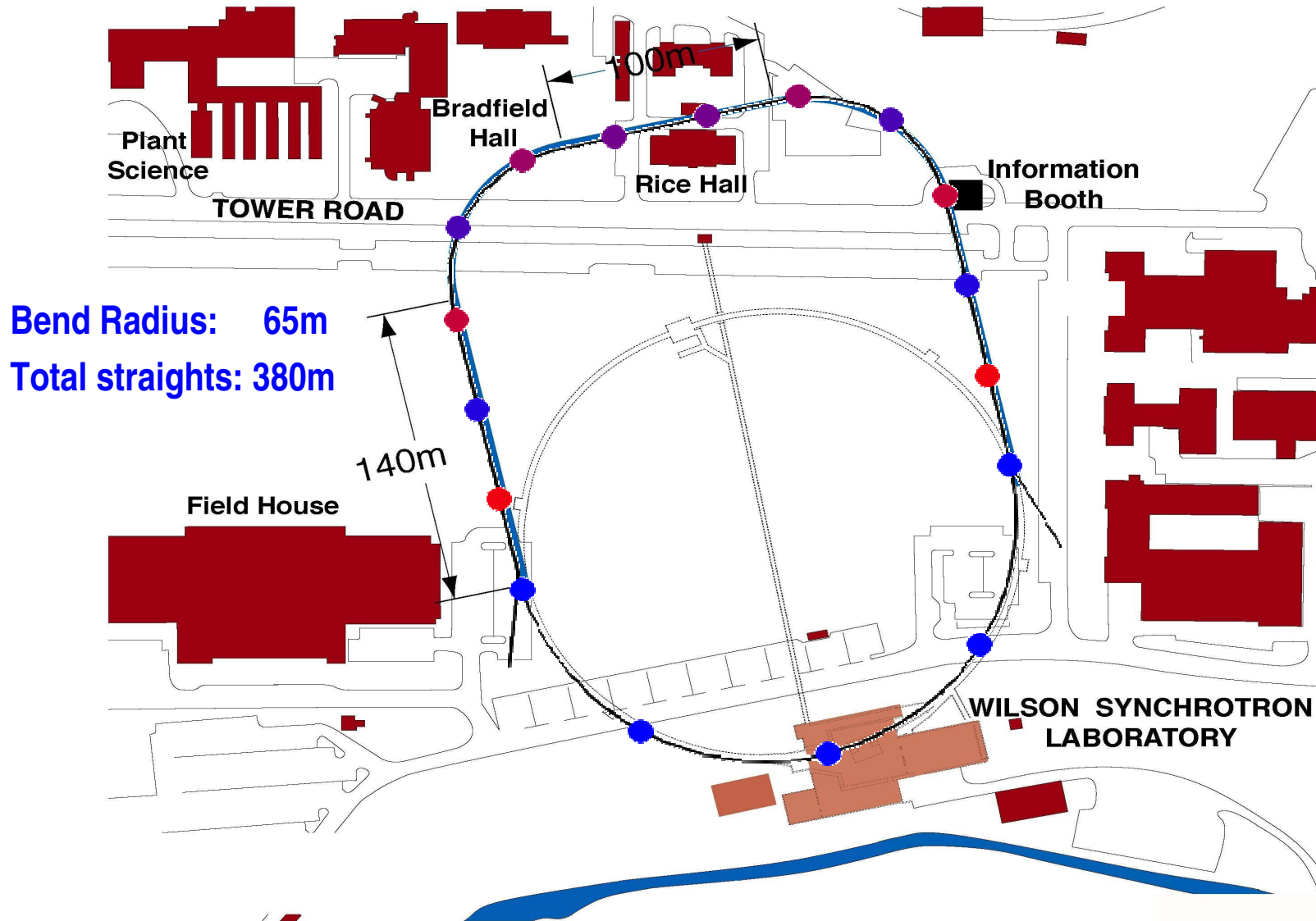

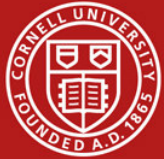

Smooth injection + commissioning loop



CHESS & LEPP

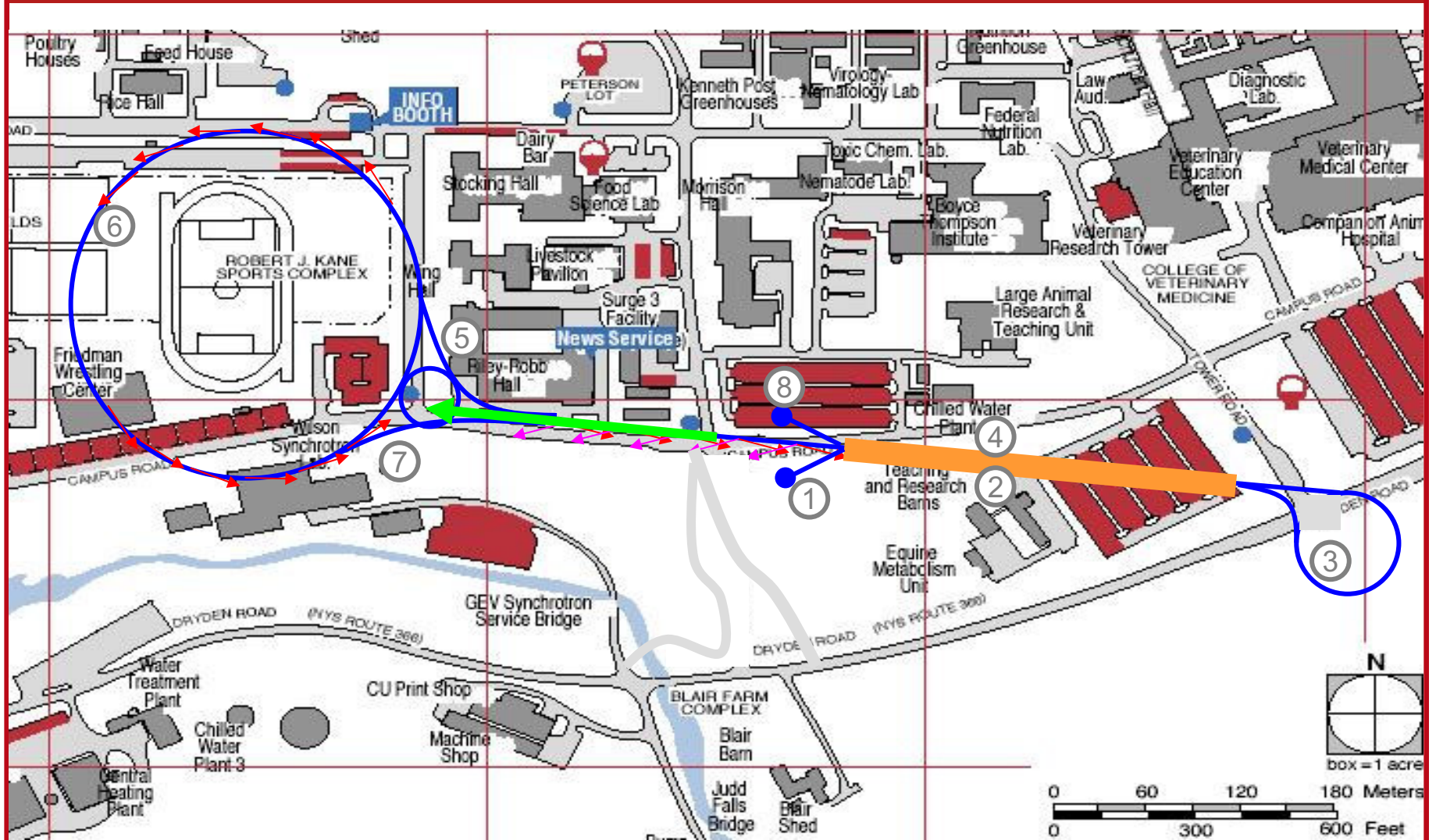



Advantages of ERL@CESR



CHESS & LEPP

- Operation of CESR and ERL test simultaneously.
- Use all of the CESR tunnel.
- Lots of space for undulators.
- Space for future upgrades, like an FEL.
- No basements of existing buildings to worry about.
- Only one tunnel for two linacs.
- Less competition, since other sights cannot offer upgrades.
- Example character for other existing light sources.



ERL@CESR design version 1.3



CHES & LEPP

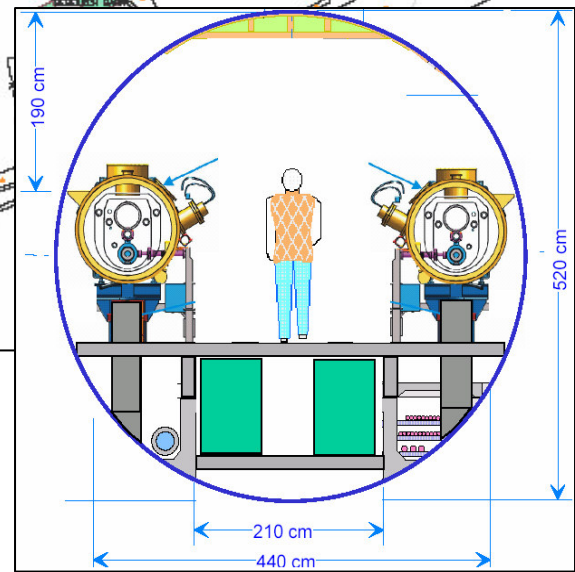
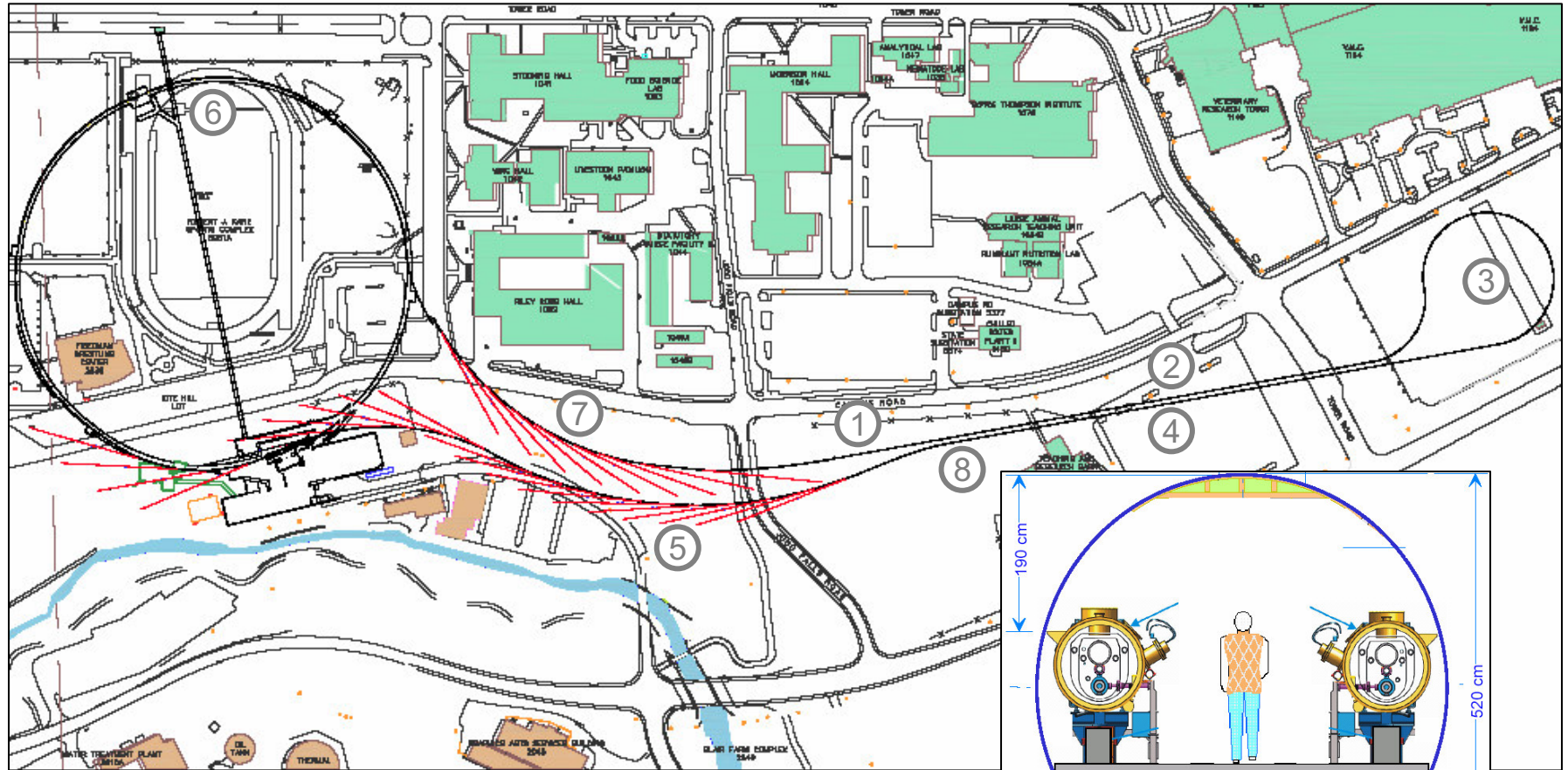



Space requirements



CHES & LEPP

Present assignable space: 87,048 sq ft
New required space: 195,000 sq ft

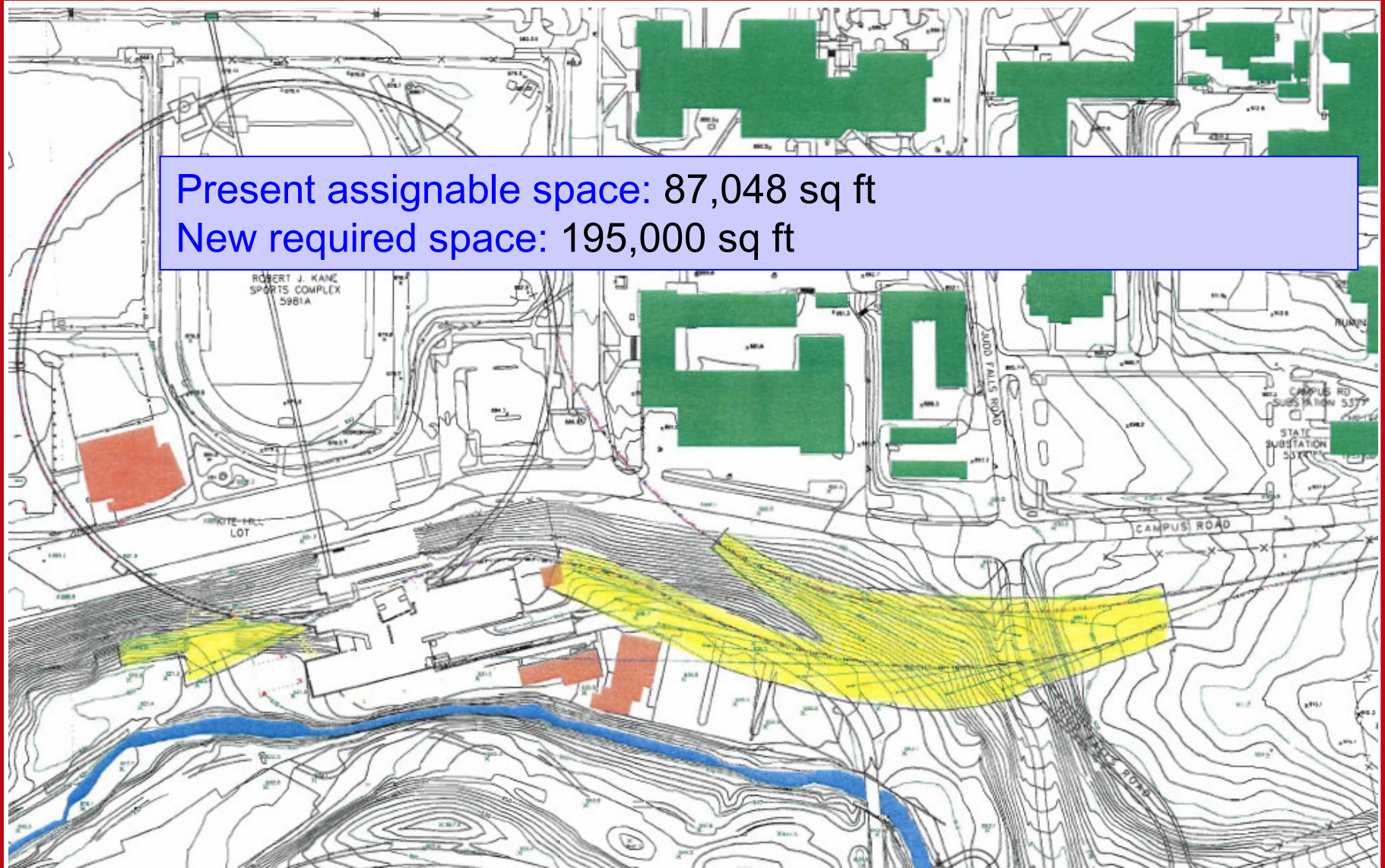



Cryogenic building



CHESS & LEPP

Two designs: 25 X 55 X 7m and 35 X 65 X 12m

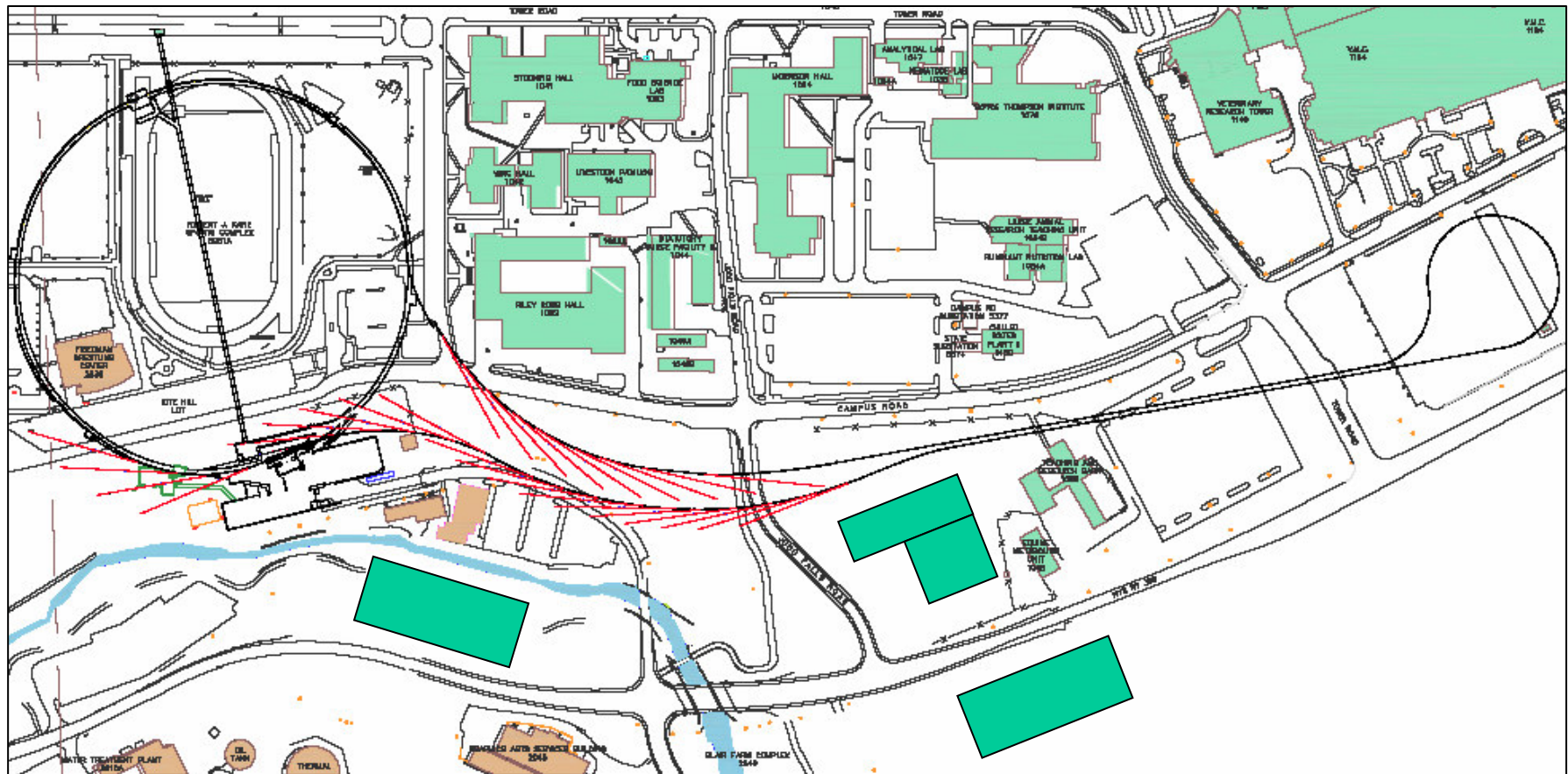



Beam requirement



CHES & LEPP

Beam transport – Beam stabilization – Component damage

In undulators:

- Specified small emittances in 6D
- Specified high current
- Specified beam size and divergence
- Specified beam direction
- Limited radiation and particle loss background
- All of these stable at all times

In all components:

- Limited HOM heating
- Limited synchrotron radiation heating
- Limited beam loss heating and radiation



Linear Optics (A – high brilliance)



CHESS & LEPP

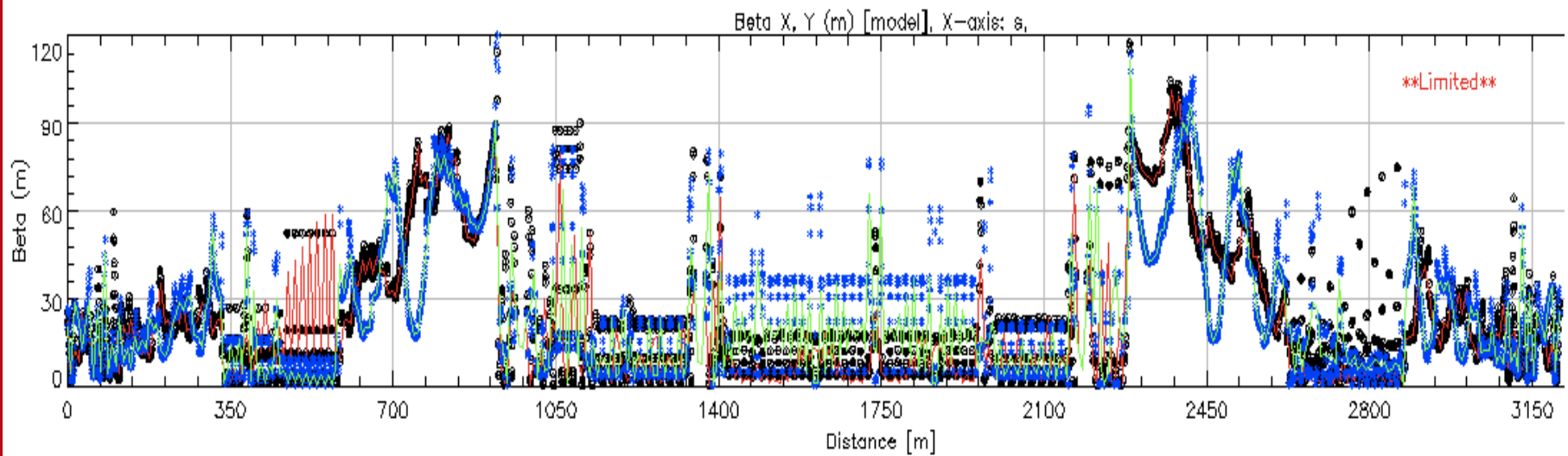
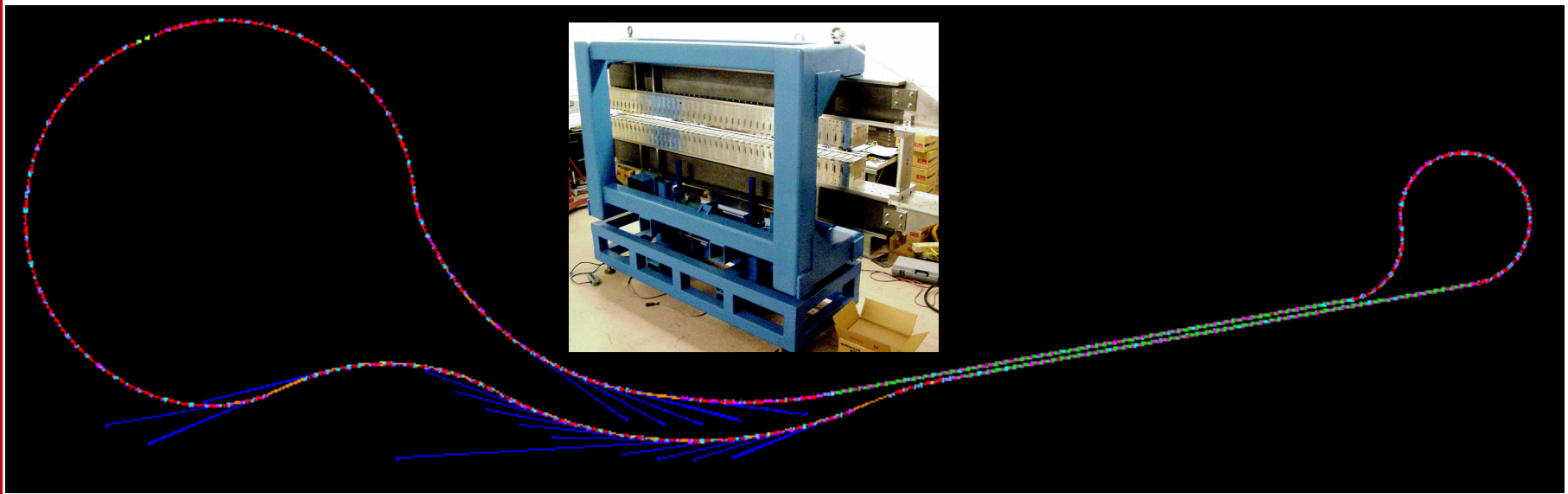



Lasing at JLAB with the ERL-FEL



CHESS & LEPP

Wiggler gap



TMPGEnc 4.0 XPress

High Reflector

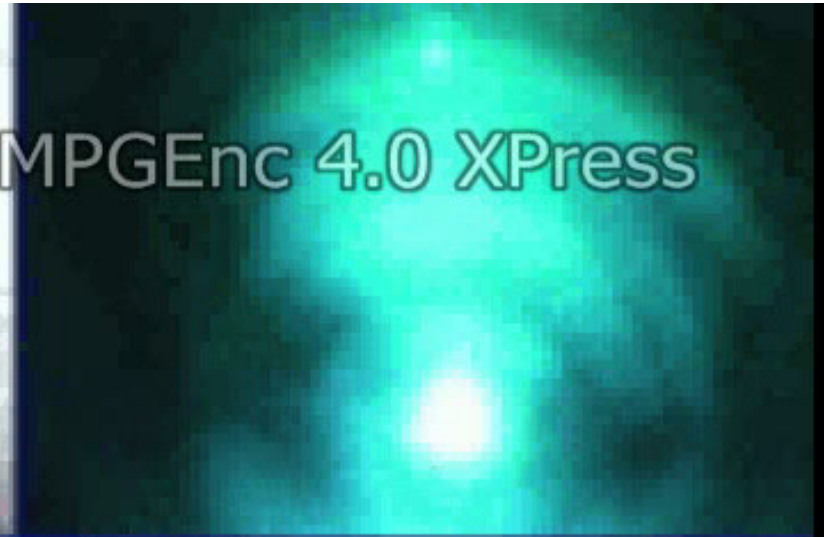

Hole Outcoupler



Beam in control room





Linear Optics (C – short pulse)



CHESS & LEPP

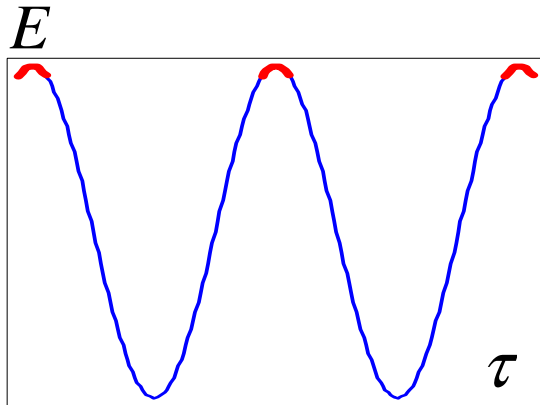



Linear Optics (C – short pulse)



CHESS & LEPP

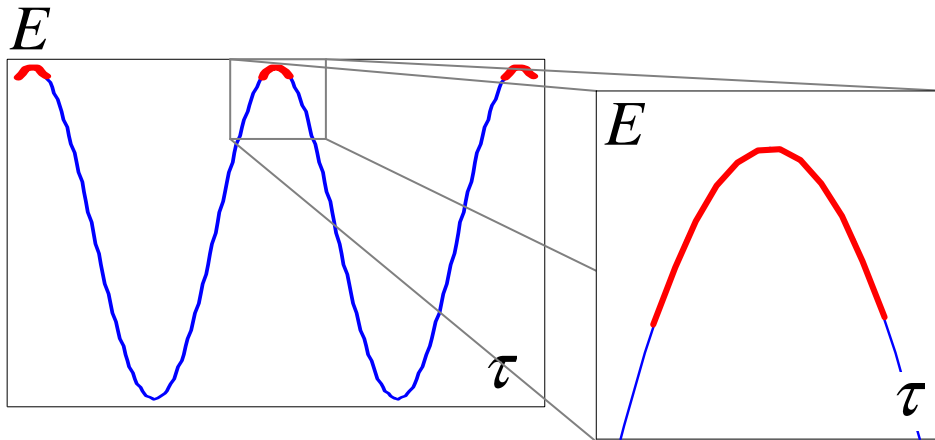

- On crest acceleration leads to long Bunches with small energy spread.

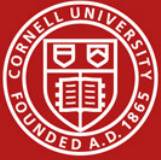

Linear Optics (C – short pulse)



CHESS & LEPP

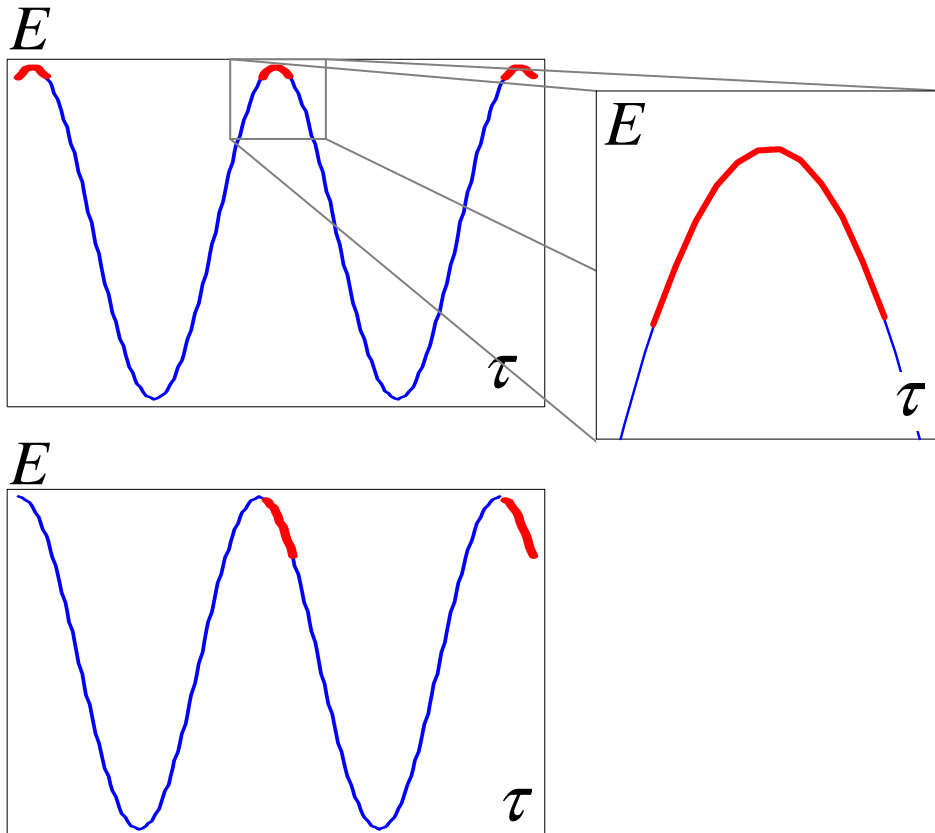

- On crest acceleration leads to long Bunches with small energy spread.

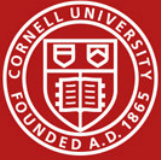

Linear Optics (C – short pulse)



CHESS & LEPP

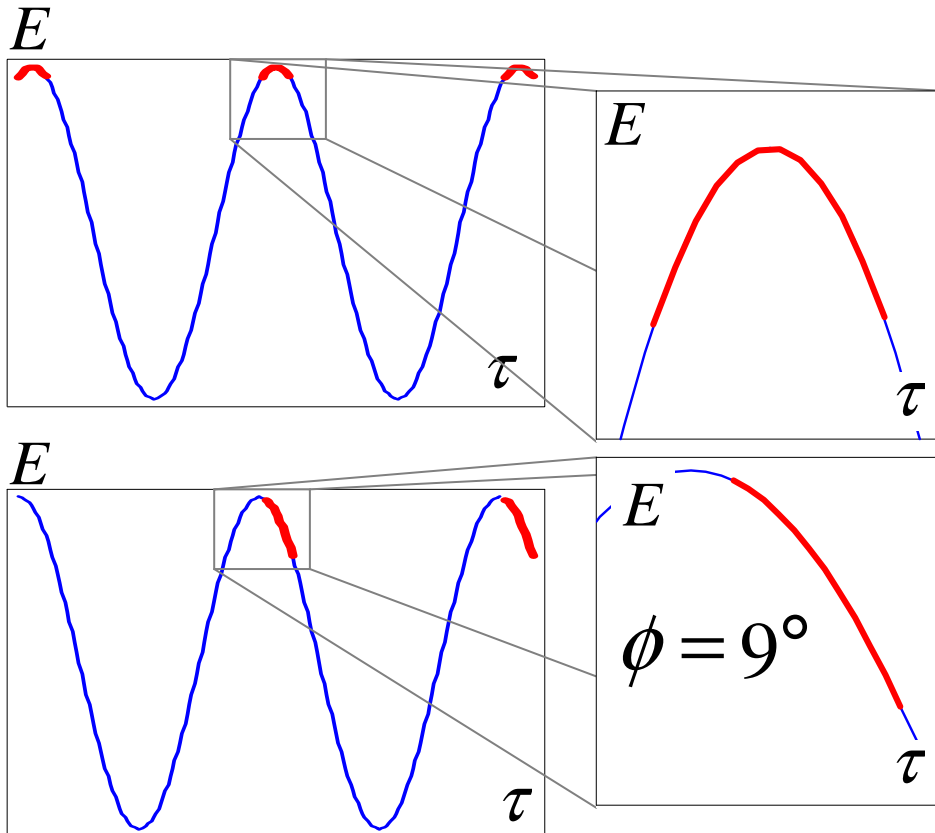

- On crest acceleration leads to long Bunches with small energy spread.
- Off crest acceleration leads to short Bunches with more energy spread.

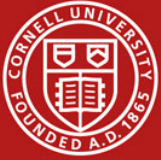

Linear Optics (C – short pulse)



CHESS & LEPP

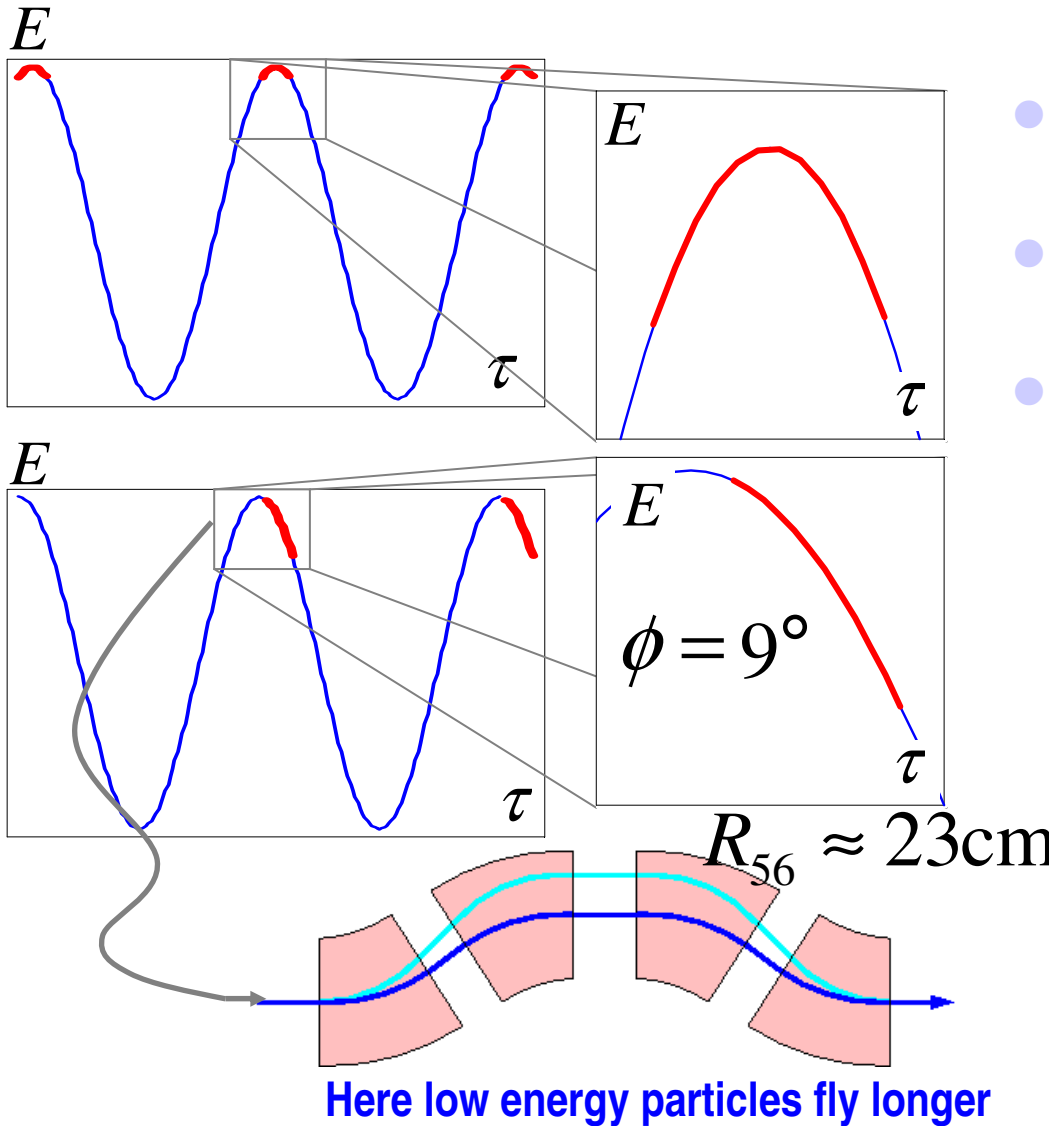

- On crest acceleration leads to long Bunches with small energy spread.
- Off crest acceleration leads to short Bunches with more energy spread.
- The bunch length can be made even shorter by nonlinear optics

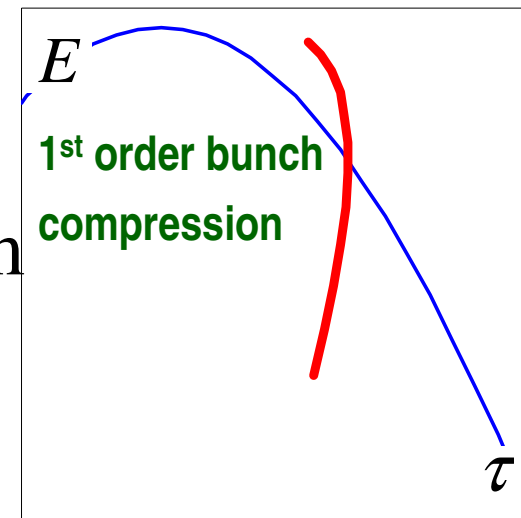



Linear Optics (C – short pulse)



CHESS & LEPP

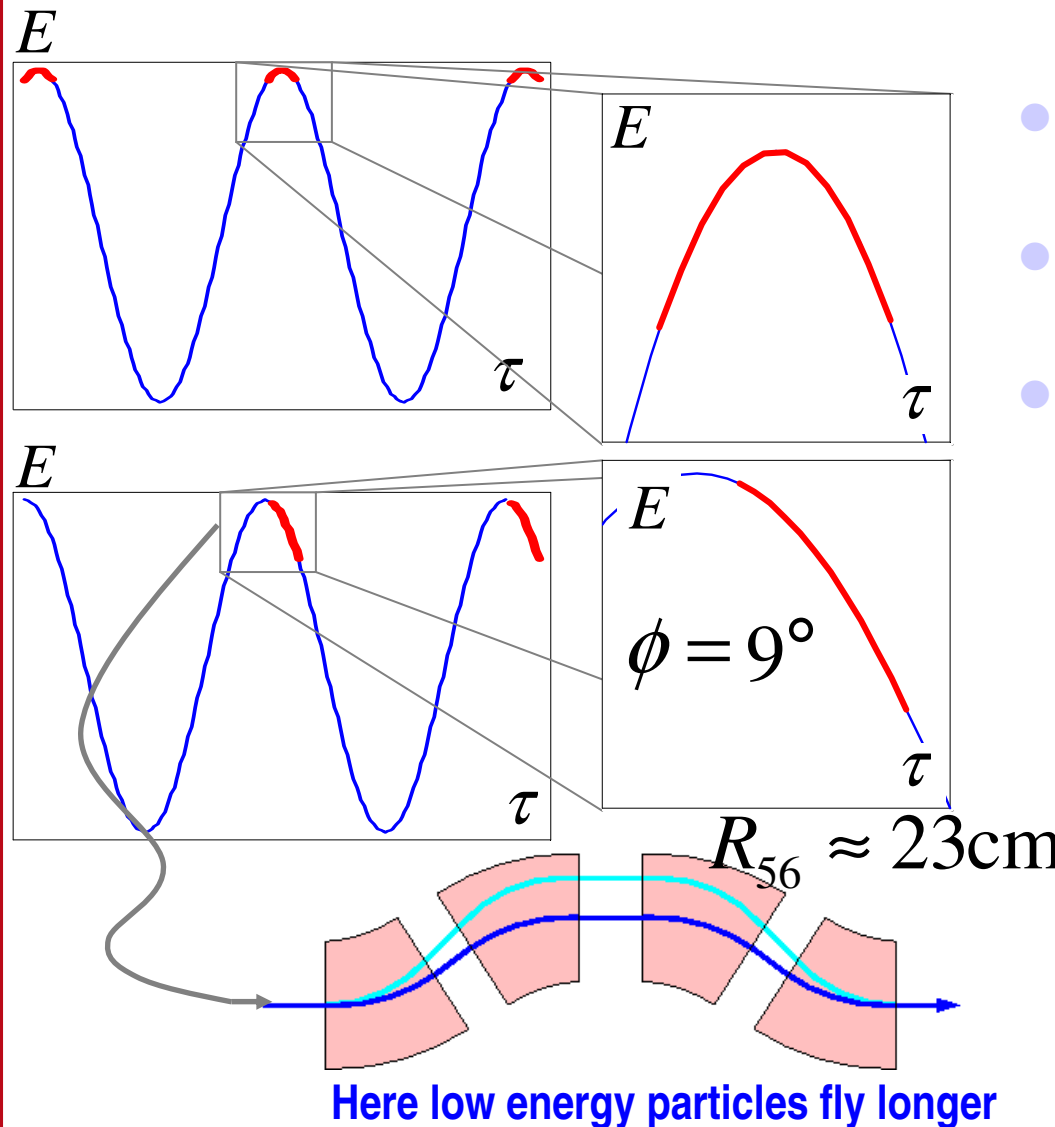

- On crest acceleration leads to long Bunches with small energy spread.
- Off crest acceleration leads to short Bunches with more energy spread.
- The bunch length can be made even shorter by nonlinear optics

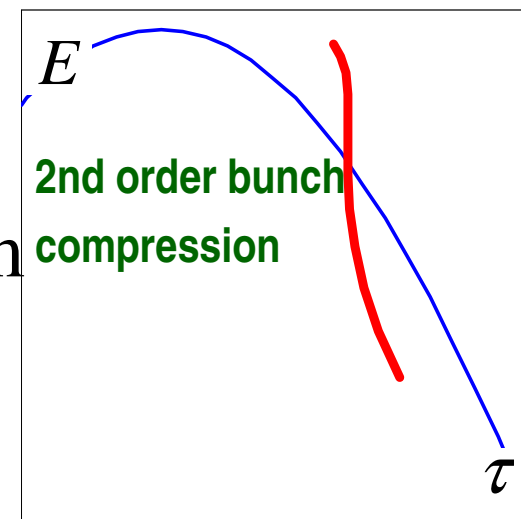



Linear Optics (C – short pulse)



CHESS & LEPP

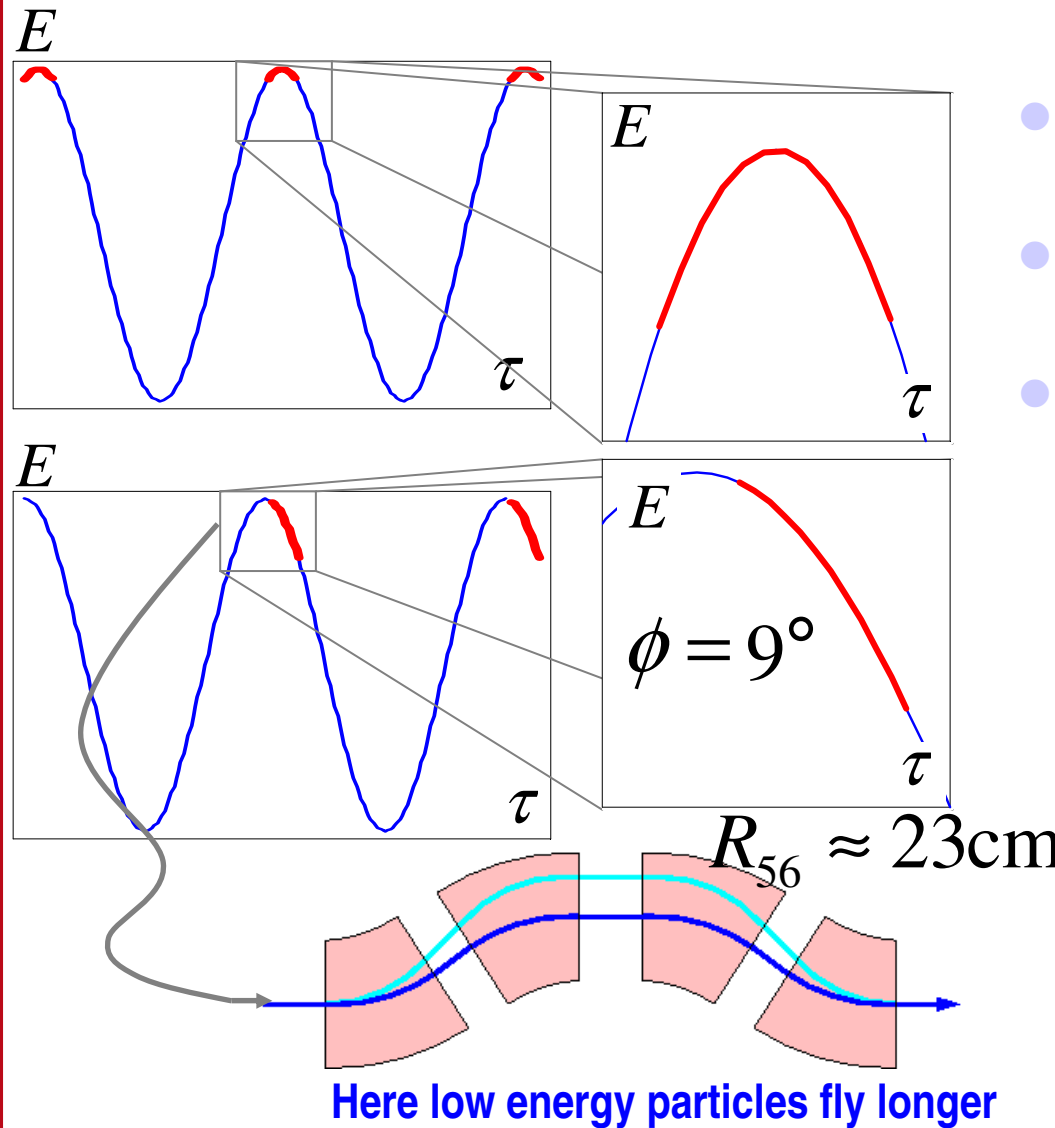

- On crest acceleration leads to long Bunches with small energy spread.
- Off crest acceleration leads to short Bunches with more energy spread.
- The bunch length can be made even shorter by nonlinear optics

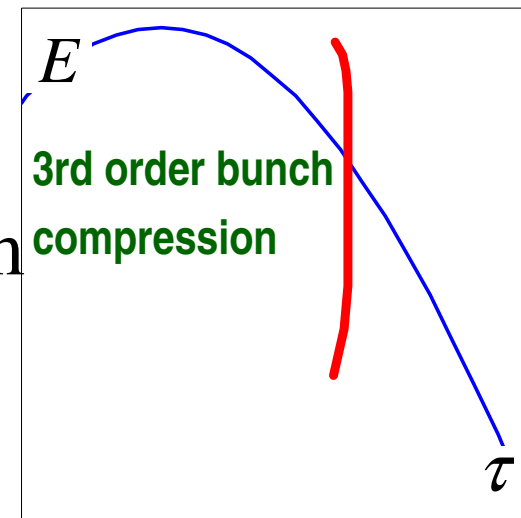



Incoherent Synchrotron Radiation (ISR)



CHESS & LEPP

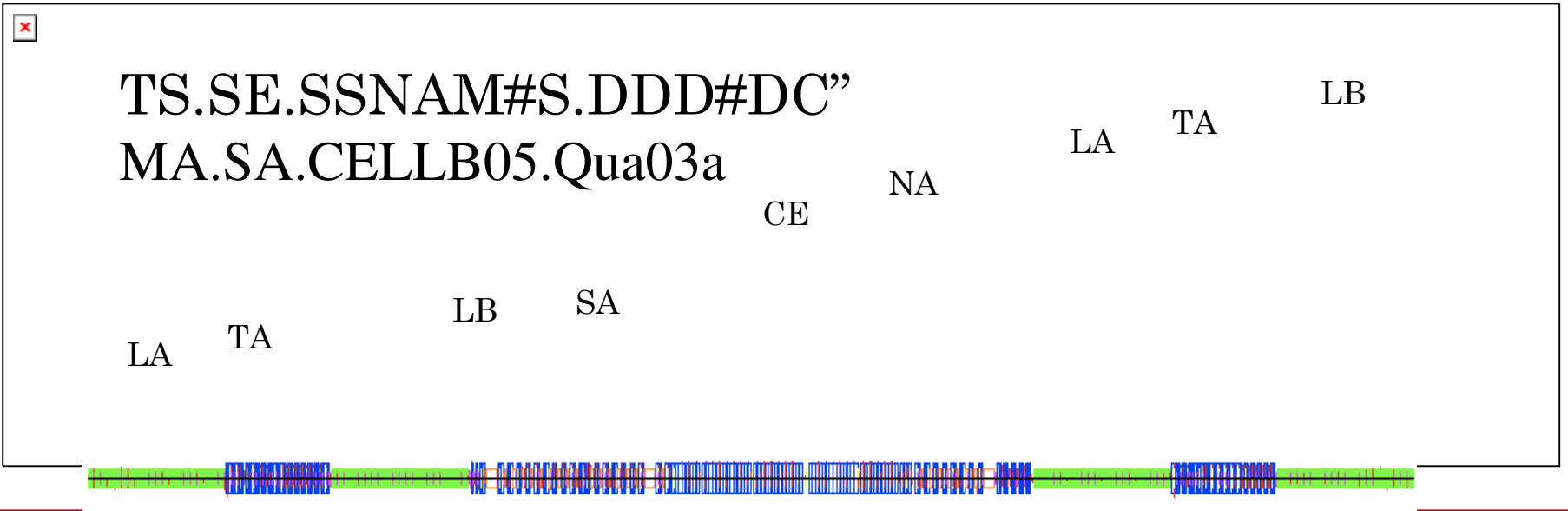
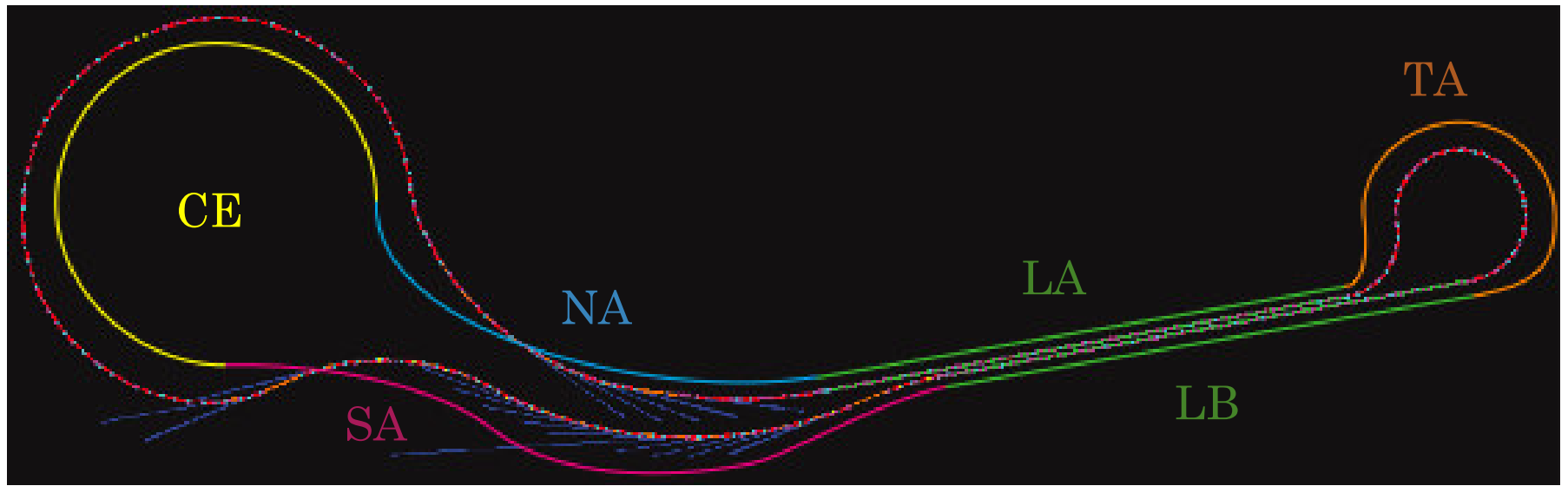

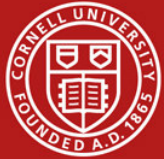

Coherent Synchrotron Radiation



CHES & LEPP

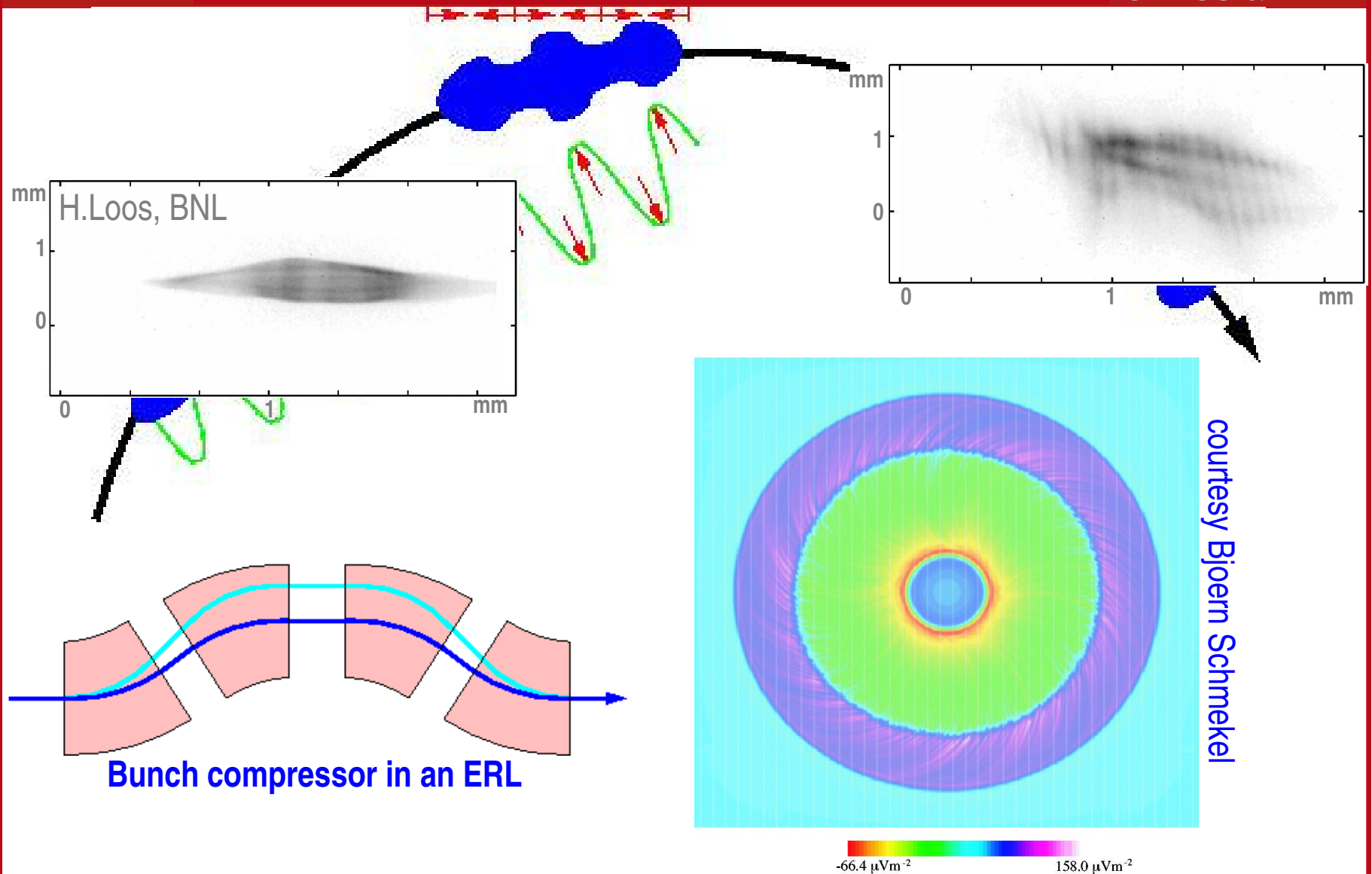

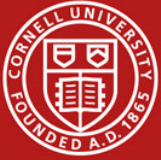

Microbunching due to CSR



CHESS & LEPP

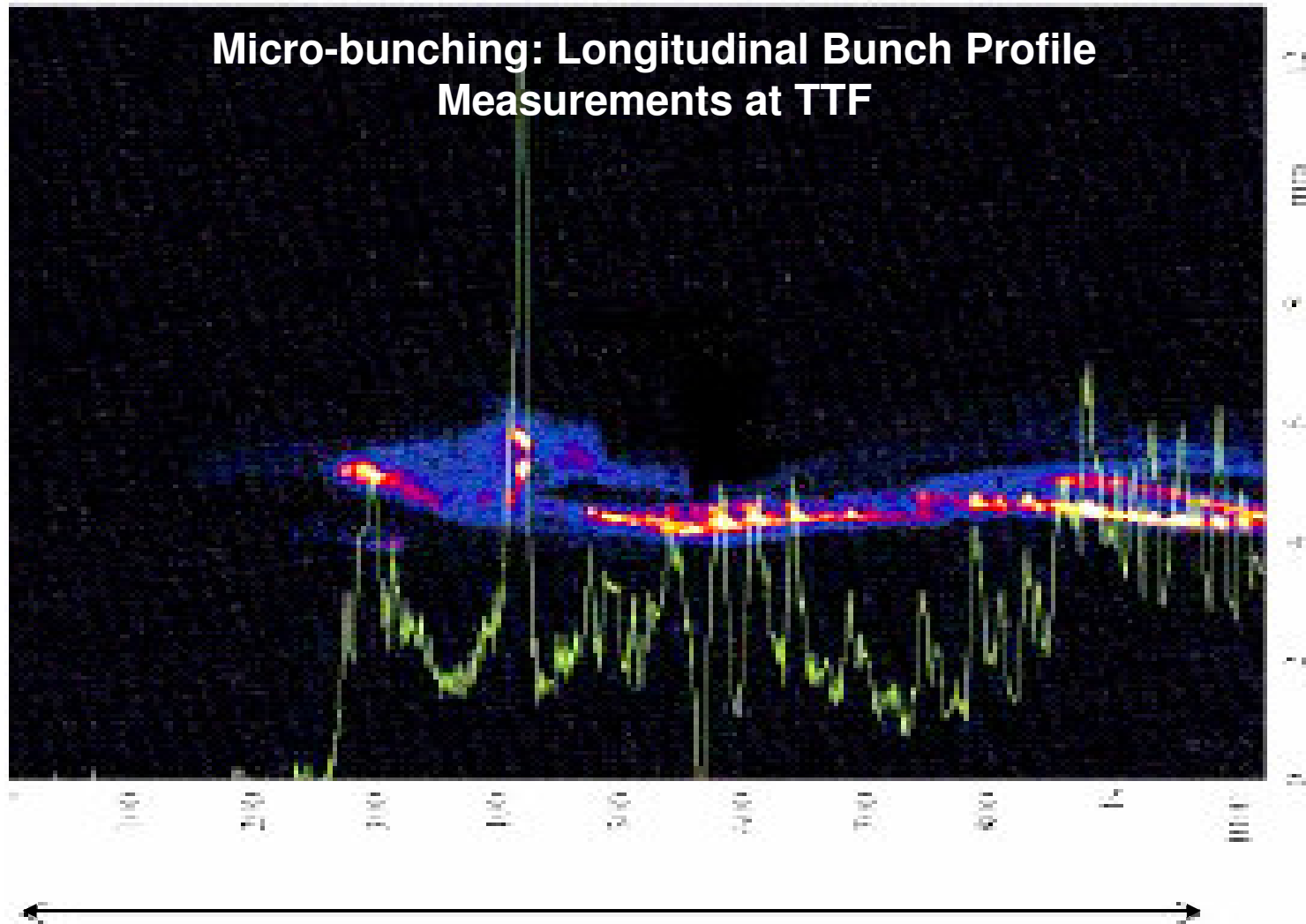

1 picosecond



Coupler kicks



CHESS & LEPP

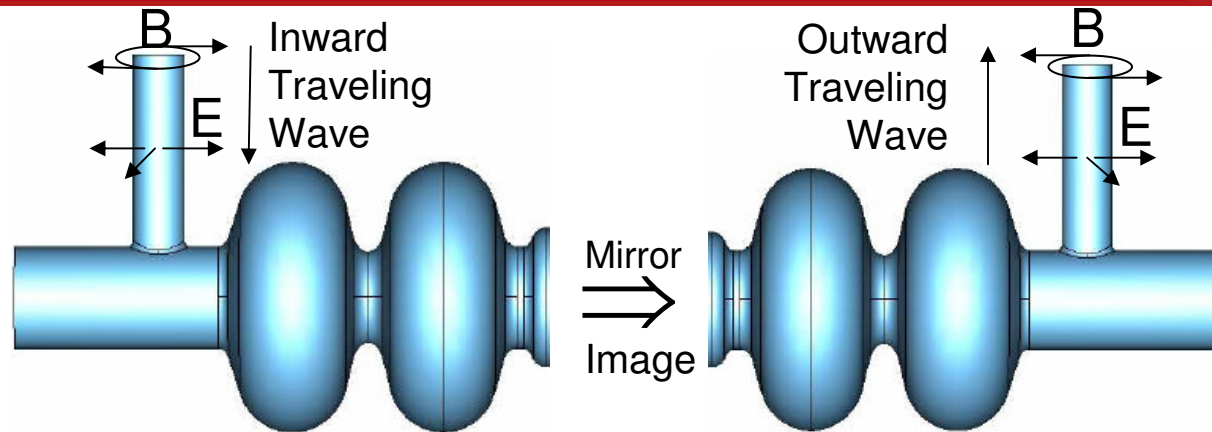

Q_{ext}	Position of Coupler	coupler_strength	coupler_phase (rad/ 2π)
2×10^7	entrance	1.0002857×10^{-4}	.32307
2×10^7	exit	1.0022857×10^{-4}	-.31351
1×10^8	entrance	1.00857×10^{-4}	.321436
1×10^8	exit	1.0277143×10^{-4}	-.31922

Emittance growth	Phase not minimized		Phase minimized	
	$Q_{ext} = 2 \times 10^7$	$Q_{ext} = 1 \times 10^8$	$Q_{ext} = 2 \times 10^7$	$Q_{ext} = 1 \times 10^8$
No Couplers	0.9%	0.9%	0.9%	0.9%
Onesided	1.39%	1.40%	0.97%	0.95%
Alternating Cavities	43.07%	43.92%	0.95%	0.93%
Alternating Cryomodules	1.13%	1.13%	0.96%	0.95%



Cavity control for SC linacs (ERL & ILC)



CHESS & LEPP

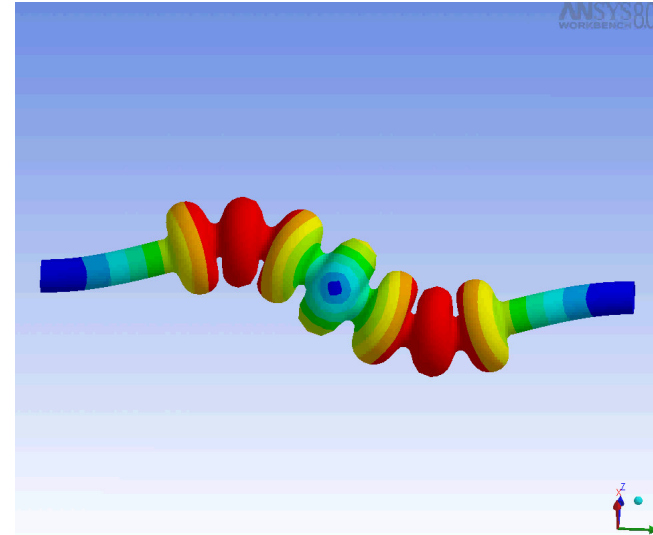
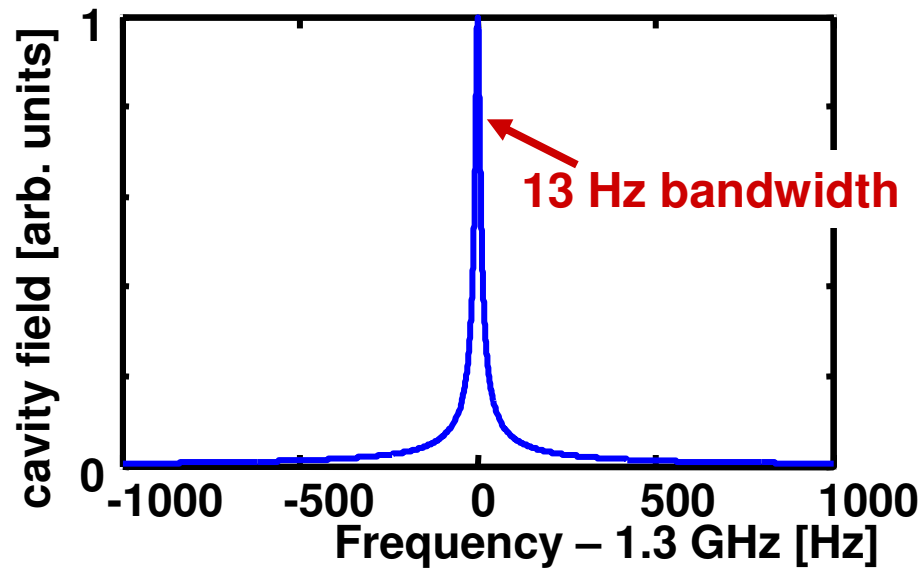

- Run cavity with lowest possible bandwidth for ERL.
- But frequency stabilization becomes very critical.

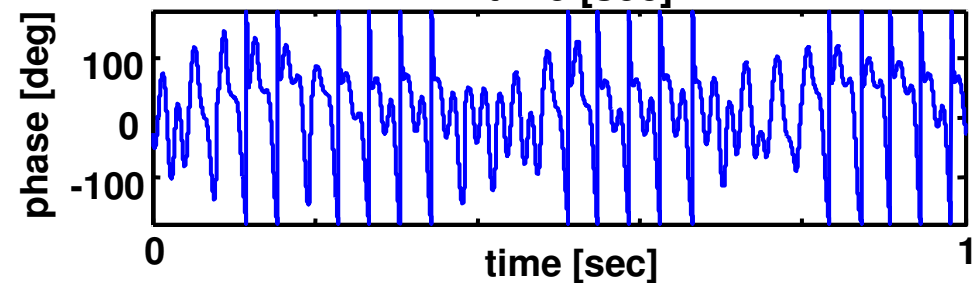
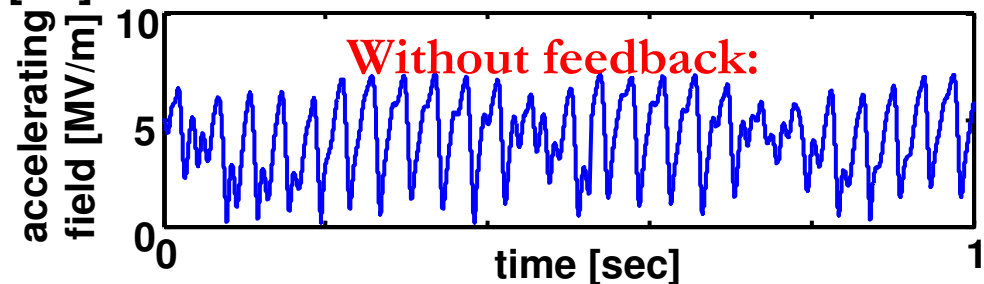



Cavity control for SC linacs (ERL & ILC)



CHESS & LEPP

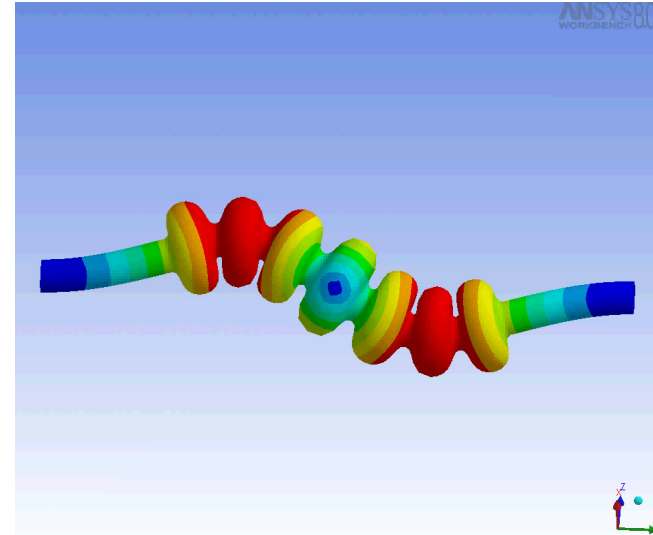
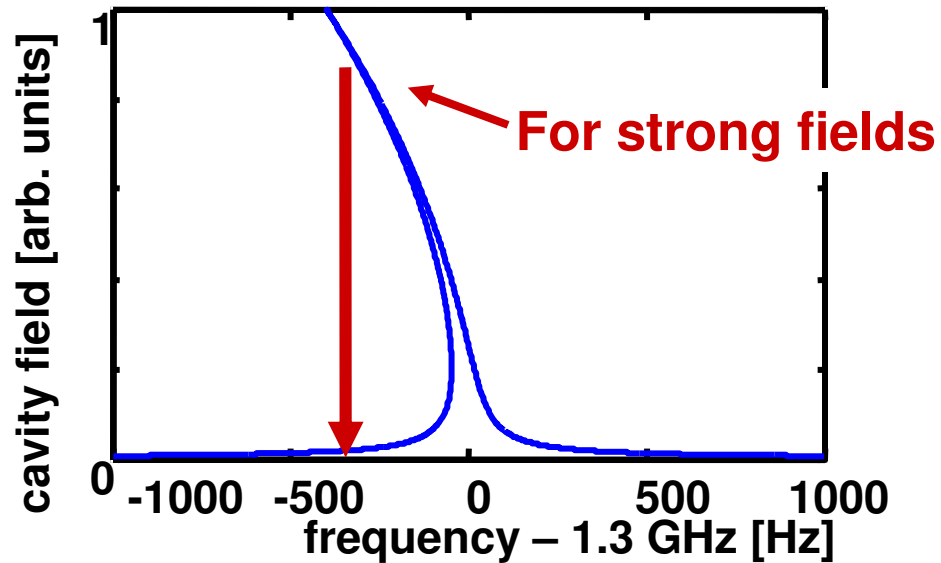

- Run cavity with lowest possible bandwidth for ERL.
- But frequency stabilization becomes very critical.

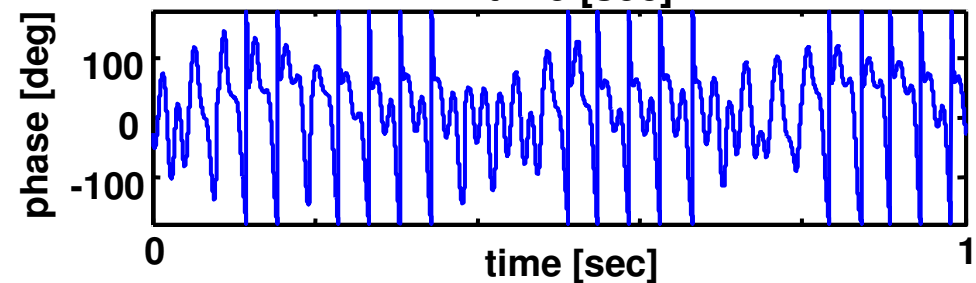
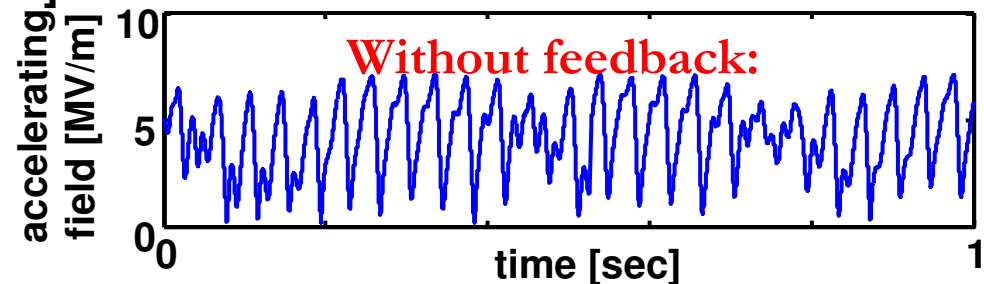

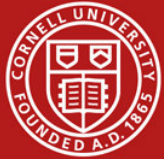

Cavity control for SC linacs (ERL & ILC)



CHESS & LEPP

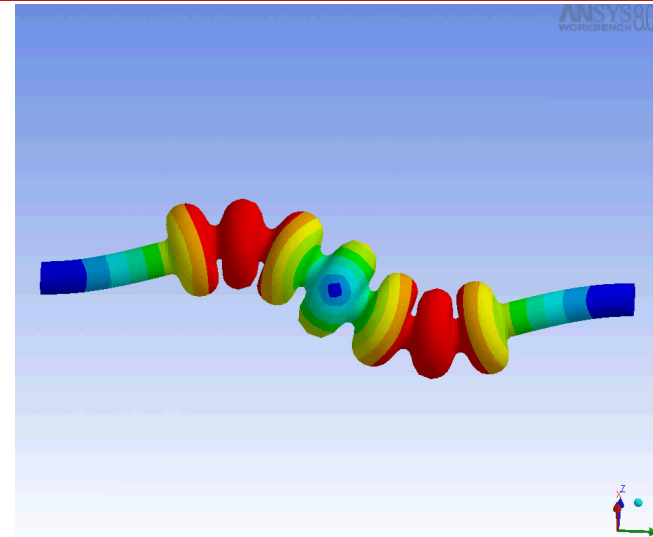
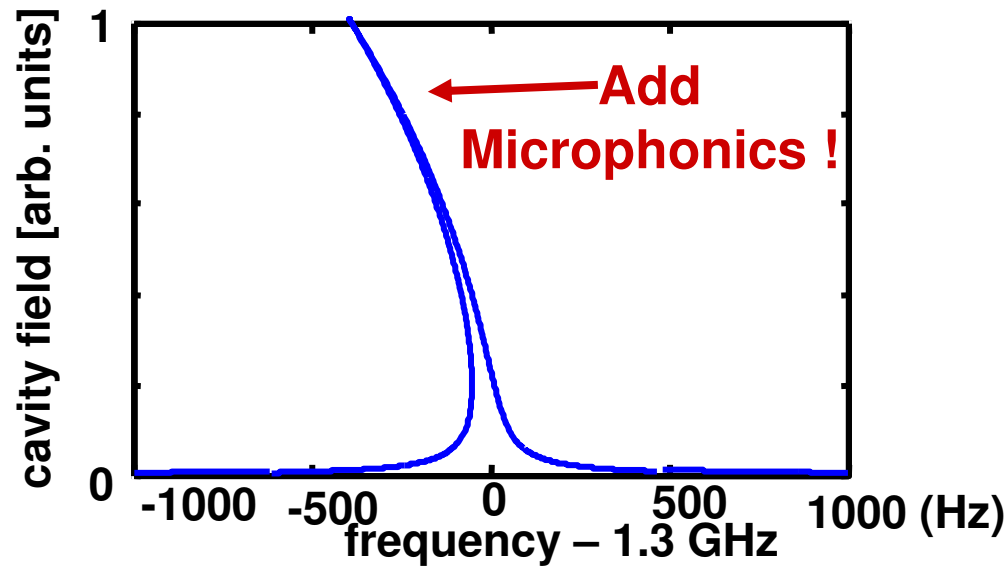

- Run cavity with lowest possible bandwidth for ERL.
- But frequency stabilization becomes very critical.

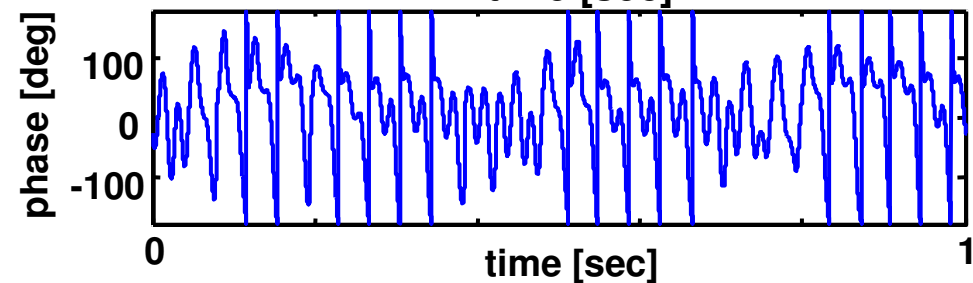
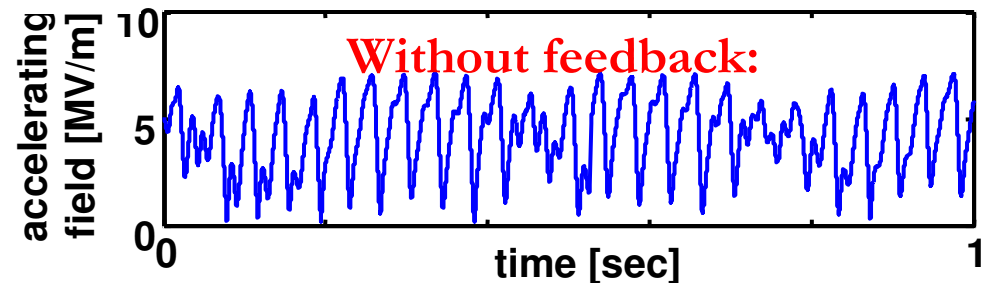



Cavity control for SC linacs (ERL & ILC)



CHESS & LEPP

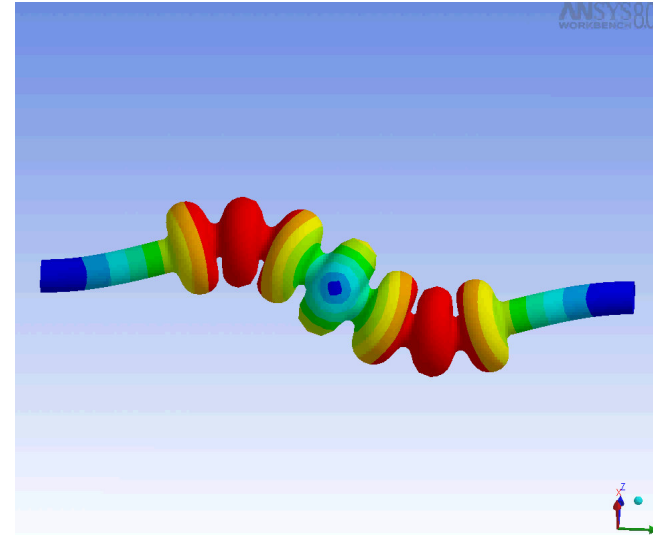
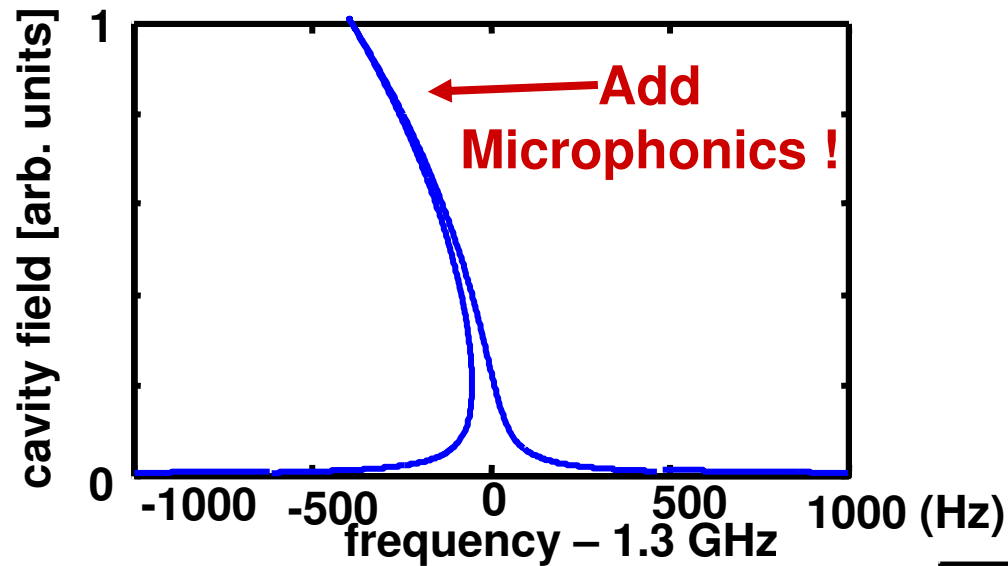

- Run cavity with lowest possible bandwidth for ERL.
- But frequency stabilization becomes very critical.

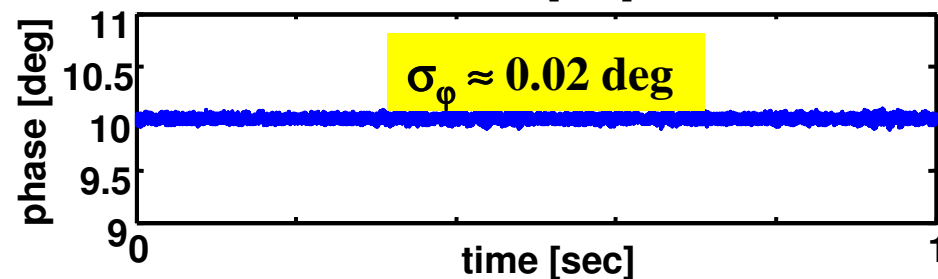
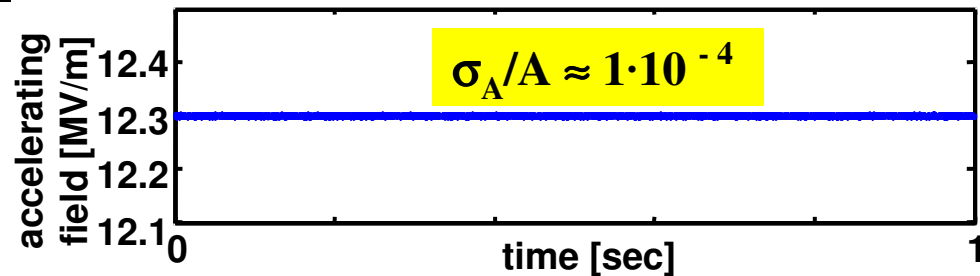

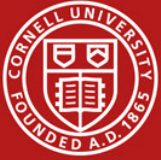

BBU: Collective Instabilities



CHESS & LEPP

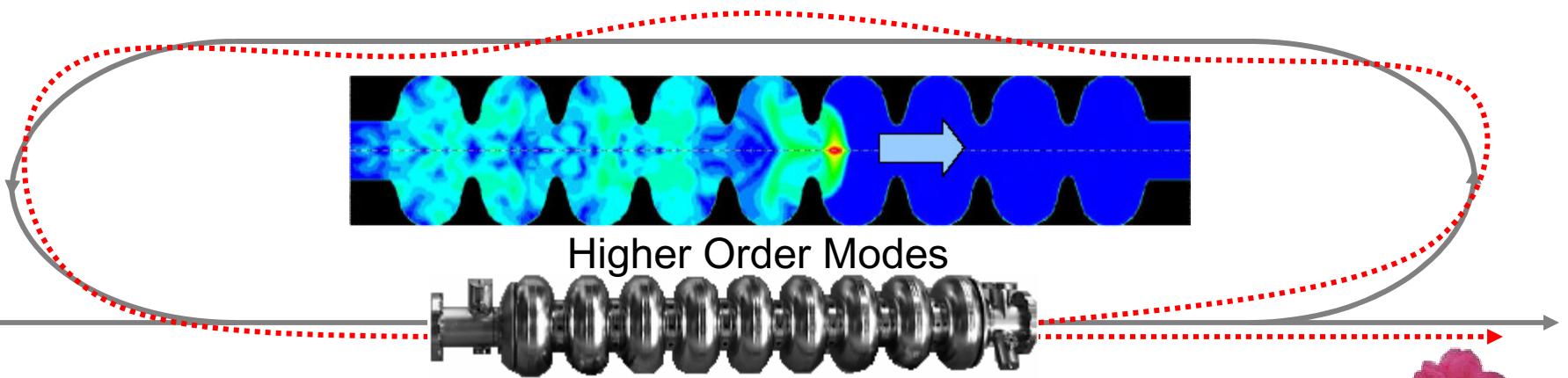

$$V_x(t) = T_{12} \frac{e}{c} \int_{-\infty}^t W_x(t-t') V_x(t'-t_r) I(t') dt'$$

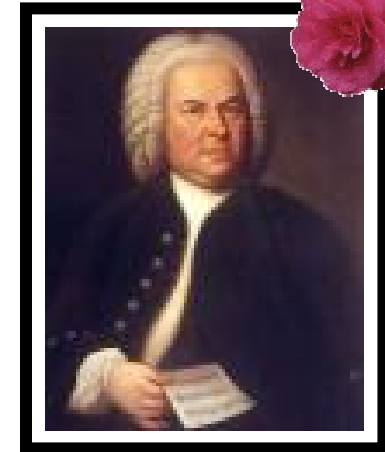

- Similar instabilities would occur in the Linear Collider



HOM absorbers a la Cornell



CHESS & LEPP

From design

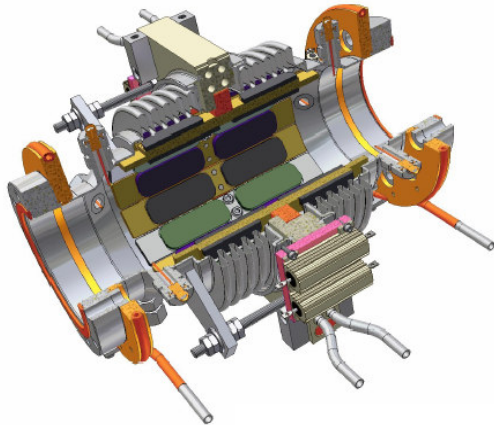

to production and



The Cornell-type HOM absorbers:

- first developed for CESR
- adopted internationally
- Refined for the ERL

HOM absorbers quickly reduce unwanted field components.

Installation, made in Cornell

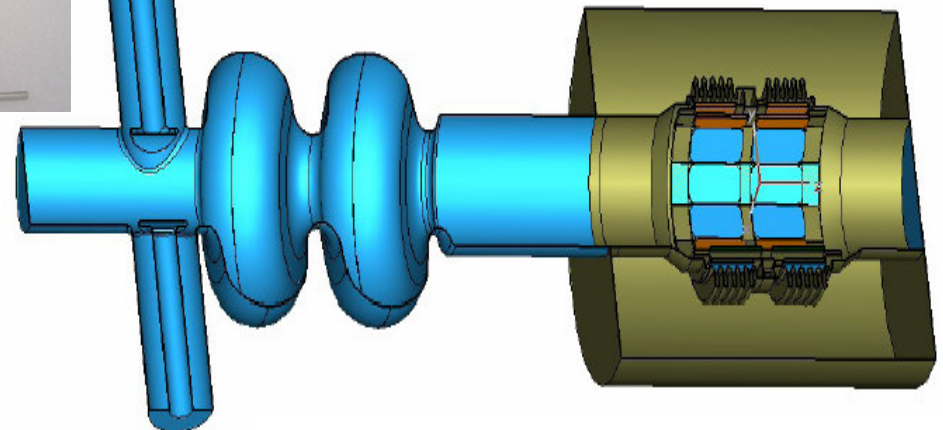



ERL student projects



CHESS & LEPP

The ERL is a great chance for students to make real contributions:

- Accelerator layout and optimization (PhD student Chris Mayes)
- Beam stability and stabilization (PhD student Changsheng Song)
- Design of ion absorbers (PhD student Yi Xie)
- Beam disturbance by ions (HEP-PhD student Christian Spethmann)
- Couple kick beam dilution (Cornell undergrad Brandon Buckley)
- Characterization of optimal gun materials (Cornell undergrad Vaibav)
- Several other Cornell undergrads and REU students for injector controls, dump design, beam simulations, cavity design, ...

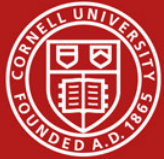

Non Light Source ERLs



CHES & LEPP

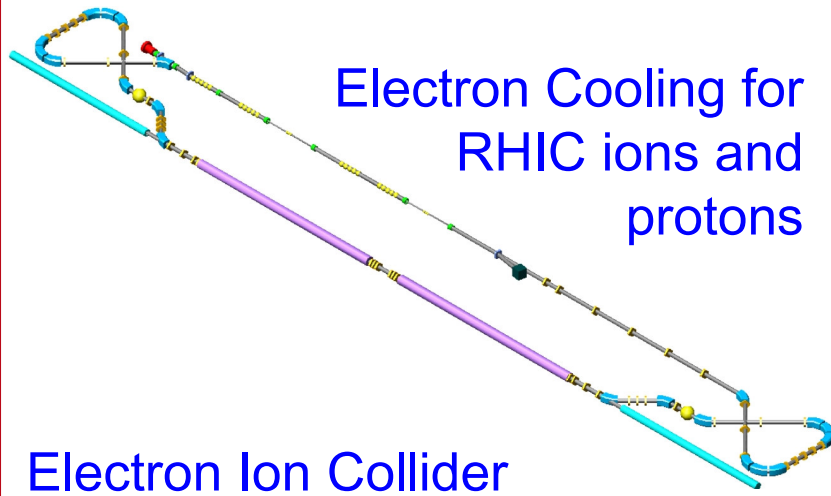

Electron Ion Collider

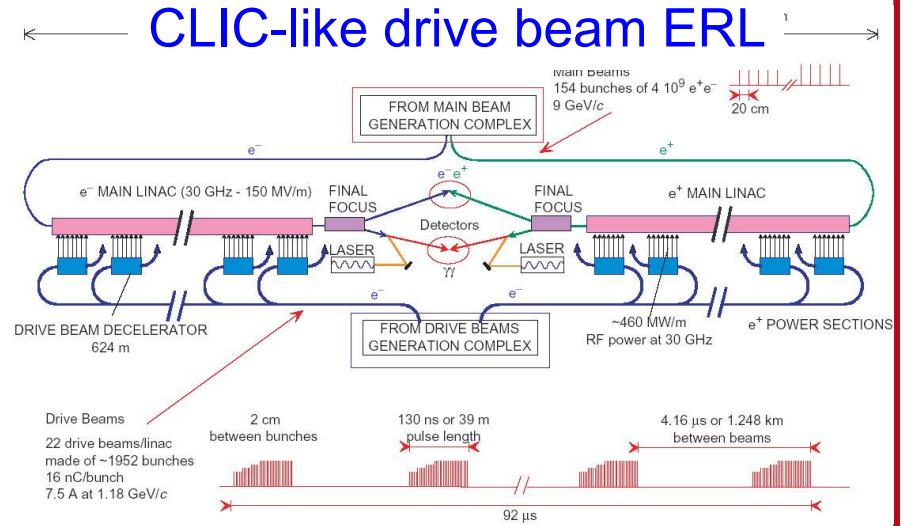
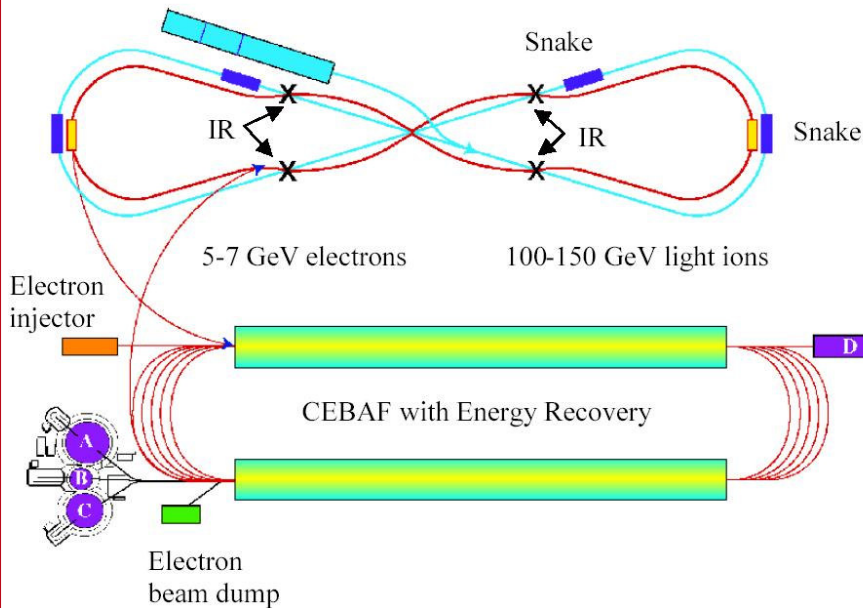

**A low emittance RF source
Could save the electron
damping ring in a LC**



The International Linear Collider (ILC)



CHESS & LEPP

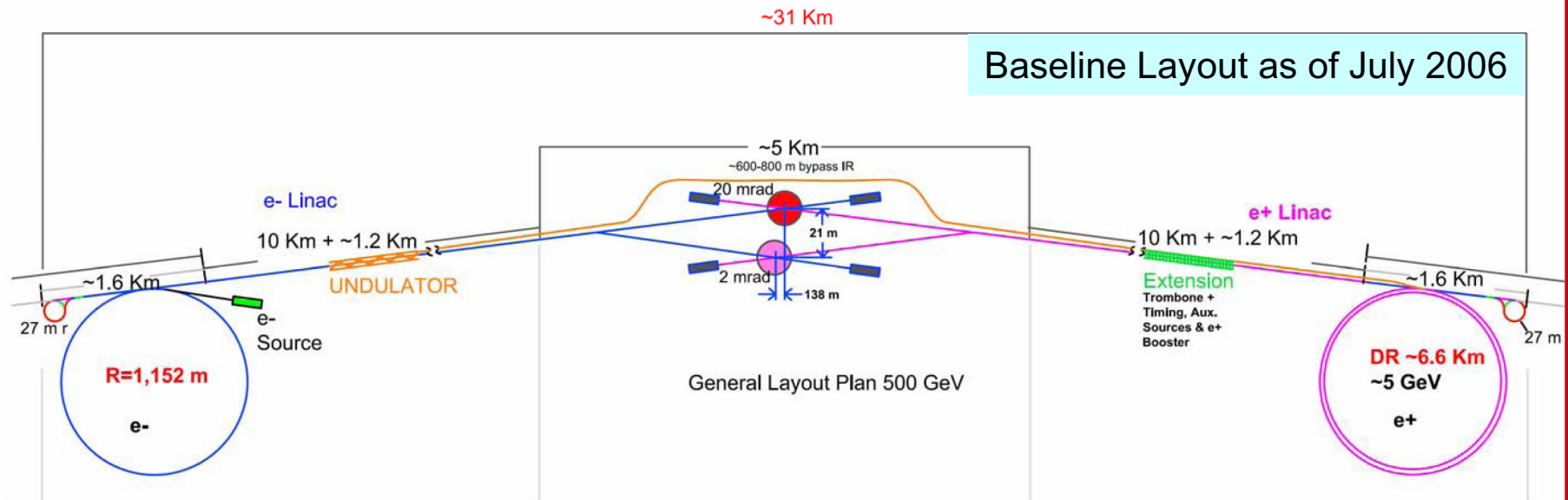

- **Key Milestones**
 - Costed Reference Design by the end of 2006
 - Technical Design by the end of 2009
- **An R&D Program To...**
 - Demonstrate the baseline design
 - Optimize cost and performance
 - Develop improvements to the baseline
- **Ready in 2010 to propose construction**

See opening VLCW06 talk by B. Barish
<http://vlcw06.triumf.ca/>



- **Ring to Final Focus - Low Emittance Transport and BBA**
- **Helical Undulator for the Positron Source**
- **Superconducting RF**
 - Facilities: BCP, EP, HPR, Cavity Test
 - Re-entrant cavity development
 - Basic R&D on Niobium Cavities
 - 650 MHz RF for Damping Rings
- **Damping Rings**
 - Simulation
 - Kickers
 - Wigmblers
 - Instrumentation
 - CesrTF

Simulation Tools Based On BMAD

D. Sagan

<http://www.lepp.cornell.edu/~dcs/bmad>



ILC main linac 9-cell SRF cavities



CHESS & LEPP



Assembly
Complete



Vertical
Test



Research Subjects with Solid State Physics aspects:

- Higher gradients in solid niobium cavities (**ILC and ERL**)
- Understand the dependence on Q on field (**ILC and ERL**)
- Alternate materials for superconducting cavities, e.g. Nb₃Sn, Nb bonded to Cu, Nb on Cu, ... (**ILC, ERL, Muon accelerator**)
- Improve breakdown characteristics of cavities to assure high duty factor operation (**main ERL and ILC**)

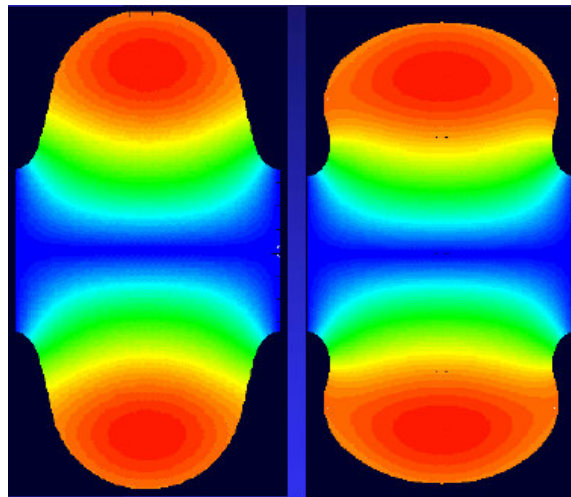
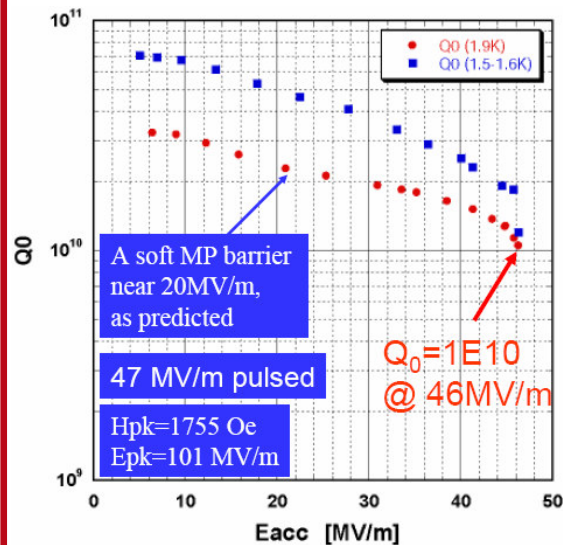

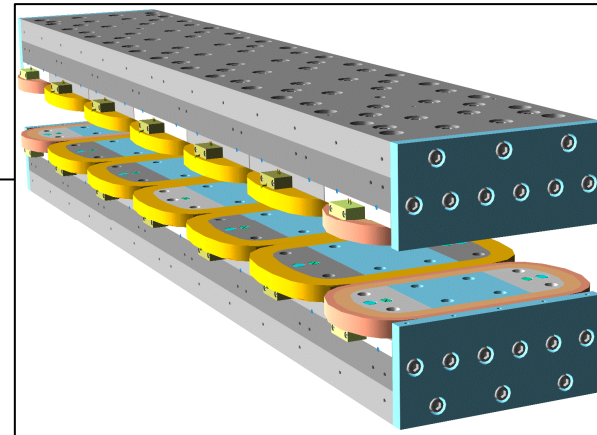

- **Primary Goals**

- **Electron cloud measurements**

- e^- cloud buildup in wigglers
- e^- cloud mitigation in wigglers
- Instability thresholds
- Validate the ILC DR wiggler and vacuum chamber design (critical for the single 6 km positron ring option)

- **Ultra-low emittance operations and beam dynamics**

- Study emittance diluting effect of the e^- cloud on the e^+ beam
- Detailed comparisons between electrons and positrons
- Also look at fast-ion instability issues for electrons
- Study alignment issues and emittance tuning methods
- Emittance measurement techniques

- **ILC DR hardware development and testing**

- ILC DR wiggler prototype, wiggler vacuum chamber, 650 MHz SRF, kickers, alignment & survey techniques, instrumentation, *etc.*



CESR Modifications



- **Move 6 wigglers from the CESR arcs to the North IR (zero dispersion region)**
 - New cryogenic transfer line required
 - Zero dispersion regions can be created locally around the wigglers left in the arcs
- **Make South IR available for insertion devices and instrumentation**
- **Instrumentation and feedback upgrades**

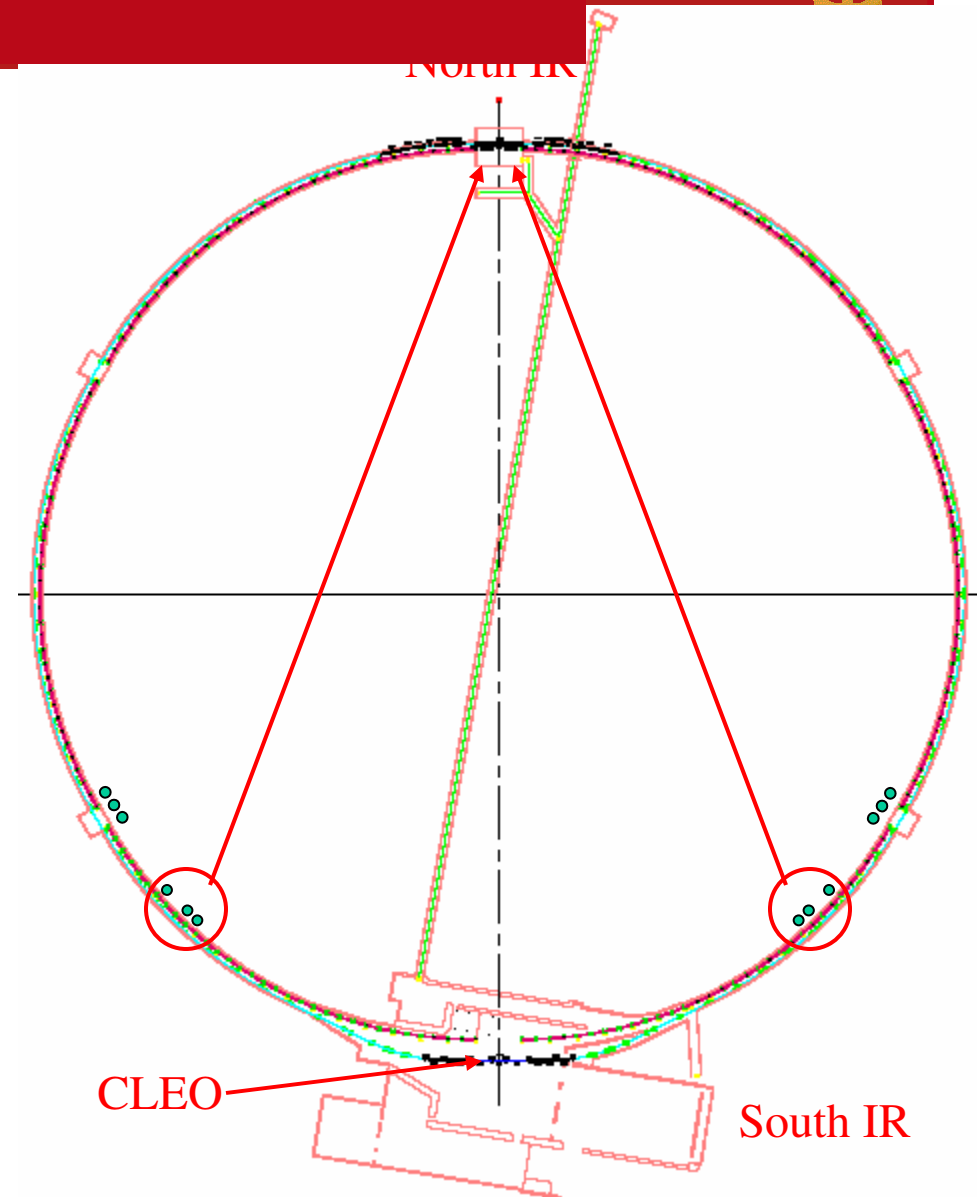
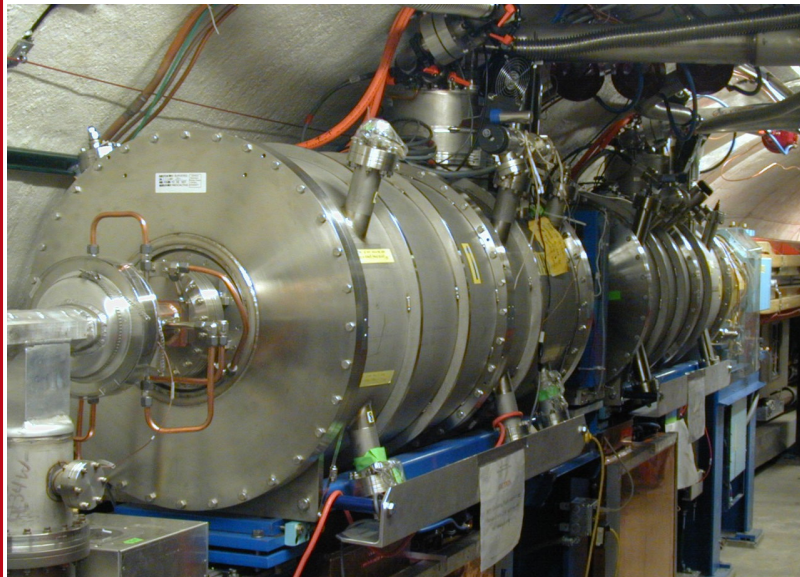

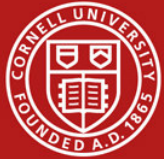

Linear Collider @ Cornell



CHESS & LEPP

Subjects esp. suitable for Cornell:

- Low emittance electron sources (as **ERL**)
- Undulator based positron sources (from **CESR undulator** expert)
- Damping rings (have wigglers like **CESR**)
- Beam dynamics simulation and accelerator modeling (based on codes for **CESR and ERL**)
- Bunch compressors (similar to **ERL**)
- Many superconducting RF subjects (as **ERL**)
- Crab cavities for the collision region (as in **LHC**)

