

# ERL upgrade of an existing X-ray facility: CHESSE at CESR\*

G.H. Hoffstaetter†

## Abstract

Cornell University has proposed an Energy-Recovery Linac (ERL) based synchrotron-light facility which uses 5 GeV, 100 mA electron beams to provide greatly improved X-ray beams due to the high electron-beam quality that is available from a linac. A short bunch mode with a bunch duration of 100 fs is also planned. Particle optical aspects of this design are described here.

## THE CORNELL X-RAY ERL PROJECT

Cornell University has proposed an Energy-Recovery Linac (ERL) based synchrotron-light facility which can provide greatly improved X-ray beams due to the high electron-beam quality that is available from a linac. To provide beam currents competitive with ring-based light sources, the linac must operate with energy recovery, the feasibility of which we plan to demonstrate in a downscaled prototype ERL. Here we present two of several 5 GeV ERL upgrade possibilities for the existing 2nd generation light source CHESSE at CESR. This proposed upgrade suggests how existing storage rings can be extended to ERL light sources with much improved beam qualities.

Since today's ring-based light sources have beam energies of several GeV and beam currents a sizable fraction of an Ampere, Cornell is planning a facility that can deliver 5 GeV beams of 100 mA. Continuous beams of these currents and energies would require klystrons delivering a power of the order of a GW to the beam. Without recovering this energy after the beam has been used, such a linac is impractical.

DC photo-emission sources with negative electron affinity cathodes have been simulated to give less than  $0.4\pi$  mm mrad for a 100 mA beam current in a continuous beam at 1.3 GHz. [1]. However, the large beam powers and small transverse and longitudinal emittances required for an X-ray ERL have not been achieved anywhere. CESR has been used for the high-energy physics experiment CLEO and as the 5 GeV second generation light source CHESSE since its construction and it will be available for X-ray physics alone when CESR stops high energy physics operation. Then we plan to upgrade CHESSE to an ERL facility based on the CESR complex.

Cornell University is currently prototyping a DC photo-emission electron source and a 10 MeV injector linac [2] for low emittance beams of high CW currents [3]. The bunches that this injector is designed to produce [4] could be accelerated in the planned X-ray ERL.

Current (mA)	100	10	1
Charge/b (nC)	0.08	0.008	1.0
$\epsilon_{x/y}$ (nm)	0.1	0.015	1
Energy (GeV)	5.3	5.3	5.3
Rep. rate (GHz)	1.3	1.3	0.001
Av. flux ( $\frac{\text{ph}}{0.1\% \text{ s}}$ )	$9 \cdot 10^{15}$	$9 \cdot 10^{14}$	$9 \cdot 10^{12}$
Av. brilliance ( $\frac{\text{ph}}{0.1\% \text{ s mm}^2 \text{ mrad}^2}$ )	$1.6 \cdot 10^{22}$	$3.0 \cdot 10^{22}$	$2.0 \cdot 10^{17}$
Bunch length (ps)	2	2	0.1

Table 1: Parameters for an ERL at Cornell University for three different running modes: for high flux, for high coherence, and for short pulses. We show initial target emittance figures, simulations suggest that lower values may be possible.

An X-ray ERL will enlarge the wide range of applications of third generation light sources by producing beams similar to their CW beams, albeit with much higher brilliance due to the much smaller horizontal emittance and possibly smaller energy spread. At the same time, it can serve more specialized experiments that require ultra small emittances for high spacial resolution or ultra short bunches for high temporal resolution [5]. Three different operation modes are planned, one for high flux, one for high brilliance, and one for short bunches. Parameters for these operating modes, not containing the smallest simulated emittances, are shown in Tab. 1.

The design of the Cornell X-ray ERL should be made cost efficient by reusing much of CESR's infrastructure. The operation of CHESSE should be disrupted as little as possible while building and commissioning the ERL, the facility should provide space for a sufficient number of X-ray beamlines. While it could have turned out that reusing CESR imposes too many constraints, quite contrary it has been found that the flexibility of CESR's magnet arrangement holds several advantages for an ERL design. First and second order electron optics have been found for bunch compression down to at least 100 fs, and nearly all required magnet strength could be supported by the magnets that are in CESR today. In order to extend the space for cavities, to make space for possible upgrades, and to minimize the impact on CHESSE operation, work has been invested in the layout of Fig. 1. It shows the CESR tunnel and the layout of a possible linear ERL extension. Electrons from a 10 MeV injector (1) would be accelerated to the right in a 2.5 GeV linac (2). A return loop (3) would send them into a second linac which is located in the same straight tunnel (4) and accelerates to 5 GeV. An arc (5) injects the electrons into the CESR ring (6) where they travel counterclockwise

\* Contribution to the ERL Workshop, TJNAF, 2005

† Georg.Hoffstaetter@cornell.edu

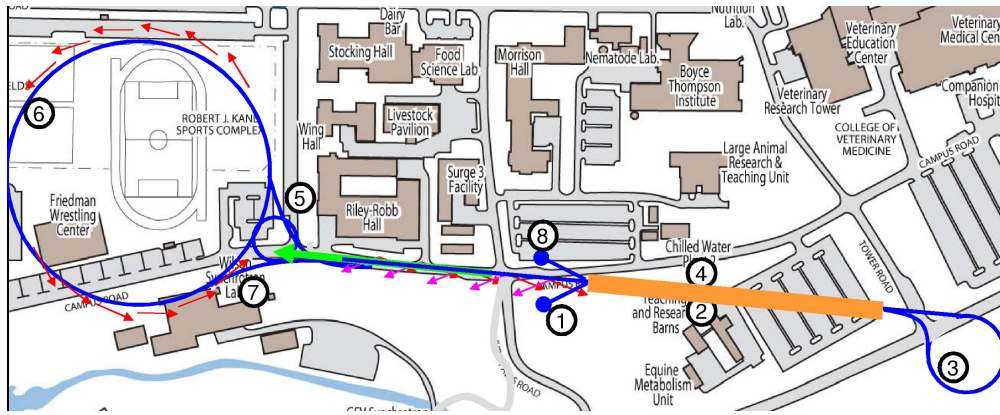

Figure 1: An ERL in an extended CESR tunnel.

until another arc (7) injects them back into the first linac, where they are decelerated to 2.5 GeV. The return loop leads the electrons to the second linac section where deceleration back to 10 MeV and leads to the beam dump (8). The South half of the CESR tunnel would contain undulators and would reuse the current facilities of CHESR. Additionally, new user areas could be created in the North section of CESR (at the top of the figure) and in straight sections of the linac tunnel. The location of the linac at a hillside is chosen in such a way that no existing building foundations interfere and that X-ray beamlines with easy access can be added between the linac and CESR.

A return arc is also shown which connects the arcs (5) and (7) so that electrons can return to the linacs after acceleration without passing through CESR. This connection has been chosen so that the ERL could be built and commissioned while CESR is still used as a storage ring light source. Other advantages of this upgrade plan are that all of the CESR tunnel is reused, which creates space for a large number of insertion devices.

To limit the cost of cooling, the accelerating gradient of the SC cavities should not exceed 20 MV/m. Thus, 250 m of cavities would lead to 5 GeV beam energy. However, much more space is required for the linac, since higher order mode (HOM) dampers and connecting tubes have to be placed after each cavity and 2 quadrupoles have to be placed after each cryomodule of ten 7-cell cavities. Our analysis, which is based on the 1.3 GHz cavity cell shape of the TESLA design, on four HOM couplers of the TTF type per cavity, and on one ferrite HOM damper of the CESR type per cavity, showed that for a beam tube radius of 39 mm we could not obtain a fill factor larger than 53%. The total linac length would therefore have to be about 500 m. The tunnel extension shown in Fig. 1 has a section of 250 m with two linacs side by side. A sketch of a possible tunnel cross-section is shown in Fig. 2. A straight tunnel housing two linacs, reduces tunnel cost as well as the required length of cryogenic lines and cables. The tunnel is laid out longer than required for the two linacs, so that an extension of the facility by extra undulators or by an FEL is possible.

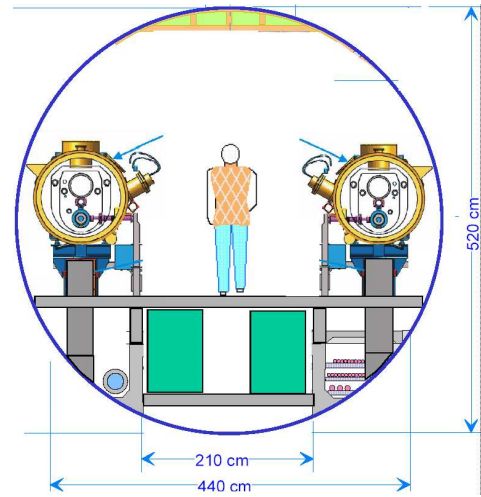

Figure 2: Sketch of a crosssection of a tunnel with two lineacs.

### Arc optics

We studied whether a favorable optics can be found for the CESR South arc in spite of the constraints imposed by the existing tunnel. To reuse as much as possible from CESR, we maintained the bending magnets and quadrupoles in their current positions and only replaced the regions where the undulators would be installed. Each of 7 undulator has two matching quadrupoles at each side and is separated from the next undulator by a three-bend achromate. Finding an optics for the operation with 2ps bunch length turned out to be relatively simple. The matching constraint were:  $\beta = 1\text{m}, 2.5\text{m}, 2.5\text{m}, 12.5\text{m}, 2.5\text{m}, 2.5\text{m}, 1\text{m}$  in the seven successive undulators, and  $\alpha = 0, D = 0, D' = 0$  in these seven places.

The optics for an rms bunch length of 100fs has to fulfill several additional requirements. The RF acceleration phase  $\phi$  and the first and second order time of flight terms  $R_{56}$  and  $T_{566}$  of the first half of the arc have to be chosen to yield the desired bunch length in the central undulator [6]. For the second half of the return arc,  $R_{56}$  and  $T_{566}$  are

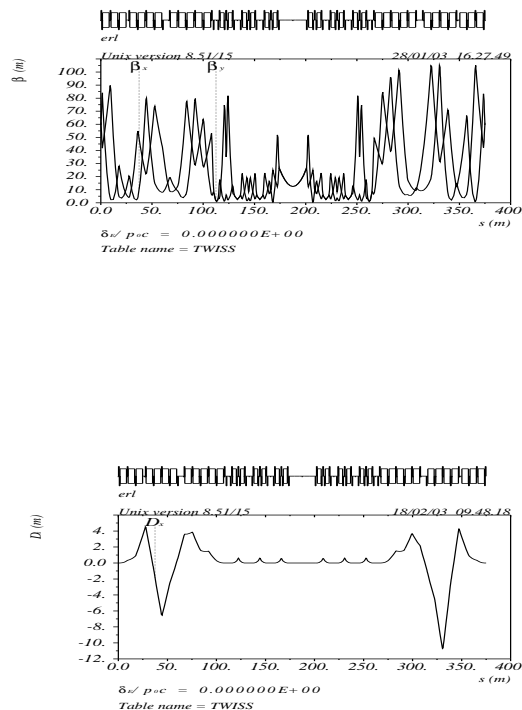

Figure 3: Beta functions and dispersion in the arc

determined by minimizing the energy spread after deceleration. The beta function and the dispersion for the return arc are shown in Fig. 3. Even though the magnet arrangement is symmetric around the center of the arc, the optics functions are not symmetric since the conditions for  $R_{56}$  and  $T_{566}$  are different for the two halves.

The second order time of flight term  $T_{566}$  is influenced by sextupoles and has to have the same sign as  $R_{56}$ . This is hard to achieve in the achromatic arrangements that have been proposed for this purpose. However, with the FODO like optics of the CESR arc this can be achieved with relatively weak sextupoles. This advantage is due to the large dispersion after the linac.

The nonlinear dynamics in sextupoles can increase the emittance. However, due to the weak sextupoles and the small transverse beam size, the dynamics is so weakly nonlinear that only the second order dispersion  $T_{166}$  and its slope  $T_{266}$  had to be eliminated in the center of the return arc. The second order conditions on  $T_{566}$ ,  $T_{166}$  and  $T_{266}$  were satisfied by three sextupoles on each side of the arc close to the three maxima of the dispersion in Fig. 3.

For short-bunch operation, coherent synchrotron radiation (CSR) can also increase the emittance. The emittance growth was computed with the code ELEGANT and is shown in Fig. 4. Since the beam dilution due to the non-

linear dispersion is included, the emittance is shown to decrease where the second order dispersion is corrected. In the central undulator, the emittance for 100fs bunch length has only increased by a factor of 1.8. To limit the emittance growth, it was found prohibitive to compress the bunch length to its minimum since this creates a spike in the longitudinal density and strongly enhances CSR. We therefore increased  $\phi$  to obtain 100fs bunches without full compression.

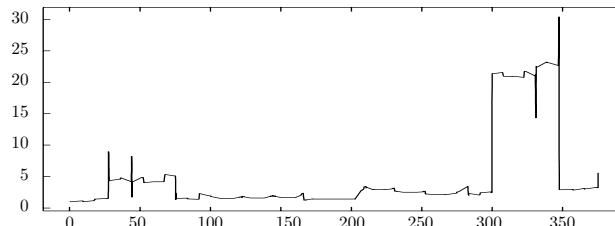

Figure 4: Effective emittance (mm mrad) along the arc

To the 7 undulators in the South section and the 7 in the North section of CESR, additional undulators could be placed in the section between the linac and CESR, which has been designed with a gentle arc of achromats.

### Two linacs and return loop

The loop (3) connecting the two linacs was chosen so as to produce an acceptable emittance increase due to synchrotron radiation. Figure 5 shows an optics with 16 achromatic cells. The magnet in the center of each cell has a negative bend to make the lattice isochronous, it has a horizontally focusing quadrupole which produces a very small average horizontal beta function, and it has a sextupole to correct the second order dispersion. After this correction, nonlinear dynamics does not lead to emittance growth for a 0.2% energy spread beam that one obtains for  $6^\circ$  off-crest acceleration, as required for compressing a 2 ps long bunch to 100 fs after the linac. This loop could also be used for energy spread reduction by running the second linac  $-6^\circ$  off-crest as discussed in [6].

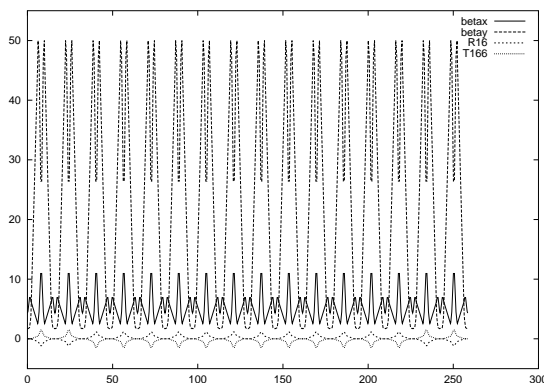

Figure 5: Optics of the return loop.

The emittance growth for a 100mA beam due to incoher-

ent synchrotron radiation for the high flux option in Tab. 1 is 0.04 nm and therefore acceptable. The emittance growth due to coherent synchrotron radiation as computed by EL-EGANT [7] is shown in Fig. 6. The fluctuations are due to second order dispersion, but the difference between the two curves shows the influence of coherent synchrotron radiation. It is approximately 0.006nm and thus negligible.

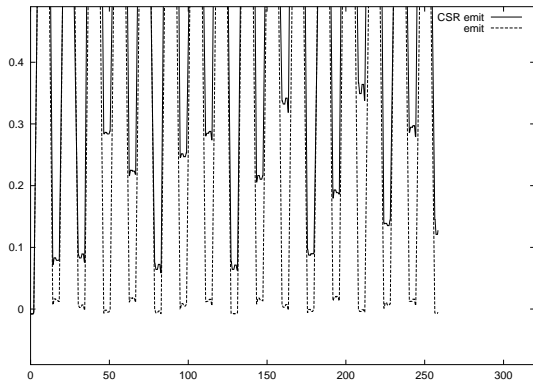

Figure 6: CSR emittance growth in the return loop. Solid: with CSR, dashed: without radiation. Units are % of 0.1nm along the linac (in m).

The optics for the linear accelerator is shown in Fig. 7 in  $x$  and  $y$  for the accelerating beam. Both linacs are shown, but the optics of the return loop is not shown in between them. The optics for the accelerating beam is shown, that for the decelerating beam of the ERL is mirror symmetric. The beta functions are relatively small. The threshold current of the beam breakup (BBU) instability has been calculated for a similar optics [8]. For quite pessimistic assumptions (HOMs with  $R/Q$  of  $100 \Omega$  and  $Q = 10^4$ ) the threshold current is about 200mA for a HOM frequency randomization of 1.3 MHz. When the modes are polarized and an optics is chosen that couples horizontal oscillations to the vertical and vice versa [9], the threshold current is about 650mA.

Emittance growth due to coherent synchrotron radiation is a phenomenon which is hard to compute accurately. We are therefore also investigating alternate designs which minimize the total bend angle of the ERL similar to what was presented in [10]. A possible layout that is adjusted to the geography of the Cornell campus is shown in Fig. 8.

## BEAMLINES

The South half of the CESR tunnel would contain undulators and would reuse the current facilities of CHSS. Additionally, new user areas could be created in the North section of CESR (at the top of Fig. 1) and in straight sections of the linac tunnel. The location of the linac at a hillside is chosen in such a way that no existing building foundations interfere and that X-ray beamlines with easy access can be added between the linac and CESR. The outline and the optics for this section is shown in Figs. 9 and 10.

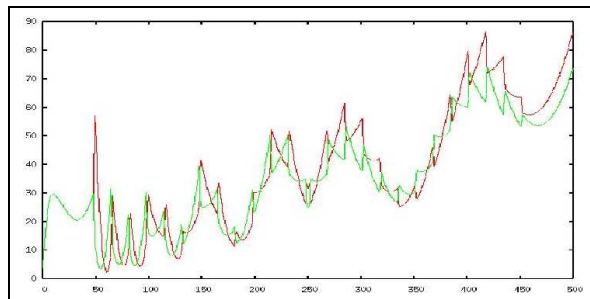

Figure 7: Optics in the two linacs (units are m).

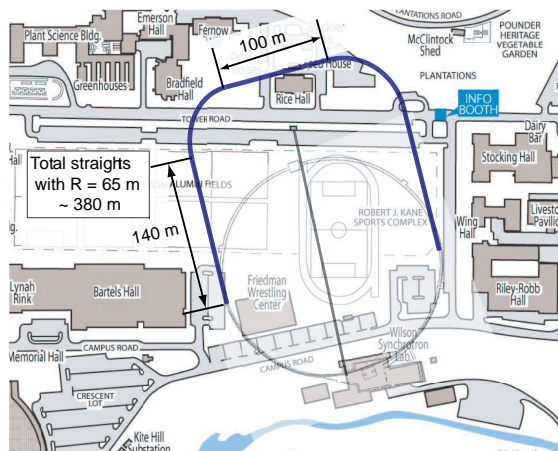

Figure 8: An ERL in the extended CESR tunnel minimizing bend angles.

The presented optics of Fig. 3 modifies CESR as little as possible. It contains four undulators of 5 m length, two undulators of 2 m length and one 25 m long undulator in the South, and an equivalent arrangement could be added in the North. The beta functions are 1 m, 2.5 m and 12.5 m in the center of these undulators respectively but a flexible lattice can produce larger beta functions easily. Currently 18 beamlines and their science case are being investigated. The undulator length are: 25 m for 2, 5 m for 9, 2 m for 2, 1 m for 1, 2 m for 3 undulators in the 2.5 GeV loop in the East, and one diagnostic undulator. These studies cover the areas of: phase imaging and topography, coherent diffraction and XPCS microscopy on the nm scale, nanoscope and nanoprobe TXM and STXM to nm resolution, protein crystallography, inelastic X-ray scattering, femtosecond timing, resonant scattering, SAX and XPCS for mesoscopic science, and general material science, e.g. at high pressures. The undulators at 2.5 GeV would be for soft X-ray studies.

## OPTICS

The loop (3) connecting the two linacs was chosen so as to produce an acceptable emittance increase due to synchrotron radiation. After appropriate nonlinear correction, the dynamics does not lead to emittance growth for a 0.2% energy spread beam that one obtains for 6° off-crest ac-

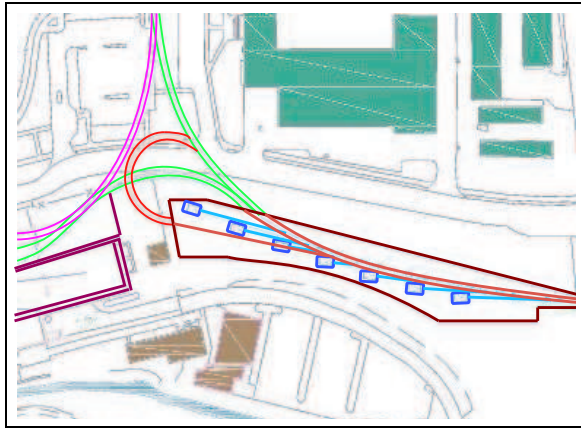

Figure 9: The beamline connecting the linac an the CESR ring. undulator beam lines are shown, but a CW FEL could also be operated in this region.

celeration, as required for compressing a 2 ps long bunch to 100 fs after the linac. This loop could also be used for energy spread reduction by running the second linac  $-6^\circ$  off-crest as discussed in [6].

## REFERENCES

- [1] I.V. Bazarov, C.K. Sinclair, *Multivariate optimization of a high brightness dc gun photoinjector*, Physical Review ST-AB, Volume 8, 034202 (2005)
- [2] H.Padamsee et al., *An Overview of the Cryomodule for the Cornell ERL Injector*, proc. of EPAC04 (2004)
- [3] I.V. Bazarov, *Overview of Energy Recovery Linacs*, Proceedings of PAC05 (2005)
- [4] G.H. Hoffstaetter et al., *The Cornell ERL Prototype Project*, proc. of PAC03, Portland/OR (2003)
- [5] S.M. Gruner, M. Tigner (eds.), *Phase I ERL Synchrotron Light Source at Cornell University*, Report CHES-01-003
- [6] I.V. Bazarov, G.H.Hoffstaetter, *Lattice options for a 5GeV light source at Cornell*, proc. of PAC03, Portland/OR (2003)
- [7] M. Borland, *elegant: A Flexible SDDS-Compliant Code for Accelerator Simulation*, APS LS-287 (2000)
- [8] I.V. Bazarov, G.H. Hoffstaetter, *Multi-pass Beam-breakup: Theory and Calculation*, proc. of EPAC04 (2004)
- [9] C. Tennant et al., *Experimental investigation of beam breakup in the Jefferson Laboratory 10kW REL upgrade*, Proceedings of PAC05 (2005)
- [10] G.H. Hoffstaetter et al., *A Lattice for a 5GeV ERL in the CESR Tunnel*, proc. of PAC03, Portland/OR (2003)

