

UPDATE REPORT

Acceleration of Polarized Protons to 920 GeV at HERA^{*†}

SPIN Collaboration

Michigan, Indiana, IHEP-Provino

JINR-Dubna, Moscow, INR-Moscow, BINP-Novosibirsk

KEK, TRIUMF

DESY Polarization Team

DESY, BINP, INR-Moscow

During January 1997 to June 1999, the SPIN Collaboration and the DESY Polarization Team have tried to extend and refine the 8 November 1996 Report on “Acceleration of Polarized Protons to 820 GeV/c at HERA” (UM-HE 96-20). The main areas of this new work are:

- increasing the accumulated polarized proton intensity,
- providing adequate spin stability with four (or more if absolutely necessary) Siberian snakes, probably by reducing HERA’s emittance and rms orbit distortions during or after its Luminosity Upgrade.

As indicated in the 1996 Report all other problems appear to have straightforward solutions using existing techniques. The first Section of this Update Report summarizes the changes needed in each accelerator for polarized proton acceleration; it also contains a possible Schedule and Budget for the polarized proton beam project. The rest of the Report describes the new work on beam intensity and spin stability which might allow one to accelerate polarized protons and to perform polarized proton experiments at 920 GeV. *If some inexpensive way can be found to overcome HERA’s rather strong depolarizing resonances with only 4 Siberian snakes*, then the total cost of the project should be about DM 24 Million.

TABLE OF CONTENTS

Section 1. Introduction and overview	3
Section 2. High intensity polarized H ⁻ source	11
Section 3. Spin motion at high energy in HERA-p	17
Section 4. Spin matching	25
Section 5. Polarization in HERA	31
Section 6. Some tentative simple polarized beam ideas	41

* Supported by research grants from DESY and the U.S. Department of Energy.

† Dedicated to the memory of Prof. Bjorn Wiik who supported this challenging and interesting study.

SPIN@HERA Collaboration

L. V. Alexeeva^a, V. A. Anferov, B. B. Blinov, D. D. Caussyn^b, A. W. Chao^c, E. D. Courant^d,
 D. G. Crabb^e, Ya. S. Derbenev, S. E. Gladysheva, T. Kageya, D. Yu. Kantsyrev^a, F. Z. Khiari^f,
 S. V. Koutin, A. D. Krisch, A. M. T. Lin, W. Lorenzon, V. G. Luppov, D. C. Peaslee, R. A. Phelps^g,
 G. P. Ramsey^h, L. G. Ratner, R. S. Raymond, D. S. Shoumkin^a, K. V. Sourkont^a, J. A. Stewartⁱ,
 S. M. Varzar^a, V. K. Wong

THE UNIVERSITY OF MICHIGAN, ANN ARBOR, U.S.A.

J. M. Cameron, C. M. Chu, T. B. Clegg^j, V.P. Derenchuk, D. L. Friesel, S. Y. Lee, M. G. Minty^c,
 T. Rinckel, P. Schwandt, J. Sowinski, F. Sperisen, E. J. Stephenson, B. von Przewoski
 INDIANA UNIVERSITY CYCLOTRON FACILITY, BLOOMINGTON, U.S.A.

Yu. M. Ado, P. N. Chirkov, V. N. Grishin, V. A. Kachanov, Yu. V. Kharlov, V. Yu. Khodyrev,
 O. I. Kisly, V. V. Mochalov, S. B. Nurushev, D. I. Patalakha, A. F. Prudkoglyad, V. V. Rykalin,
 V. P. Sakharov, P. A. Semenov, V. L. Solovianov, V. P. Stepanov, L. M. Tkachenko, V. A. Teplyakov,
 S. M. Troshin, N. E. Tyurin, A. G. Ufimtsev, M. N. Ukhanov, A. V. Zherebtsov
 INSTITUTE OF HIGH ENERGY PHYSICS, PROTVINO, RUSSIA

N. S. Borisov, V. V. Fimushkin, V. A. Nikitin, P. V. Nomokonov, A. V. Pavlyuk, Yu. K. Pilipenko,
 V. B. Shutov
 JOINT INSTITUTE FOR NUCLEAR RESEARCH, DUBNA, RUSSIA

A. I. Demianov, A. A. Ershov, A. M. Gribushin, N. A. Kruglov, A. S. Proskuryakov,
 A. I. Ostrovidov, L. I. Sarycheva, N. B. Sinejv
 MOSCOW STATE UNIVERSITY, MOSCOW, RUSSIA

A. S. Belov, L. P. Netchaeva, Yu. V. Plohinskii
 INSTITUTE FOR NUCLEAR RESEARCH, MOSCOW, RUSSIA

V. I. Davydenko, G. I. Dimov, V. G. Dudnikov
 BUDKER INSTITUTE OF NUCLEAR PHYSICS, NOVOSIBIRSK, RUSSIA

Y. Mori, C. Ohmori, H. Sato, T. Toyama, K. Yokoya
 KEK & INS-TOYKO, TSUKUBA, JAPAN

P.P.J. Delheij, G. Dutto, C.D.P. Levy, C.A. Miller, T. Sakae^k, P.W. Schmor, W.T.H. van Oers,
 A. N. Zelenski^l
 TRIUMF, VANCOUVER, CANADA

The spokesperson for the SPIN Collaboration is:

A. D. Krisch	Telephone: 734-936-1027
Randall Laboratory of Physics	Telefax: 734-936-0794
University of Michigan	E-mail: krisch@umich.edu
Ann Arbor, Michigan 48109-1120 USA	

Permanent address:

<i>a</i> Moscow State Univ.	<i>d</i> Brookhaven Nat. Lab	<i>g</i> IBM	<i>j</i> TUNL
<i>b</i> Florida State Univ.	<i>e</i> Univ. of Virginia	<i>h</i> Loyola; Argonne	<i>k</i> Kyushu Univ.
<i>c</i> SLAC	<i>f</i> King Fahd Univ.	<i>i</i> Univ. of Liverpool	<i>l</i> INR-Moscow

DESY Polarization Team

D.P. Barber, K. Heinemann, G. Hoffstätter, J. Maidment, M. Vogt DESY, HAMBURG, GERMANY

V.I. Ptitsin, Yu.M. Shatunov BINP, NOVOSIBIRSK, RUSSIA

V.V. Balandin, N.I. Golubeva INSTITUTE FOR NUCLEAR RESEARCH, MOSCOW, RUSSIA

1 Introduction and overview

This Update Report is focused on two challenging steps needed to accelerate a spin-polarized proton beam [1, 2, 3] to 920 GeV at the DESY complex. This polarized proton beam capability would provide a powerful tool for high energy physics in response to the growing interest in spin at high energy. Very interesting e^+e^- polarization results have recently been obtained at SLC [4]; there have been several major $e-p$ polarization experiments at HERA [5] and SLAC [6] in addition to the SMC [7] and the future COMPASS [8] $\mu-p$ polarization experiments at CERN; moreover, several $p-p$ polarization experiments should soon run at RHIC [9].

A polarized proton beam in HERA could be used simultaneously in two modes. The polarized proton beam could be collided with HERA's existing polarized electron beam at the H-1 and ZEUS collider-detectors to study the spin structure of protons, in particular, the structure function $g_1(x, Q^2)$ at small x values near 10^{-4} . Moreover, the polarized proton beam could be scattered from an internal polarized proton jet target to study both two-spin and one-spin effects in $p-p$ elastic and inclusive cross sections. A great deal of interesting physics could be done with a polarized proton beam at HERA as discussed in Sections 2, 3 and 4 of the earlier Report [1] and at a number of workshops at DESY [12, 13, 14].

Accelerating polarized protons to 920 GeV would require changes in each acceleration stage at DESY, except for the LINAC. These changes are shown in Fig. 1.1, and are discussed in Sections 5–13 of the earlier Report [1]. Even taken together, the two reports are certainly not a full design report; whenever possible, the different options are presented. Some of the proposed polarized proton beam hardware is briefly discussed below.

1.1 Polarized beam acceleration

A state-of-the-art polarized H^- ion source must be acquired and installed. This might be either an atomic beam source (ABS), or an optically pumped polarized ion source (OPPIS). Both types of sources are constantly being improved; the best ABS has now achieved a current of 1 mA in pulsed operation, while the best OPPIS recently obtained a 5 mA current in 100 μ sec pulses with an emittance of 2π mm · mrad. These intensities are still well below the present unpolarized source intensity, but they may improve significantly, as discussed in Section 2. Moreover, beam accumulation techniques may significantly increase the polarized beam intensity in HERA, as discussed in Section 13 of the earlier Report [1]. We hope that, with both source and accumulation improvements, the polarized proton beam intensity in HERA might reach the present unpolarized beam intensity of about 80 mA (about 10^{13} stored protons) or even the planned unpolarized intensity of 150 mA [13].

The polarized H^- ions from the source would be first accelerated to 750 keV by a new RFQ; then they would be accelerated in the existing LINAC to 50 MeV or to about 160 MeV in a new LINAC or Booster synchrotron. Polarimeters installed after the RFQ and the LINAC would monitor the polarization at 750 keV and at the LINAC energy, respectively.

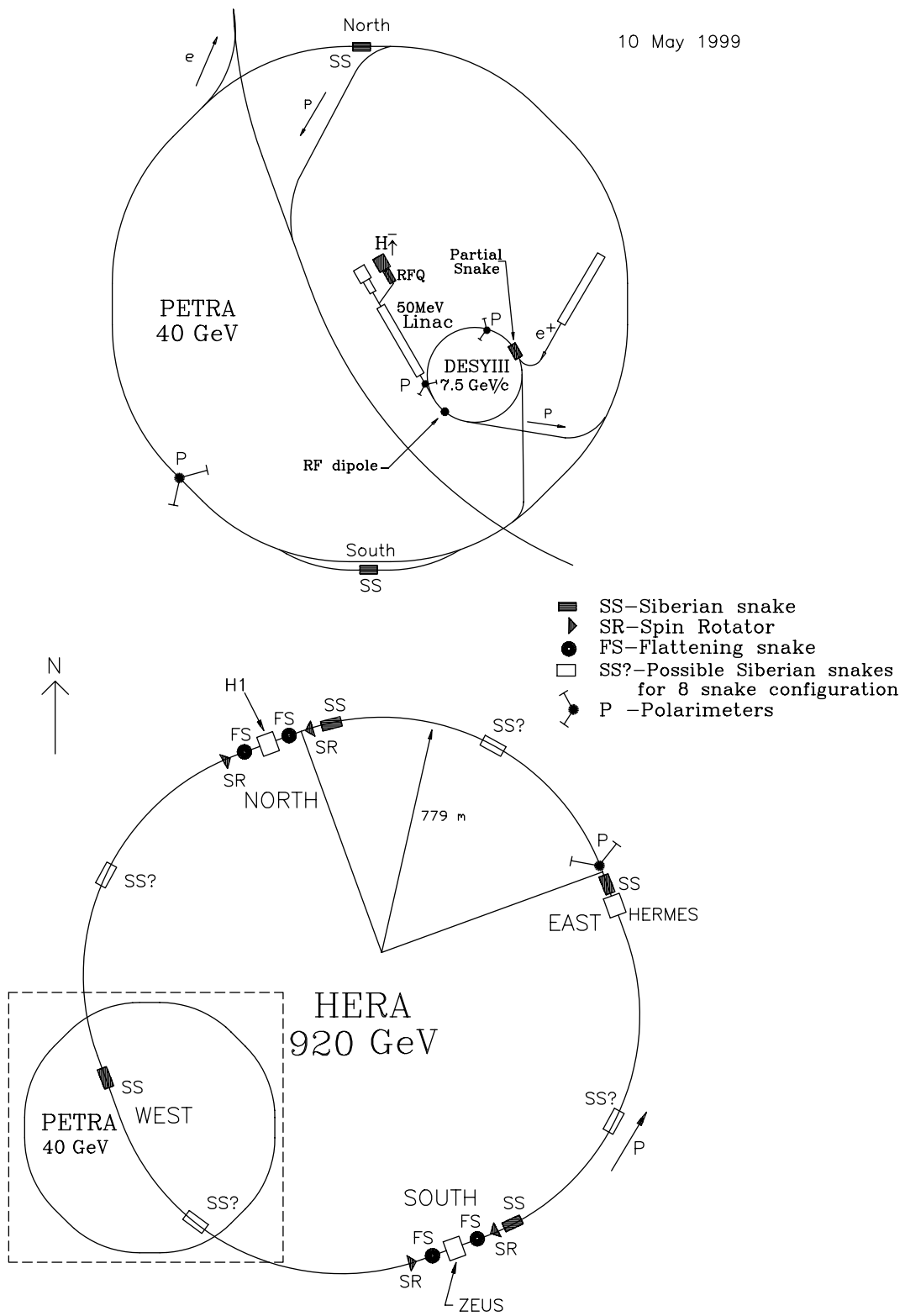

Figure 1.1: The proposed modifications for a 920 GeV polarized proton beam at DESY.

Acceleration through DESY III would require overcoming five strong depolarizing resonances. The one strong and about 13 weak imperfection resonances could be overcome using a solenoidal partial Siberian snake of about 5%, while the four strong intrinsic resonances could be overcome using either conventional tune-shifting pulsed quadrupoles or the new dipole kicker [10] or rf dipole technique [11]. A relative AGS-type internal polarimeter could easily monitor the polarization up to 7.5 GeV/c.

Two full Siberian snakes would be needed in PETRA to overcome its many strong depolarizing resonances. The snake design is somewhat difficult in PETRA because, at its 7.5 GeV/c injection momentum, full Siberian snakes would cause large orbit excursions. Nevertheless, we suggest that two, either cold or warm, fully-on Siberian snakes should operate in the South proton bypass and in the North straight section. An AGS-type relative polarimeter, in a short PETRA straight section, could monitor the polarization up to 40 GeV.

Accelerating polarized protons to 920 GeV in HERA would require at least four full Siberian snakes. Four superconducting Siberian snakes could easily be located near each of the four long straight sections as shown in Fig. 1.1. However these four snakes may be inadequate to overcome HERA's strong depolarizing resonances and thus provide spin stability. The DESY Polarization team has suggested many ways to further study this possible difficulty which they first discovered using their very detailed spin tracking programs.

It now appears that the four full Siberian snakes suggested for HERA are considerably less effective than the 6 snakes suggested earlier for the Tevatron; the benefit of an odd number of snake pairs was previously considered (26 snakes at SSC and 6 snakes at the Tevatron) [15, 2] but perhaps not fully understood. Installing 6 or 8 snakes in HERA would probably require replacing some existing HERA dipoles with shorter higher field dipoles. This replacement would probably be somewhat expensive and disruptive. Thus, the most promising path to polarized proton acceleration at HERA appears to be 4 easily installed Siberian snakes along with a reduction of the emittance and rms orbit distortions during or after HERA's Luminosity Upgrade.

In addition to the four, six or eight normal Siberian snakes, four "flattening snakes" should be placed in HERA's North and South collider-detector straight sections to compensate the spin rotation due to the nearby vertical bends. Spin rotators in these North and South straight sections could provide any spin orientation for the H1 and ZEUS Detectors. A CNI (Coulomb Nuclear Interference) polarimeter in HERA could give an absolute calibration of the beam polarization up to 920 GeV by making simultaneous beam and target measurements of the left-right asymmetry in p - p elastic scattering, using Michigan's polarized jet target. One might also install in HERA a relative AGS-type polarimeter and possibly an inclusive polarimeter. Spin rotators would probably be needed in both the 50 MeV and 40 GeV beam transport lines to maintain high polarization.

In summary, this Update Report is focused on possibly increasing even further polarized proton source intensities and on the most challenging problem facing the practical acceleration of polarized protons in HERA:

- providing adequate spin stability with four Siberian snakes, probably by reducing HERA's emittance and rms orbit distortions during or after its Luminosity Upgrade.

All other problems appear to have straightforward solutions using existing techniques.

1.2 Schedule

A possible schedule for commissioning the polarized proton beam is estimated in Fig. 1.2. This estimate assumes that the funding for this polarized proton beam project may become available in 2003 and that no other projects interfere with the commissioning.

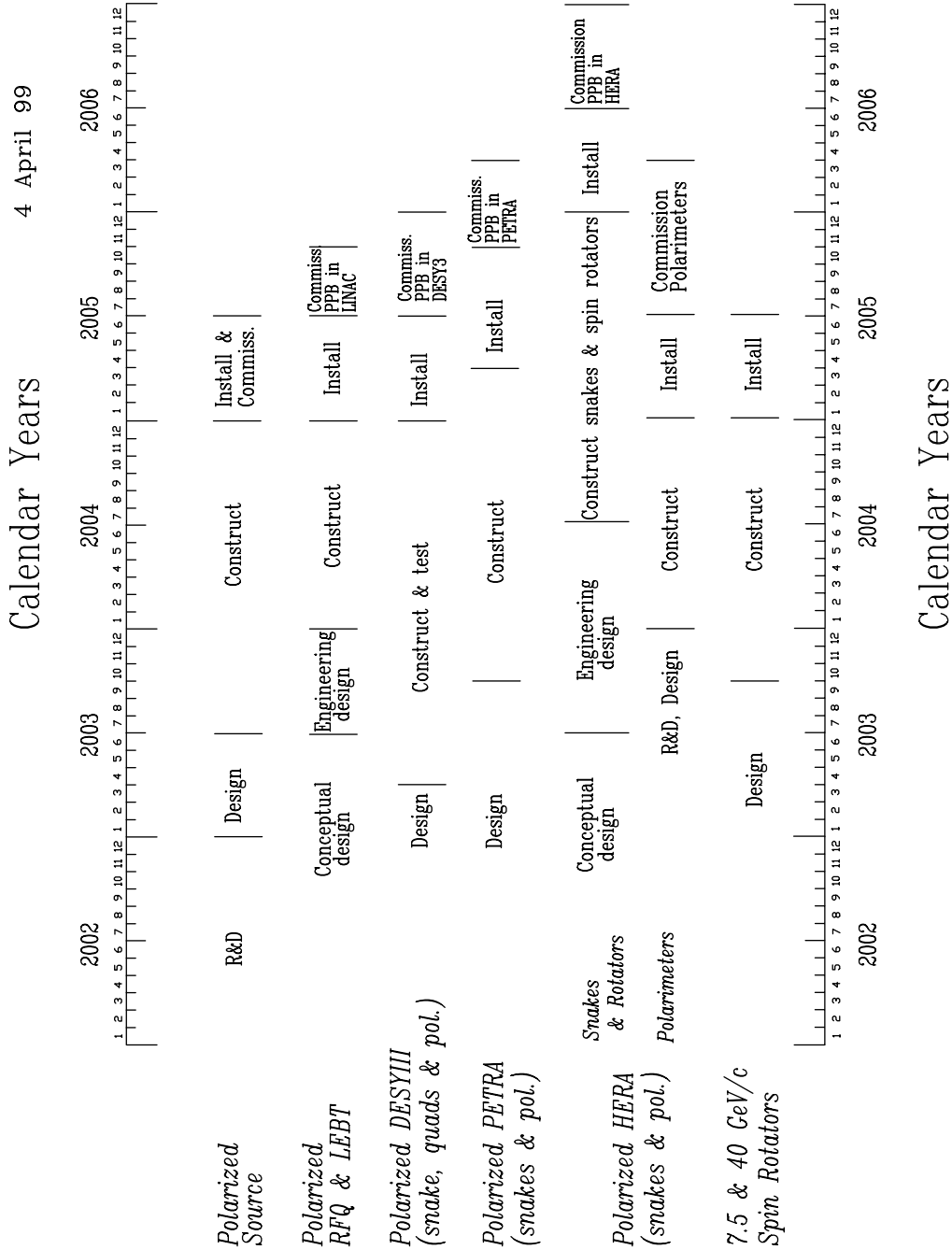

Figure 1.2: The schedule for commissioning a polarized proton beam in HERA.

1.3 Budget

The estimated total cost to obtain an 920 GeV polarized proton beam capability at DESY is given in **1999 DM**. Our estimate of about DM 24 Million seems a quite reasonable investment for the expected physics results. Moreover this cost might be considerably lower if the SPIN Collaboration fabricated some or all of the polarization hardware. *Note carefully that this estimate assumes that some inexpensive way is found to overcome the possible spin stability problem in HERA with only four Siberian snakes.*

Preaccelerator		DM 4.7 M
Polarized H ⁻ ion source	DM 3.0 M	
RFQ and power supply (20 keV to 750 KeV)	DM 0.7 M	
Low energy beam transport, switching magnets, and vacuum system	DM 0.7 M	
Building change	DM 0.3 M	
50 MeV LINAC		DM 0.2 M
50 MeV polarimeter (p-Carbon)	DM 0.2 M	
7.5 GeV/c DESY III Booster		DM 0.8 M
Solenoid partial Siberian snake (ramped warm)	DM 0.3 M	
Pulsed quadrupoles, kicker or rf dipole with power supplies	DM 0.3 M	
7.5 GeV/c polarimeter (Relative)	DM 0.2 M	
40 GeV PETRA Ring		DM 2.3 M
Two warm Siberian snakes	DM 1.1 M	
Power supplies and connections	DM 0.3 M	
40 GeV polarimeters (CNI, Relative, and possibly Inclusive)	DM 0.9 M	
920 GeV HERA Ring		DM 9.3 M
4 Superconducting Siberian snakes	DM 2.2 M	
4 Superconducting flattening snakes	DM 2.2 M	
4 Superconducting spin rotators	DM 1.7 M	
Power supplies and cryogenic connections	DM 1.7 M	
920 GeV polarimeters (CNI, Inclusive, Relative, Elastic)	DM 1.2 M	
Spin Flippers	DM 0.3 M	
Miscellaneous		DM 1.9 M
Transfer line spin rotators	DM 0.6 M	
Computers, control modules, cables, and interface	DM 1.3 M	
ACCELERATOR SUBTOTAL		DM 19.2 M
Contingency (25%)		DM 4.8 M
ACCELERATOR TOTAL		DM 24.0 M

1.4 Physics goals

Spin effects in high energy collisions provide crucial information about the properties of the elementary particles and their fundamental interactions. A 920 GeV spin-polarized proton beam at HERA would allow many important experiments including: searches for new particles; tests of perturbative QCD; tests of nonperturbative QCD; and measurements of the transverse and longitudinal spin structure of the nucleon.

A major incentive for accelerating polarized protons in HERA is their use in fully polarized e - p collisions using the existing HERA 27.5 GeV polarized electron beam and the existing H-1 and ZEUS detectors [14]. A detailed analysis of how these studies would be aided by proton polarization was recently discussed at May 99 DESY Workshop [12].

The SPIN Collaboration is particularly interested in studying one-spin and two-spin effects in proton-proton inclusive production of π 's, K 's, p 's, and hyperons. These experiments could be done in the East Hall by colliding HERA's 920 GeV polarized proton beam with the Michigan's Mark II ultra-cold proton-spin-polarized atomic hydrogen jet target as shown in Fig. 1.3.

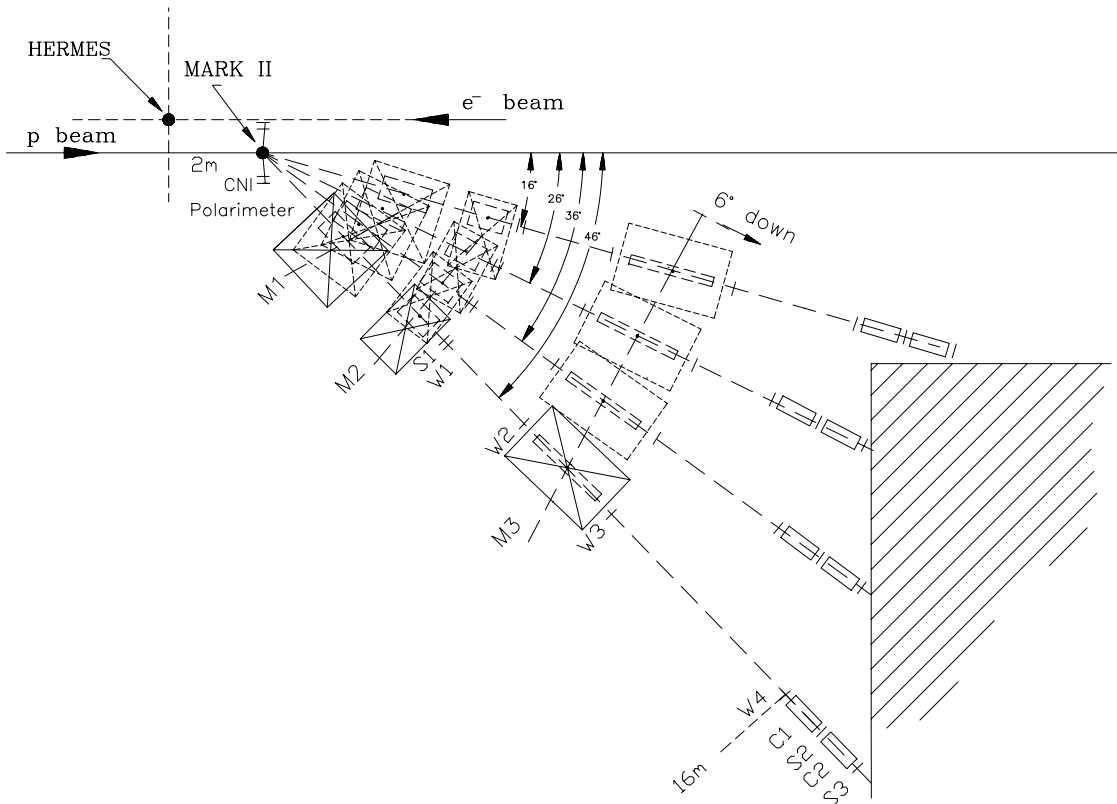

Figure 1.3: Inclusive spectrometer layout in the East Hall. The four spectrometer lines are set at angles of 16° , 26° , 36° and 46° from the proton beam line. At each setting, the M1 and M2 bending magnets horizontally bend particles produced at other angles into the spectrometer line. Magnet M3 vertically bends the particles down by 6° ; the wire chambers W1, W2, W3 and W4 then determine precisely the particle momentum. The Cherenkov counters C1 and C2 identify particles. The scintillators S1, S2 and S3 provide triggers and time of flight information.

Note: The CNI Polarimeter would be used to calibrate the proton beam's polarization.

References

- [1] SPIN Collaboration and DESY Polarization Team, “*Acceleration of polarized protons to 820 GeV at HERA*”, University of Michigan Report UM-HE 96-20 (1996).
- [2] SPIN Collaboration, “*Acceleration of polarized protons to 120 GeV and 1 TeV at Fermilab*”, University of Michigan Report UM-HE 95-09 (1995).
- [3] D.P. Barber, “*Prospects for polarized protons at HERA*”, International School of Nucleon Structure, Erice, Sicily, August 1995; D.P. Barber, “*Possibilities for polarized protons at HERA*”, in Prospects of spin physics at HERA, DESY–Zeuthen, August 1995, DESY Report 95–200; G. Hoffstätter, “*Polarized protons in HERA*”, in Proc. of the DESY Accelerator Group Seminar, DESY Report 96-05, May 1996; V. Balandin, N. Golubeva and D.P. Barber, “*Studies of the behaviour of proton spin motion in HERA-p at high energies*”, DESY Report M-96-04, May 1996.
- [4] SLD Collaboration: K. Abe *et al.*, Phys. Rev. Lett. **79**, 804 (1997); Phys. Rev. Lett. **78**, 4691 (1997).
- [5] HERMES Collaboration: A. Airapetian *et al.*, Phys. Lett. **B442**, 484 (1998).
- [6] E143 Collaboration: K. Abe *et al.*, Phys. Rev. Lett. **74**, 346 (1995); Phys. Lett. **B364**, 61 (1995); Phys. Rev. **D58**, 112003 (1998).
- [7] SMC Collaboration: D. Adams *et al.*, Phys. Lett. **B329**, 399 (1994); Phys. Rev. **D56**, 5330 (1997); B. Adeva *et al.*, Phys. Lett. **B412**, 414 (1997).
- [8] COMPASS Collaboration: G. Baum *et al.*, “*Common Muon and Proton Apparatus for Structure and Spectroscopy*”, CERN/SPSLC 96-14, March 1996.
- [9] Y. Makdisi, Proc. 11th International Symposium on High Energy Spin Physics, Bloomington 1994, AIP Conf. Proc. **343**, 75 (1995).
- [10] D.A. Crandell *et al.*, Phys. Rev. Lett. **77**, 1763 (1997).
- [11] M. Bai *et al.*, Phys. Rev. Lett. **80**, 4673 (1998).
- [12] Workshop on Polarized Protons at High Energies, 17-20 May 1999, DESY-Hamburg.
- [13] J. Feltesse, Proc. of Workshop on Future Physics at HERA (1996).
- [14] Workshops on physics with polarized protons at HERA, Ed. by A. de Roeck and T. Gehrman, DESY-Zeuthen, March 1997 and September 1997.
- [15] SPIN Collaboration “SSC EOI-001” SSC Letter of Intent, 28 November 1990.

2 A pulsed OPPIS with atomic hydrogen injector

The ideal requirements for the polarized H^- source for DESY are a 20 mA current in 100 μs pulses at 0.25 Hz within a normalized emittance of 2π mm mrad for 2σ (95%), with a polarization of 80%. A 1.64 mA dc polarized H^- ion current was obtained at TRIUMF with the promise of further increases to the 2–3 mA range. However, the electron cyclotron resonance (ECR) type primary proton source used at the TRIUMF optically pumped polarized ion source (OPPIS) has a comparatively low emission current density and high beam divergence. This limits further current increases and gives rise to inefficient use of the available laser power for optical pumping.

In pulsed source operation, suitable for application at high energy accelerators, the ECR source limitations have been overcome by using instead a high brightness proton source outside the magnetic field [1]. In this OPPIS, shown in Fig. 2.1, a very intense pulsed, high brightness 4 keV atomic H beam is injected into a solenoidal field containing a pulsed-gas He cell ionizer and the optically pumped polarized Rb vapor cell. The injected H atoms are ionized in the He with 80% efficiency to form a small emittance, intense proton beam that then enters the polarized Rb vapor cell. The proton beam picks up polarized electrons from the Rb to become a beam of electron-spin polarized H. Both the He cell and Rb cell are in the same solenoidal 2.5 T field, which is required to preserve the electron-spin polarization. Then, in the same way as the existing dc TRIUMF OPPIS, the polarization is transferred to the nucleus via a Sona transition and an unpolarized electron is picked up in a Na vapor negative ionizer cell, resulting in a proton-spin polarized H^- beam that is then accelerated to higher energies.

The original prototype [1] had a biased He cell to separate (in energy) the protons and remaining atomic H leaving the cell. Another version would take advantage of spin-exchange polarization between atomic H and polarized Rb atoms [2, 3, 4]. A Rb thickness of 5×10^{14} atoms cm^{-2} is required for significant spin-exchange polarization to occur. The Rb vapor could be polarized using the high power available from a pulsed laser, provided a cell length ≥ 50 cm was used in order to keep the Rb density below the radiation trapping limit. In that case the atomic H leaving the He cell could also be polarized, by spin-exchange collisions with the Rb atoms, and it would not be necessary to bias the He cell. The current would then be higher because all the beam would be used and the beam optics would be improved. Fig. 2.2 shows the calculated atomic H electronic polarization at the exit of the Rb cell, as a function of the Rb vapor thickness, assuming 100% Rb polarization [5]. Experimentally measured spin-exchange cross sections were used in these calculations.

We previously described a proposal for a pulsed 20 mA H^- OPPIS and preliminary results of tests at BINP Novosibirsk [6, 7]. Since then, the pulsed OPPIS has been developed further on a test stand at TRIUMF. The work has concentrated on the intense atomic H injector, based on a BINP Novosibirsk prototype. The test stand consisted of a setup that simulated the geometry of a working polarized source, minus the He ionizer and polarized Rb vapor cells necessary for actual polarized operation.

The atomic hydrogen injector (shown in Fig. 2.3) consists of a primary plasmatron proton

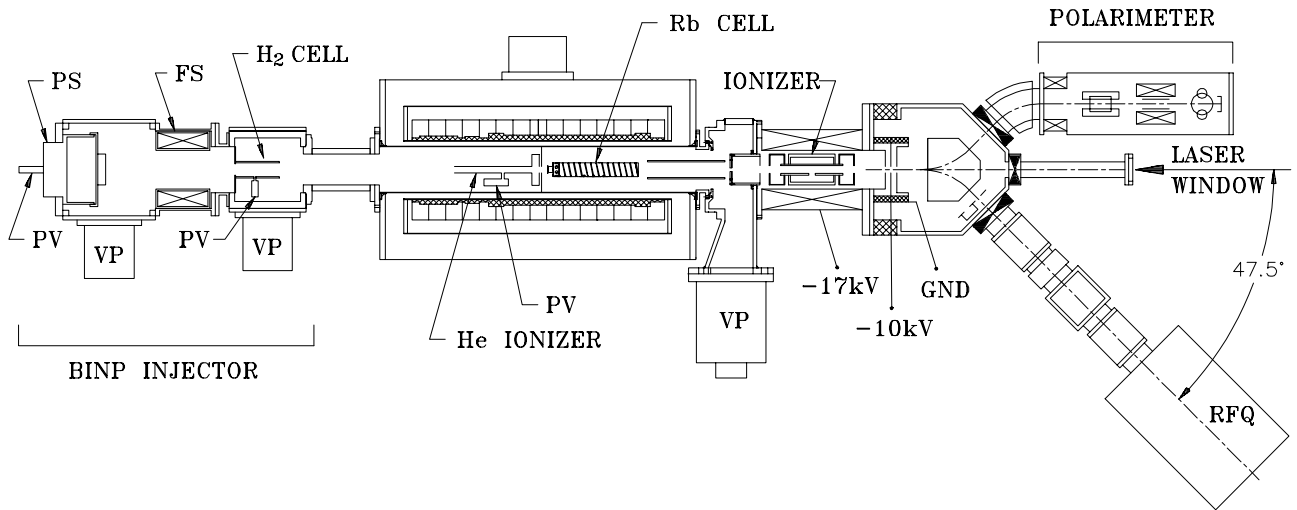

Figure 2.1: Proposed pulsed OPPIS, configured for 21 keV beam energy at injection to an RFQ: PS – plasmatron proton source; PV – pulsed valve; VP – vacuum pump; FS – focusing solenoid; GND – ground. The 47.5° magnetic bend preserves longitudinal polarization.

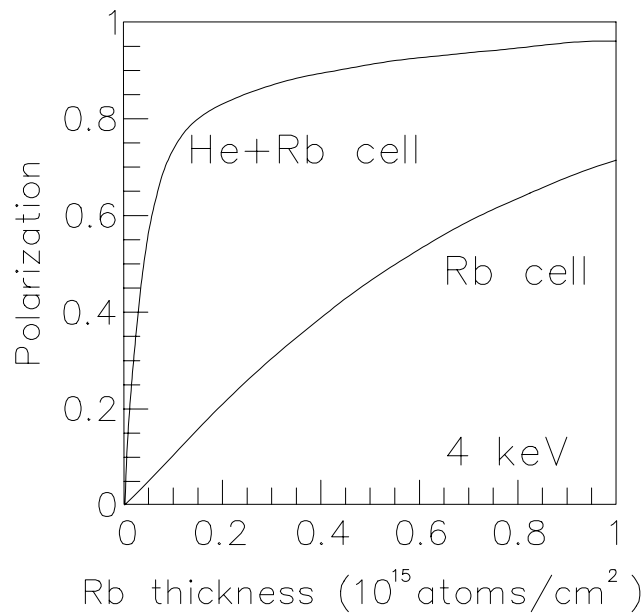

Figure 2.2: Hydrogen electronic polarization as a function of Rb vapor thickness, at a beam energy of 4 keV. Top line – combined charge- and spin-exchange polarization; bottom line – spin-exchange polarization only.

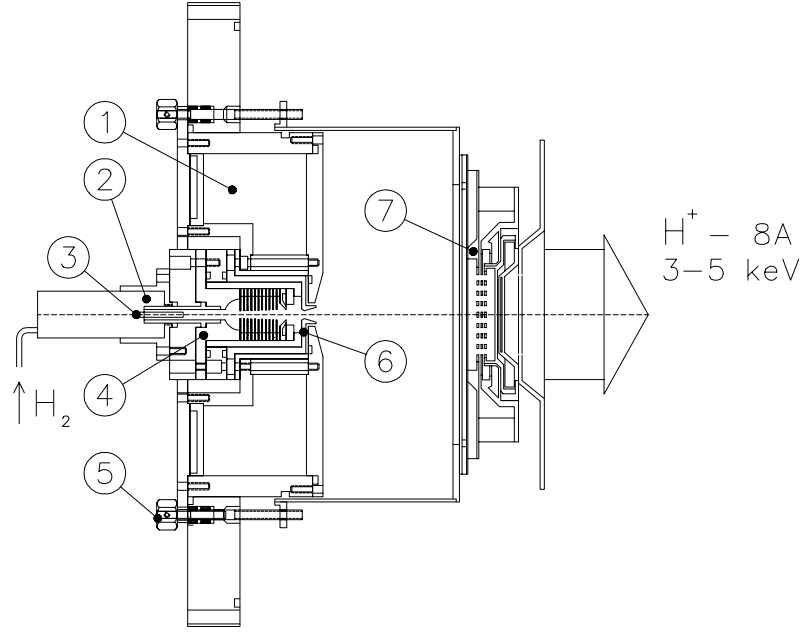

Figure 2.3: The BINP-type proton source: (1) solenoid; (2) pulsed valve; (3) trigger electrode; (4) cathode; (5) alignment screw; (6) anode; (7) proton extraction grids.

source, a focussing solenoid and a pulsed H_2 gas neutralizer. A unique feature of the proton source is the efficient plasma cooling during expansion between the plasma generator and the extraction electrodes; the plasma temperature drops to about 0.2 eV at a distance of 10 cm from the generator, where the extraction system is positioned. In experiments at TRIUMF, a 4 cm diameter, 4-grid multiwire accel-accel-decel extraction system, taking full advantage of the low temperature plasma, was used to produce high proton currents at beam energies below 5 keV. The grids are made of 0.2 mm diameter molybdenum wire, with 1.0 mm spacing between the wires. The wires are positioned on the electrode mounts in precisely cut grooves, and spot welded in place. The mutual grid alignment accuracy is better than 0.02 mm. The gaps between the first, second, third and fourth grids are 0.8 mm, 1.2 mm and 2.0 mm, respectively. At a beam energy of 4 keV, the optimal extraction is obtained by applying voltages to the grids of +4.0 kV (first grid), +3.2 kV, -7.0 kV and +0.1 kV (last grid). Total extracted proton current is ~ 8 A. The proton extraction system and the plasma expansion cup are adjustable to provide the required accuracy of the low divergence beam alignment through the long polarizer.

Space charge compensation is important in such high current, low energy proton beams. It is improved using a positively biased grid in the centre of the focussing solenoid, and by injecting CO_2 or Freon into the solenoid.

The atomic H beam was transmitted through a Na negative ionizer. The beam intensity was measured both by calorimetry and from ionization in the Na cell. Fig. 2.4 shows the measured H^- ion current and H^0 beam intensity within the Na ionizer acceptance as functions of the beam energy. Fig. 2.5 shows typical pulse shapes of the extraction voltage and H^- beam current. About 90% of this current can be polarized to 80% by using a combination of charge- and spin-exchange techniques. In the other option using a biased He cell, a higher

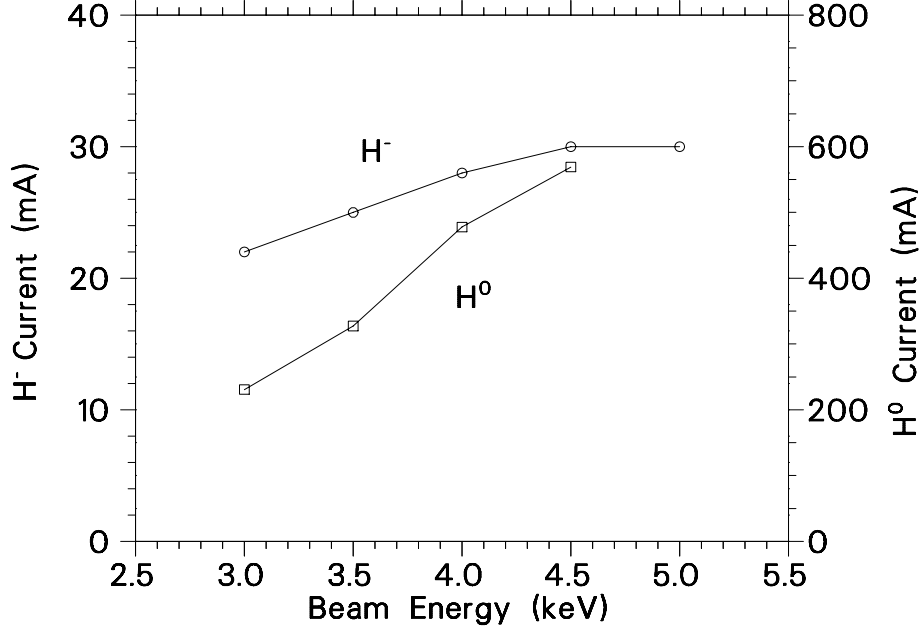

Figure 2.4: H^- ion current and H^0 beam intensity within the Na negative-ionizer acceptance versus beam energy.

polarization of 85% may be obtained, but the H^- current would be less by a factor of two due to charge-exchange inefficiencies in the He and Rb cells and due to beam optics effects.

A flashlamp-pumped pulsed Ti:sapphire laser used for optical pumping of the Rb vapor is being developed in parallel with the source work. It produces pulse durations of $80 \mu\text{s}$ (FWHM) at a repetition rate of 1 Hz, using a simple power supply. The laser cavity is tuned with a 2-plate birefringent filter and a 0.5 mm thick etalon, producing a laser bandwidth of 15 GHz. The peak power density is 28 W/cm^2 over the 3 GHz Doppler broadened absorption width of Rb, for a 2 cm diameter laser beam. Previous results have shown that 14 W/cm^2 is enough to produce nearly 100% Rb polarization [8]. Future development will concentrate on extending the pulse duration and repetition rate of the laser.

Following the test stand measurements, the test stand was dismantled and the atomic hydrogen injector was moved to the operational TRIUMF OPPIS, for further pulsed source development between scheduled polarized beam runs at TRIUMF. The next steps in the development are to demonstrate the operation of a complete source that includes a biased He ionizer cell, a piezoelectric gas valve that can operate in the high magnetic field [9], and an optically pumped polarized Rb vapor cell, and to measure the H^- polarization with the TRIUMF Lamb-shift polarimeter [10]. Of course, the He cell bias can be removed and that option explored as well. Use of the full TRIUMF OPPIS as a development stand will permit testing of the complete pulsed OPPIS, using the existing superconducting solenoid to generate a fairly flat 1.2 T field over a length of 70 cm that will encompass both the He and Rb cells. The resulting polarization will be limited in that case to about 60% due to the relatively low field, predicted theoretically [11] and later verified experimentally [10, 12]. A dedicated pulsed OPPIS would require a flat-topped field of 2.5 T over a length of at least 80 cm to reach high polarization. The existing solenoid cannot produce this high a field over

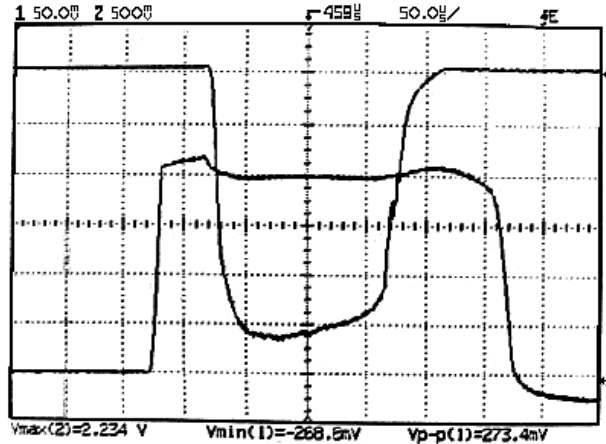

Figure 2.5: H⁻ beam current (negative pulse) and 4.0 kV extraction voltage, 50 μs/div.

the required length.

2.1 Addendum

Since the above report was written, the complete pulsed OPPIS was assembled and tested with a 10 kG field. An H⁻ current of 5.0 mA at 60% polarization was achieved, at a beam energy of 2 keV. Further development was cut short by the scheduled May - June polarized beam run.

References

- [1] A.N. Zelenski *et al.*, Nucl. Instrum. Meth. A**245**, 223 (1986).
- [2] D.R. Swenson and L.W. Anderson, J. Phys. B **18**, 4433 (1985).
- [3] A.N. Zelenski and S.A. Kokhanovski, AIP Conf. Proc. 293, 164 (1994).
- [4] A.N. Zelenski *et al.*, Proc. 4th European Particle Accelerator Conf. (London, 1994), Eds. V. Sullar, Ch. Petit-Jean-Genaz, World Scientific, Singapore 1994, p. 205.
- [5] A.N. Zelenski, Proc. International Workshop on Polarized Beams and Polarized Gas Targets (Cologne, 1995), Eds. H. Paetz gen. Schieck, L. Sydow, World Scientific, Singapore 1996, p.111.
- [6] SPIN Collaboration, "Acceleration of polarized protons to 820 GeV at HERA", University of Michigan report UM HE 96-20, (1996).
- [7] A.N. Zelenski *et al.*, Rev. Sci. Instrum. **67**, 1359 (1996).
- [8] C.D.P. Levy et al, Proc. International Workshop on Polarized Beams and Polarized Gas Targets (Cologne, 1995), Eds. H. Paetz gen. Schieck, L. Sydow, World Scientific, Singapore 1996, p.120.
- [9] Kindly supplied by C. Schmidt of Fermilab.
- [10] A.N. Zelenski *et al.*, Nucl. Instrum. Meth. A**334**, 285 (1993).
- [11] E.A. Hinds, W.D. Cornelius and R.L. York, Nucl. Instrum. Meth. **189**, 599 (1981).
- [12] Y. Mori, K. Ikegami, A. Takagi, S. Fukumoto, 1985 Particle Accelerator Conference (Vancouver), IEEE Trans. Nucl. Sci. NS-32, 1779 (1985).

3 Spin motion at high energy in HERA-p

3.1 Introduction

Intrinsic depolarizing resonances at the high energies of HERA-p can be very strong [1] and the strengths of the first order resonances can approach unity at the top end of the HERA energy range. For example figure 3.1 shows the strengths of first order resonances for the momentum range from 500 GeV/c to 1000 GeV/c with flattening snakes [2] for the optical configuration used in 1996 for acceleration up to full energy. The betatron tunes are fixed at $Q_x = 31.279$, $Q_y = 32.2725$ and $Q_s = 0.00064$ at 820 GeV/c. The resonance strengths were evaluated on a vertical phase space ellipse with an invariant emittance of 16π mm·mrad (2σ). The very strong resonances occur whenever the spin phase advance and the orbit phase

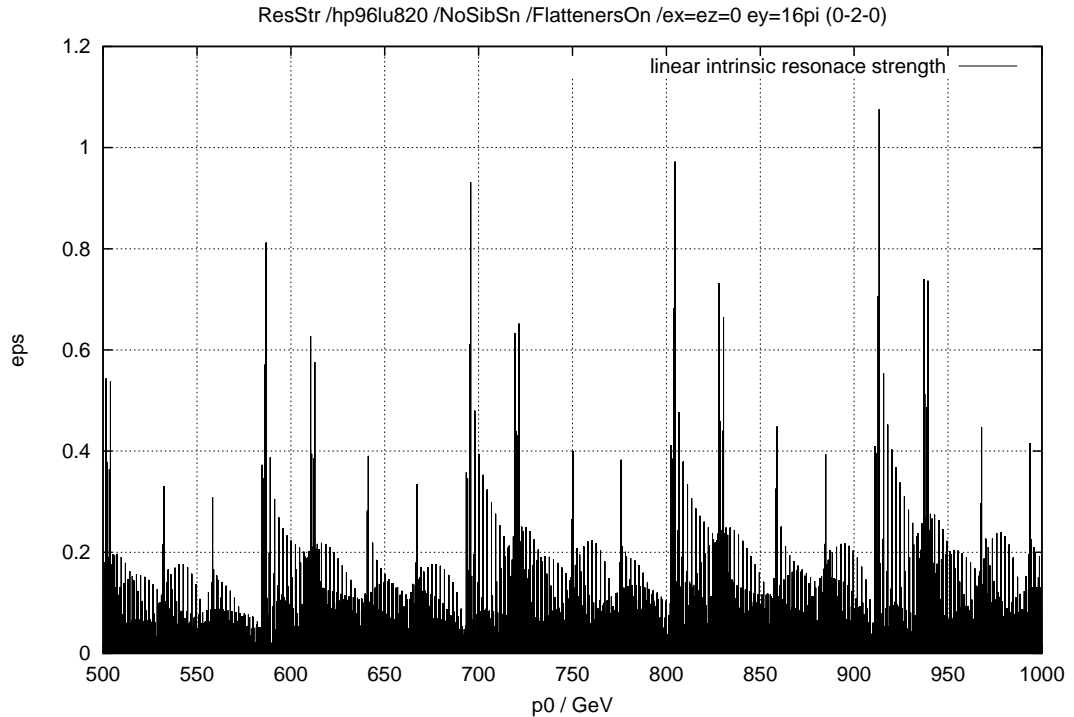

Figure 3.1: Resonance strengths in HERA-p with flattening snakes from 500 to 1000GeV/c for an invariant amplitude of 16π mm·mrad (2σ).

advance are in resonance in each FODO cell of the arc. Such very strong resonances can occur in 29 distinct energy domains during the ramp from 40GeV/c to 820GeV/c.

3.2 Acceleration of a polarized beam through resonances

The equilibrium state of a polarized beam is described by the invariant spin field (the \vec{n} -axis) [3]. The upper limit of the average polarization at equilibrium P_{lim} , which is given by the absolute value of the phase space average of \vec{n} , is small when the energy is close to that of a very strong depolarizing resonance [4]. For the calculations presented here the particles are not distributed over all of phase space but only on phase space torii. P_{lim} can be increased by the installation of Siberian Snakes but even with snakes, residual resonance structures (RRS's) can remain at or near the energies of the original resonances so that it is necessary to choose the snake scheme carefully as described below. In particular, the choice of the snake types and their parameters must be optimized. In the following we study the effects of 'horizontal' snakes, i.e. snakes whose spin rotation axes ('snake axes') lie in the horizontal plane. Similar kinds of detailed investigations by Balandin and Golubeva are described in [5].

3.2.1 Filtering

In HERA-p there is space for Siberian Snakes in four straight sections and, with a significant increase of cost, in the centers of the four arcs. To find the best choice for the orientations of the snake axes, we use the snake filtering algorithm [1] to maximize P_{lim} averaged over a specified momentum range. In particular, we tested all four and eight snake schemes for snakes with snake axes which lie at angles which are multiples of 22.5 degrees (for four snakes) and 45 degrees (for eight snakes) with respect to the radial direction.

3.2.2 Filtering with four snakes

Figure 3.2 (top) shows the variation of P_{lim} with momentum for the optics used in figure 3.1 with flattening snakes and with four snakes chosen by filtering with particles on a vertical phase space ellipse with an invariant emittance of 4π mm·mrad (1σ). Figure 3.2 (bottom) shows the resulting P_{lim} for an amplitude of 16π mm·mrad (2σ). Beginning in the East, the snake axes are at 90, -45, 0 and +45 degrees from the radial direction respectively. For figure 3.2, P_{lim} is calculated with the new version of the SODOM algorithm [6] which is embedded in the program SPRINT [4]. The \vec{n} -axis obtained from the SODOM algorithm agrees with that obtained using stroboscopic averaging in SPRINT. Even with filtering, RRS's remain and as can be seen in figure 3.2 their positions are strongly correlated with the positions of the original resonances. But the strengths of the RRS's need not be strongly correlated to the strengths of the original resonances. According to figure 3.2 (top), for a beam in which the particles only execute vertical betatron motion on the 1σ ellipse, the equilibrium polarization could reach almost 100 percent at the highest momentum.

However, the full energy can only be reached by acceleration through the RRS's and that can lead to depolarization if the acceleration is not sufficiently adiabatic. The result of a simulation of acceleration up to full energy is shown in figure 3.3 where P_{lim} (dotted curve in this and other figures) is plotted together with the ramped polarization P_{ramp} (crosses). The same set of optics is used as in figures 3.1 and 3.2 and at the beginning of the simulation the particles were on the surface of the phase space torus corresponding to horizontal, vertical, and longitudinal invariant emittances of 4π mm·mrad, 4π mm·mrad, and $1.78 \cdot 10^{-2}$ m·rad

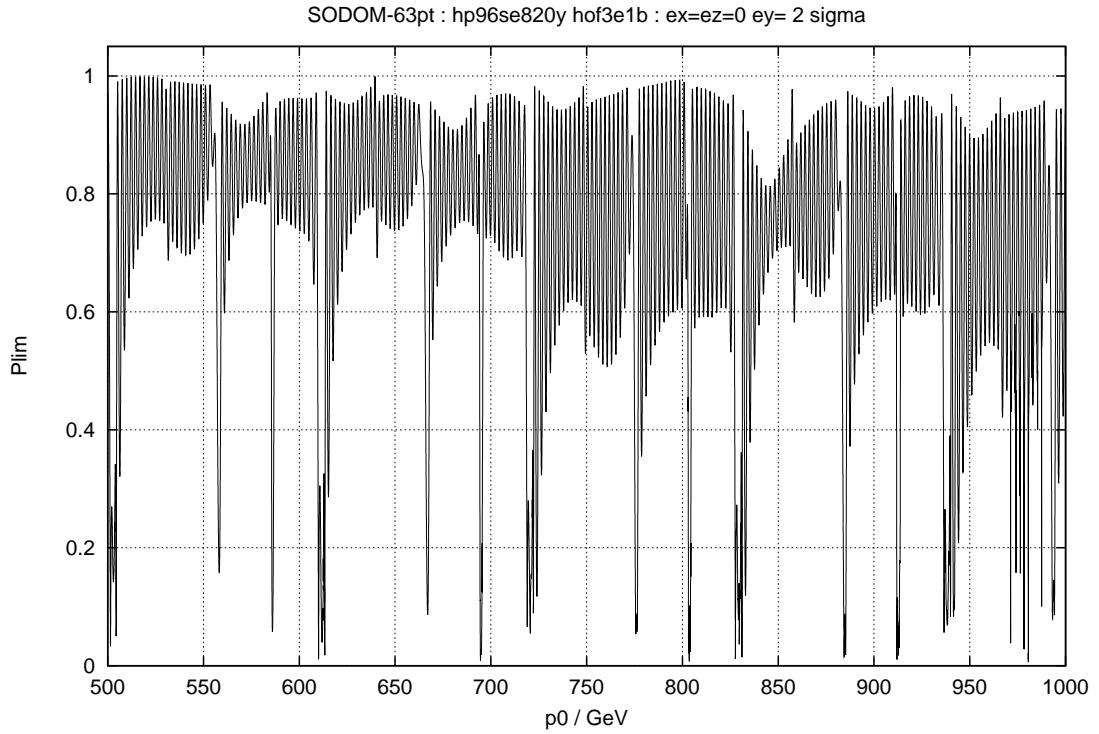
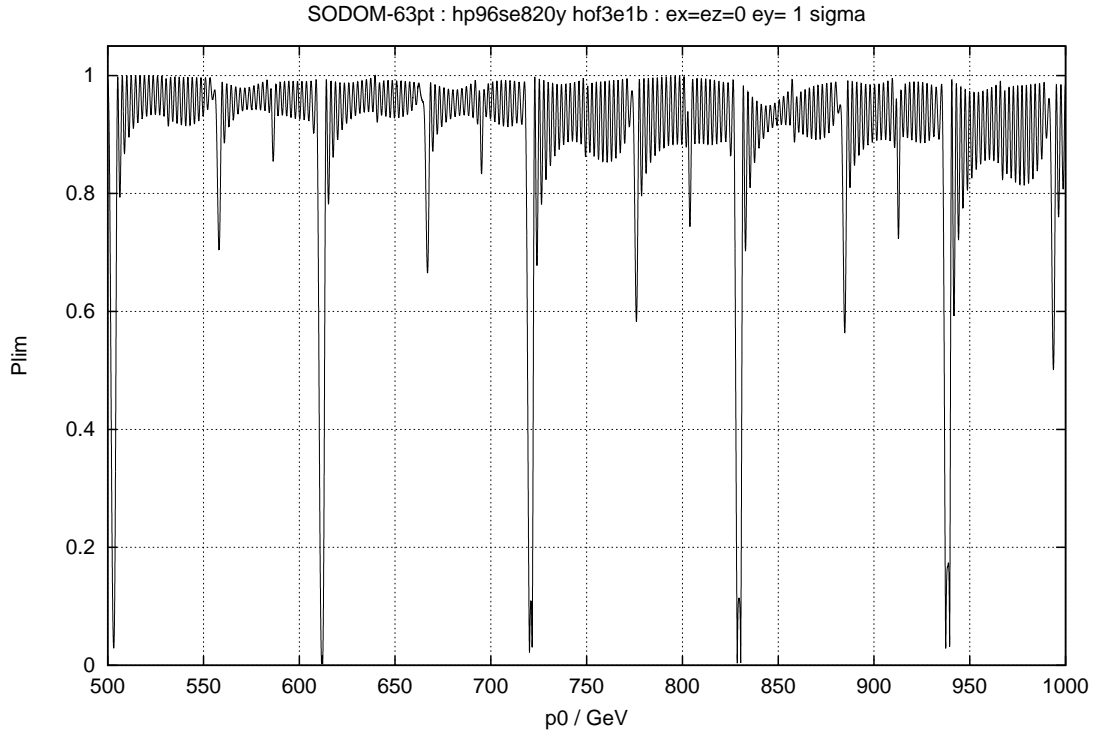

Figure 3.2: P_{lim} from 500 to 1000 GeV/c in HERA-p with flattening snakes and four additional filtered snakes for a vertical invariant amplitude of 4π mm·mrad (1σ) (top) and 16π mm·mrad (2σ) (bottom)

respectively corresponding to ‘ 1σ ’ in all three modes. A representative acceleration rate of 13keV per turn was used. The acceleration was simulated within the SPRINT program and each spin was set initially parallel to the \vec{n} -axis corresponding to the position of the particle in phase space. In spite of the fact that all three modes of orbital motion are involved,

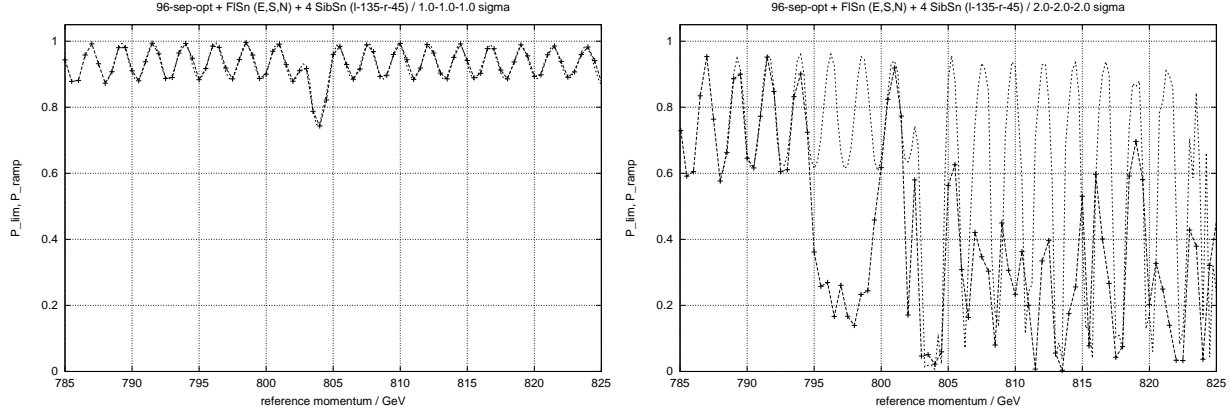

Figure 3.3: P_{lim} and P_{ramp} from 785GeV/c to 825GeV/c in HERA-p with flattening snakes and four additional filtered snakes for invariant amplitudes of $1\sigma, 1\sigma, 1\sigma$ (left) and $2\sigma, 2\sigma, 2\sigma$ (right).

the ramped polarization in figure 3.3 (left) is very similar to the P_{lim} , indicating that for particles inside 1σ in all three modes, the acceleration rate is sufficiently adiabatic and that the horizontal and longitudinal motions have little effect on the polarization. In fact although no plots are shown here, for these amplitudes P_{ramp} is almost indistinguishable from P_{lim} over the whole range from 40GeV/c to 820GeV/c. Similar results for the robustness of P_{ramp} were obtained in [5]. However only about 6 percent of the beam is contained within that boundary so that acceleration at larger amplitudes must be investigated.

Figure 3.2 (bottom) shows the dependence of P_{lim} on momentum for the same conditions as in figure 3.2 (top) except that the particles are on the 2σ vertical ellipse. Now the variation of P_{lim} with energy is much more prominent and, as expected at larger amplitude, the RRS’s are stronger. At the highest energy the equilibrium polarization would not exceed about 93 percent. The outcome of accelerating for a small range around 805GeV/c for particles at 2σ in all three planes is shown in figure 3.3 (right) where we see that the polarization is lost above 795GeV/c. We are thus led to investigate spin stability with an eight snake scheme. However, experience has shown that eight snake schemes are not necessarily better than filtered four snake schemes. So the eight snake schemes must be selected by filtering too.

3.2.3 Filtering with eight snakes

In the following we show a series of comparisons of P_{lim} and the polarization P_{ramp} surviving after acceleration for a filtered eight snake scheme. Beginning in the East, the orientations of the snake axes are as follows: 90, 90, -45, 0, 0, 0, +45 and 90 degrees respectively. The conditions are given in the figure captions. Comparison of figures 3.4 (left) and 3.3 (left) shows that, as expected, eight filtered snakes do a better job of suppressing variations of the polarization during acceleration than four such snakes. However, figure 3.4 (right) shows

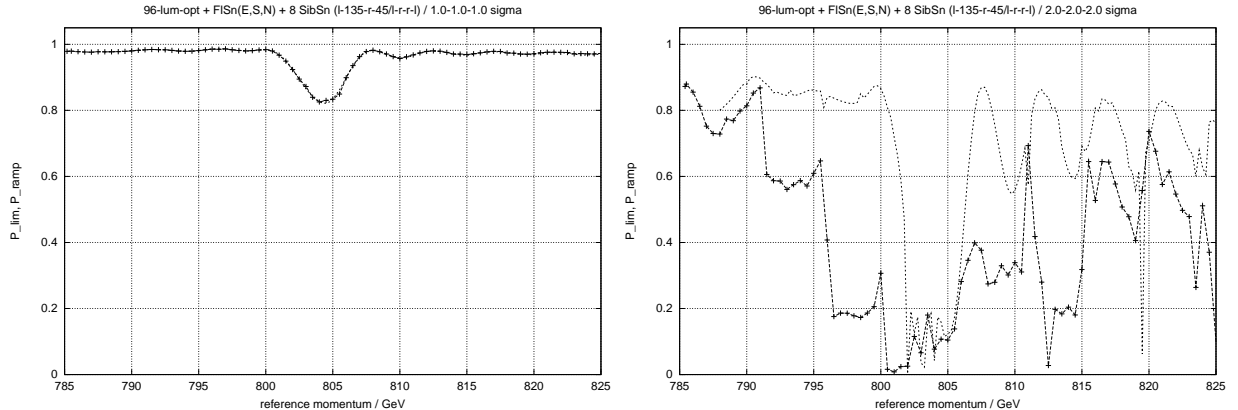

Figure 3.4: P_{lim} and P_{ramp} from 785 to 825 GeV/c in HERA-p with flattening snakes and eight additional filtered snakes for an invariant amplitude of 1σ (left) and 2σ (right) in all three planes.

that at 2σ in each plane, and with eight filtered snakes, the RRS near 805 GeV/c is still very strong and that polarization cannot be maintained when accelerating through that region. In contrast, figure 3.5 (top) demonstrates that for particles executing only vertical motion on the 2σ ellipse, eight filtered snakes are perfectly adequate for maintaining polarization during acceleration through the RRS at 805 GeV/c. So the strong depolarization seen in figure 3.4 (right) is due in some way to the additional effects of horizontal and longitudinal motion. It is apparent from figure 3.5 (bottom, left) that energy oscillations on the (1σ) longitudinal ellipse cause little disturbance beyond that due to vertical motion on the 2σ ellipse. However on moving out to the 2σ longitudinal ellipse (figure 3.5 (bottom, right)) strong additional RRS's appear. Although polarization can be maintained on acceleration through the RRS at 805 GeV/c, it is then lost at 810 GeV/c. What about the effects of horizontal betatron oscillations? Figure 3.6 (top, left) shows that for 1σ vertical motion, additional 2σ horizontal motion has some effect but that it is not very pronounced. But for 2σ vertical motion and additionally 1σ horizontal motion (figure 3.6 (top, right)), or additionally 1σ horizontal and 1σ longitudinal motion (figure 3.6 (bottom, left)) or additionally 2σ horizontal motion (figure 3.6 (bottom, right)) very little polarization survives the RRS at 805 GeV/c.

The results presented above have shown that for a perfectly aligned HERA and for pure vertical betatron motion, a snake angle configuration can be found by filtering for which residual resonance effects are so weak that almost no polarization is lost during acceleration through them. However the snake angle configuration needed is not very intuitive. In the following sections we analyse the reasons for this.

From figures 3.5 and 3.6 it is clear that the effects of horizontal and longitudinal motion cannot be ignored. This is no surprise since rotations around different axes do not commute so that spin rotations due to vertical, horizontal and longitudinal motions are not independent and the resonance spectrum becomes richer. Naturally, at high energy noncommutation effects can be particularly pronounced. However, other simulations show that for a perfectly aligned HERA and after a careful choice of betatron tunes, acceleration up to 820 GeV/c without significant loss of polarization *is* possible for particles within the 2σ , 2σ , 2σ torus. These results will be presented elsewhere [7]. Note that orbital coupling, nonlinear fields or

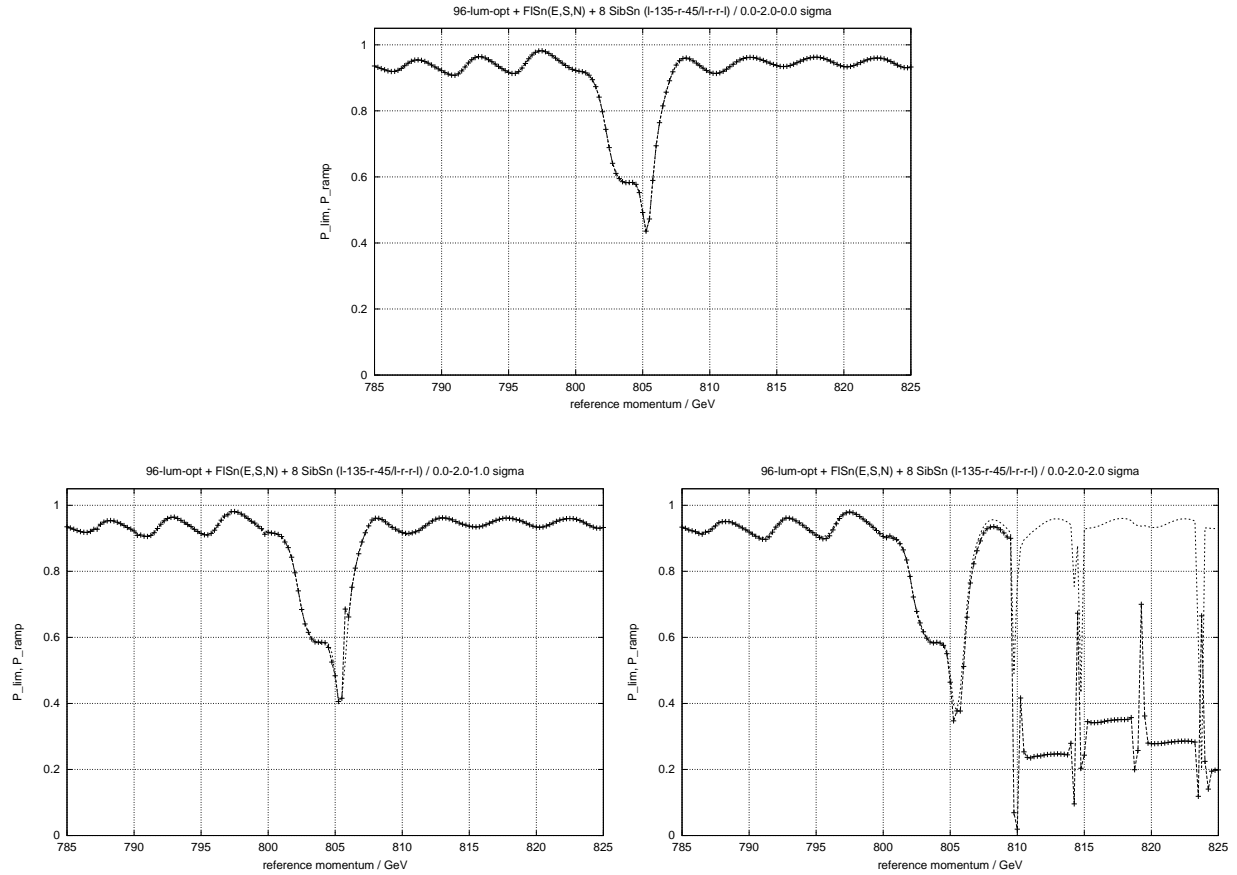

Figure 3.5: P_{lim} and P_{ramp} from 785 to 825 GeV/c in HERA-p with flattening snakes and eight additional filtered snakes for: (top) an invariant vertical amplitude of 2σ ; (bottom, left) a vertical amplitude of 2σ together with a longitudinal amplitude of 1σ ; (bottom, right) a vertical amplitude of 2σ together with a longitudinal amplitude of 2σ .

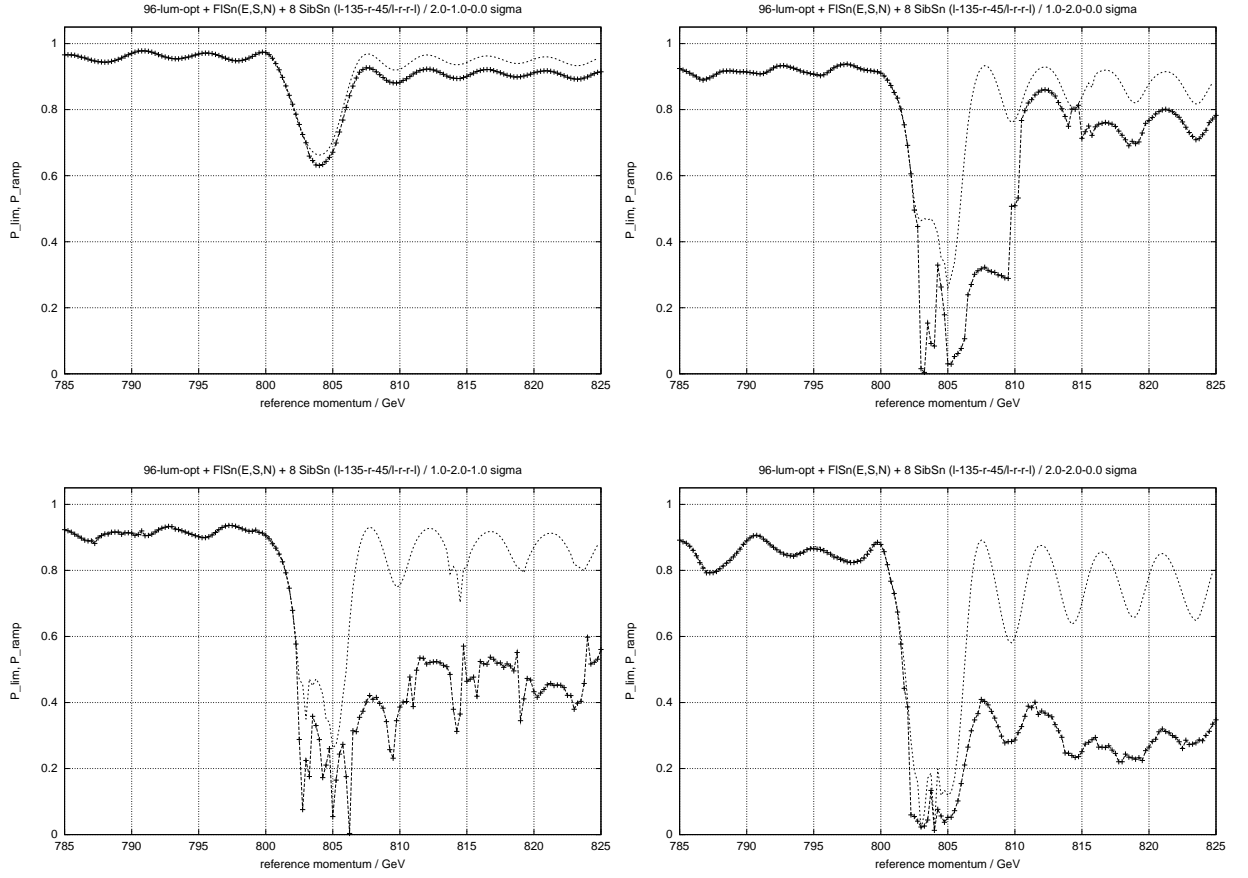

Figure 3.6: P_{lim} and P_{ramp} from 785 to 825 GeV/c in HERA-p with flattening snakes and eight additional filtered snakes for: (top, left) a horizontal amplitude of 2σ and a 1σ vertical amplitude; (top, right) a horizontal amplitude of 1σ and a 2σ vertical amplitude; (bottom, left) a horizontal amplitude of 1σ , a 2σ vertical amplitude and a 1σ longitudinal amplitude; (bottom, right) a horizontal amplitude of 2σ and a 2σ vertical amplitude.

nonlinear motion are not prerequisites for the occurrence of high order resonances. Moreover, as is clear from the results presented here, at very high energy the rule of thumb [8], that polarization can be preserved if the resonance strength is less than $N_s/5$ (where N_s is the number of snakes), provides little guidance on its own.

Acknowledgement

We thank N. Golubeva and V. Balandin for useful discussions and extensive computations.

References

- [1] G. H. Hoffstätter. Polarized protons in HERA. DESY Report 96-05, 1996.
- [2] V. A. Anferov. Spin transparent interaction regions for HERA. *Nuclear Instruments and Methods in Physics Research*, A398(2-3):423–425, 1997.
- [3] D. P. Barber. Prospects for polarized protons at HERA. *The Spin Structure of the Nucleon*, a conference at Erice in 1995. World Scientific, April 1998. 13
- [4] K. Heinemann and G. H. Hoffstätter. A tracking algorithm for the stable spin polarization field in storage rings using stroboscopic averaging. *Physical Review E*, 54:4240–4255, November 1996. DESY Report 96–078, 1996.
- [5] V. Balandin, N. Golubeva, and D. P. Barber. Studies of the behaviour of proton spin motion in HERA-p at high energies. Part II. Acceleration of polarized protons in HERA. DESY report M-98-03, 1998.
- [6] K. Yokoya. An algorithm for calculating the spin tune in circular accelerators. DESY report 99-006, 1999.
- [7] M. Vogt, Thesis in preparation.
- [8] S. Y. Lee and E. D. Courant, *Physical Review*, D41:292–302, 1997.

4 Spin matching

Spin-orbit resonances in high energy accelerators arise when the electromagnetic fields on synchro-betatron trajectories cause disturbances to the spin motion which build up coherently from turn to turn. These disturbances are described in first order theory by the spin-orbit coupling integrals to be discussed next. The integrals are especially big at first order resonances and when the spin disturbances from each FODO cell add up coherently [1].

In a perfectly flat ring, an initially vertical spin of a particle traveling on the closed orbit remains vertical during the particle motion. On a vertical betatron trajectory the particle traverses horizontal fields in quadrupoles and the spin no longer remains vertical. This disturbance of spin motion due to the vertical betatron motion is described in first order theory by the spin-orbit coupling integrals [2, 3] which take the form

$$I_y^\pm = \int_{l_0}^{l_0+L} k_y e^{i(-\Psi \pm \Psi_y)} dl . \quad (4.1)$$

where $k_y = k\sqrt{\beta_y}$ whereby k is the quadrupole strength and β_y is the vertical beta function; Ψ is the phase advance of the spin rotation around the vertical and Ψ_y is the vertical betatron phase. The integral is evaluated over the ring circumference L . Spin-orbit coupling integrals describing spin disturbances due to horizontal betatron motion and synchrotron motion can also be defined. But in a flat ring, \vec{n}_0 is vertical so that these extra integrals vanish.

Thus in a first order approximation we only need the integrals I_y^\pm and they yield the following important information: if the spin-orbit coupling integrals I_y^\pm vanish, all initially vertical spins are again vertical after one turn, although they have traveled along different betatron trajectories. The ring is then said to be spin matched or spin transparent when viewed from l_0 . In general the spin-orbit coupling integrals depend strongly on the beam energy and on the chosen optic. However, as expected and as implied by the numerical results presented earlier, the inclusion of Siberian Snakes can significantly weaken such dependencies. It is then interesting to see if snake configurations can be chosen by analytical means for which the spin-orbit coupling integrals can be made to vanish. We call this version of spin matching ‘snake matching’. In large rings with many snakes, snake matching can be achieved for separate sections of the ring [2]. In HERA-p with a maximum of eight snakes this cannot be done in general. However, HERA-p has an approximate four-fold symmetry and as we will see later, in rings with exact four-fold symmetry all spin orbit integrals can be canceled completely even with only eight snakes. In fact, it is even possible to find snake axis orientations for these eight snakes which are independent of energy and nevertheless cancel all the spin orbit coupling integrals.

4.1 Spin matching with Type III snakes

For a ring with superperiod four, the one turn spin integral starting at $l_0 = 0$ is

$$I_y^\pm = I_{\frac{1}{4}}^\pm (1 + e^{i(\nu \pm Q)/4} + e^{i2(\nu \pm Q)/4} + e^{i3(\nu \pm Q)/4}) \quad (4.2)$$

where $I_{\frac{1}{4}}^{\pm} = \int_0^{L/4} k_y e^{i(-\Psi \pm \Psi_y)} dl$ and where $\nu = -\Psi(L)$ and Q are the spin phase advance and the orbital phase advance during one turn. The sign convention is chosen so that $\nu = 2\pi G\gamma$ where G is the gyromagnetic anomaly and γ is the Lorentz factor. Spin transparency requires that I_y^+ as well as I_y^- vanish. This requires that the bracket in equation (4.2) vanishes which implies that $Q \stackrel{\circ}{=} \pi$ where the symbol $\stackrel{\circ}{=}$ indicates equivalence modulo 2π . However storage rings are never operated at such an orbital resonance so that the four-fold repetitive symmetry cannot be employed to impose spin transparency at any energy.

Type III snakes are devices which rotate spins around the vertical direction by some angle ϕ , while leaving the betatron motion unaltered. They can be used to manipulate the spin phase advance between quadrants. The spin disturbances of one quadrant can be made to cancel against the disturbances of another quadrant by choosing an appropriate spin phase advance between these quadrants. There are exactly three ways to arrange that the spin disturbances cancel during one turn. They are indicated in figure 4.1.

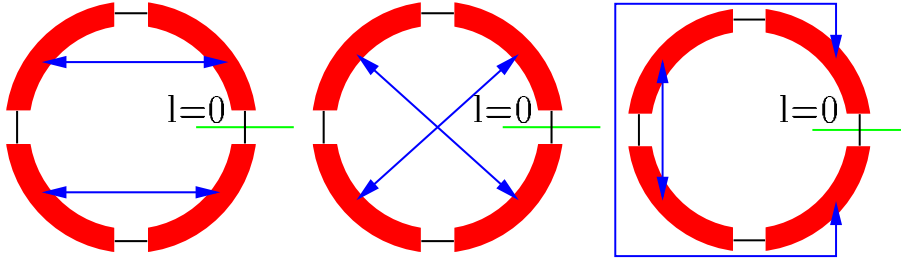

Figure 4.1: The three ways in which the depolarizing effects of the quadrants of a ring with superperiod four can cancel each other. The arrows indicate which quadrants have canceled against each other after one turn starting at $l = 0$.

When the Type III snake at $l = j\frac{L}{4}$, $j \in \{1 \dots 4\}$ has the rotation angle ϕ_j , then the spin-orbit coupling integrals are

$$I^{\pm} = I_{\frac{1}{4}}^{\pm} \{ 1 + e^{i[(\nu \pm Q)/4 - \phi_1]} + e^{i[2(\nu \pm Q)/4 - \phi_1 - \phi_2]} + e^{i[3(\nu \pm Q)/4 - \phi_1 - \phi_2 - \phi_3]} \}. \quad (4.3)$$

For a spin match, the bracket on the right hand side has to vanish for ‘+’ and for ‘-’. A sum of four complex numbers with unit modulus can only vanish when it consists of two pairs of numbers which cancel each other. The three possibilities of cancellation are demonstrated in figure 4.1 and are described by the following three sets of equations:

1. $(\nu \pm Q)/4 - \phi_1 \stackrel{\circ}{=} \pi$ and $(\nu \pm Q)/4 - \phi_3 \stackrel{\circ}{=} \pi$,
2. $2(\nu \pm Q)/4 - \phi_1 - \phi_2 \stackrel{\circ}{=} \pi$ and $\phi_3 \stackrel{\circ}{=} \phi_1$,
3. $3(\nu \pm Q)/4 - \phi_1 - \phi_2 - \phi_3 \stackrel{\circ}{=} \pi$ and $(\nu \pm Q)/4 - \phi_2 \stackrel{\circ}{=} \pi$.

To spin match, one of these three conditions has to hold for ‘+’, to make I^+ vanish, and another of the conditions has to hold for ‘-’, to make I^- vanish. I^+ and I^- cannot vanish simultaneously within one of the three conditions, since this would lead to a restriction on the allowed orbital phase advance Q . Canceling one integral by condition 3 turns out

to be incompatible with canceling the other integral by condition 1 or 2. When canceling I^+ by condition 1 and I^- by condition 2, the requirements are compatible and lead to $\phi_1 \stackrel{\circ}{=} \phi_3 \stackrel{\circ}{=} \pi + (\nu + Q)/4$ and $\phi_2 \stackrel{\circ}{=} (\nu - 3Q)/4$.

The rotation angle ϕ_4 of the Type III snake at $l_0 = 0$ is chosen in such a way that the spin tune of the ring is not changed by the snakes: $\phi_1 + \phi_2 + \phi_3 + \phi_4 \stackrel{\circ}{=} 0$. With $\Sigma = (\nu + Q)/4$ the required rotation angles are

$$\phi_1 \stackrel{\circ}{=} \phi_3 \stackrel{\circ}{=} \Sigma + \pi, \quad \phi_2 \stackrel{\circ}{=} \Sigma - Q, \quad \phi_4 \stackrel{\circ}{=} \Sigma - \nu. \quad (4.4)$$

A change in sign of Q cancels I^+ due to condition 2 and I^- due to condition 1. There are therefore exactly two possibilities of making a ring with superperiod four spin transparent by means of four Type III snakes. These possibilities are shown in figure 4.2 where the longitudinal direction of particle motion is chosen to be clockwise. In passing we note that

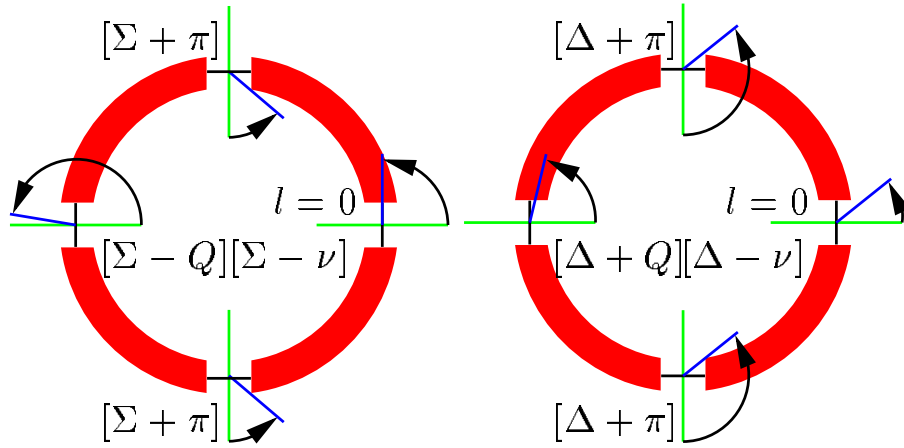

Figure 4.2: The two only ways to spin match a ring with superperiod four by four Type III snakes. The number between 0 and 2π which equals x modulo 2π is written as $[x]$, $\Sigma = (\nu + Q)/4$, $\Delta = (\nu - Q)/4$.

mirror symmetric arcs present no advantages for spin matching a ring by this method.

4.2 Energy independent spin matching

Spin matching with four Type III snakes has the great disadvantage that the rotation angles change with the energy dependent spin phase advance ν and thus have to be ramped in order to spin match at each energy. Furthermore, particles with nonzero synchrotron amplitude execute energy oscillations so that for such particles a spin match can never be achieved.

We now consider what can be achieved with snakes whose rotation axes lie in the horizontal plane ('horizontal snakes').

Siberian Snakes [4] other than Type III rotate all spins by π around their horizontal rotation axes. If the axis is at an angle $\alpha/2$ with respect to the radial direction in the longitudinal backward direction, a 'horizontal' snake is said to have a snake angle of α [2]. Its effect on spins is equivalent to that of a snake with a radial axis followed immediately by

a Type III snake with a rotation angle α . Therefore also snakes with horizontal axes can be used to manipulate the spin phase advance between parts of the ring.

We now assume that there are n horizontal snakes in the ring. The snake angle of the j -th snake is α_j . Furthermore we assume that these snakes have been chosen in such a way that the \vec{n} -axis on the closed orbit, which is denoted by \vec{n}_0 and is periodic, is aligned along the vertical in all of the ring and that the spin tune on the closed orbit is $1/2$. The positions of these snakes are denoted by l_j and the advance of the spin phase beyond the j th snake is $\Psi_j(l)$ where $\Psi_j(l_j) = 0$.

For simplicity we set $l_0 = 0$, $l_{n+1} = L$, and $\alpha_0 = 0$ and denote the spin phase advance between snake j and snake $j + 1$ as Ψ_j . The orbital phase advance between snake j and snake $j + 1$ is denoted by Ψ_{yj} . Taking \vec{n}_0 to point initially vertically upwards we then obtain the spin-orbit coupling integrals [2]

$$I^\pm = \sum_{j=0}^n e^{i \sum_{k=0}^{j-1} [-(-1)^k (\alpha_k + \Psi_k) \pm \Psi_{yk}]} \int_{l_j}^{l_{j+1}} k_y e^{i [-(-1)^j (\Psi_j(l) + \alpha_j) \pm \Psi_{yj}(l)]} dl . \quad (4.5)$$

4.2.1 Four snake schemes

For a four-fold symmetric ring with a horizontal snake between each arc the spin-orbit coupling integrals (4.5) reduce to

$$I^\pm = I_{\frac{1}{4}}^\pm \{ 1 + e^{i(\alpha_1 - \alpha_2 \pm 2Q/4)} \} + (I_{\frac{1}{4}}^\mp)^* e^{i[(\nu \pm Q)/4 + \alpha_1]} \{ 1 + e^{i(-\alpha_2 + \alpha_3 \pm 2Q/4)} \} .$$

Spin transparency of the ring is therefore in general only obtained when

$$\alpha_1 - \alpha_2 \pm 2Q/4 \stackrel{\circ}{=} \pi \text{ and } -\alpha_2 + \alpha_3 \pm 2Q/4 \stackrel{\circ}{=} \pi . \quad (4.6)$$

Choosing the ‘+’ combination for one equation and the ‘−’ combination for the other implies $Q \stackrel{\circ}{=} 0$. A synchrotron is never operated with this orbital phase advance. Therefore four horizontal snakes cannot be used to eliminate all spin-orbit coupling integrals.

In passing we note that again an additional mirror symmetry does not simplify the compensation of the spin-orbit integrals.

4.2.2 Eight snake schemes

The same procedure can now be repeated with eight snakes. To do that we place four more horizontal snakes at the locations $kL/4 + \Delta l_k$, $k \in \{0, 1, 2, 3\}$, i.e. at a distance Δl_k downstream from the four snakes treated above. The complete spin phase advance of the ring is $\sum_{j=0}^7 (-1)^j (\Psi_j + \alpha_j)$ and this should be set to π independently of the energy to give a closed orbit spin tune of $1/2$. Therefore $\sum_{j=0}^7 (-1)^j \Psi_j$ must vanish at all energies so that the Δl_k must be chosen to ensure that $\Psi_j = \Psi_0$, $j \in \{1 \dots 7\}$. From equation (4.5) with $n = 8$ and with $I_0^\pm = \int_0^{\Delta l} k_y e^{i(-\Psi \pm \Psi_y)} dl$ and $I_1^\pm = \int_{\Delta l}^{\frac{L}{4}} k_y e^{i(\Psi \pm \Psi_y)} dl$, the spin-orbit coupling integrals are

$$I^\pm = I_0^\pm \{ 1 + e^{i[\alpha_1 - \alpha_2 \pm (\Psi_{y0} + \Psi_{y1})]} + \dots + e^{i[\alpha_1 - \alpha_2 \mp \dots - \alpha_{n-2} \pm (\Psi_{y0} + \dots + \Psi_{yn-3})]} \} \\ + I_1^\pm e^{i(-\Psi_0 + \alpha_1 \pm \Psi_{y0})} \{ 1 + e^{i[-\alpha_2 + \alpha_3 \pm (\Psi_{y1} + \Psi_{y2})]} + \dots + e^{i[-\alpha_2 + \alpha_3 \pm \dots + \alpha_{n-1} \pm (\Psi_{y1} + \dots + \Psi_{yn-2})]} \} .$$

where most of the spin phases $\Psi_j = \Psi_0$ have canceled. In terms of the difference angles $\Delta_{jk} = \alpha_j - \alpha_k$, spin matching the ring therefore requires

$$1 + e^{i(\pm Q/4 + \Delta_{12})} + e^{i(\pm 2Q/4 + \Delta_{12} + \Delta_{34})} + e^{i(\pm 3Q/4 + \Delta_{12} + \Delta_{34} + \Delta_{56})} = 0, \quad (4.7)$$

$$1 + e^{i(\pm Q/4 - \Delta_{23})} + e^{i(\pm 2Q/4 - \Delta_{23} - \Delta_{45})} + e^{i(\pm 3Q/4 - \Delta_{23} - \Delta_{45} - \Delta_{67})} = 0. \quad (4.8)$$

These equations have the same structure as the matching conditions of equations (4.3) and we can therefore use the relations (4.4) to obtain the following two ways to satisfy equation (4.7):

$$\Delta_{12} \stackrel{\circ}{=} \Delta_{56} \stackrel{\circ}{=} \pi - Q/4, \quad \Delta_{34} \stackrel{\circ}{=} 3Q/4, \quad (4.9)$$

$$\Delta_{12} \stackrel{\circ}{=} \Delta_{56} \stackrel{\circ}{=} \pi + Q/4, \quad \Delta_{34} \stackrel{\circ}{=} -3Q/4. \quad (4.10)$$

There are also exactly two ways to solve equation (4.8),

$$\Delta_{23} \stackrel{\circ}{=} \Delta_{67} \stackrel{\circ}{=} \pi + Q/4, \quad \Delta_{45} \stackrel{\circ}{=} -3Q/4, \quad (4.11)$$

$$\Delta_{23} \stackrel{\circ}{=} \Delta_{67} \stackrel{\circ}{=} \pi - Q/4, \quad \Delta_{45} \stackrel{\circ}{=} 3Q/4. \quad (4.12)$$

There are now four ways to spin match the ring; these are obtained by combining the equations (4.9)&(4.11), (4.9)&(4.12), (4.10)&(4.11) or (4.10)&(4.12), where the last two possibilities result from the first two by reversing the sign of Q .

Since only differences in the snake angles appear, one of the angles can be chosen arbitrarily. All other snake angles are then fixed. Combining the equations (4.9) and (4.11) and choosing $\alpha_1 = 0$ leads to

$$\begin{aligned} \alpha_1 &\stackrel{\circ}{=} \alpha_3 \stackrel{\circ}{=} \alpha_5 \stackrel{\circ}{=} \alpha_7 \stackrel{\circ}{=} 0, & \alpha_2 &\stackrel{\circ}{=} \alpha_6 \stackrel{\circ}{=} \pi + Q/4, \\ \alpha_4 &\stackrel{\circ}{=} -3Q/4, & \alpha_8 &\stackrel{\circ}{=} \pi + Q/4. \end{aligned} \quad (4.13)$$

Combining the equations (4.9) and (4.12) and choosing $\alpha_1 = -Q/2$ leads to

$$\begin{aligned} \alpha_1 &\stackrel{\circ}{=} -2Q/4, & \alpha_2 &\stackrel{\circ}{=} \alpha_6 \stackrel{\circ}{=} \pi - Q/4, \\ \alpha_3 &\stackrel{\circ}{=} \alpha_5 \stackrel{\circ}{=} \alpha_7 \stackrel{\circ}{=} 0, & \alpha_4 &\stackrel{\circ}{=} -3Q/4, & \alpha_8 &\stackrel{\circ}{=} \pi + 3Q/4. \end{aligned} \quad (4.14)$$

These snake schemes are shown in figure 4.3 where advantage has been taken of the fact that the angle $\alpha/2$ between the radial direction and the rotation axis only needs to be known modulo π .

Here it is very important to note that the snake angles are independent of $\nu = 2\pi G\gamma$ and therefore that a spin match has been achieved for all energies for the chosen Q .

At high energies, for example at 820GeV in HERA-p, the polarization limit P_{lim} determined by the \vec{n} -axis can be problematically small [5]. To first order the proposed spin matching increases the polarization limit to 100% since all spins return to the vertical on all betatron orbits as long as no misalignments and deviations from the four-fold symmetry are present in the ring.

Note that the set of snake angles depicted in figure 4.3 is somewhat unconventional. Naturally this set of snake angles differs from that obtained by filtering as described in section 3.2.1 but nevertheless this analysis indicates why filtering will select such exotic sets of snake angles. Of course a similar kind of analysis could be used to explain why some snake schemes can be particularly bad. The fact that particularly bad snake schemes can be envisaged is another reason to treat with caution the rule of thumb [6] mentioned at the end of the previous section.

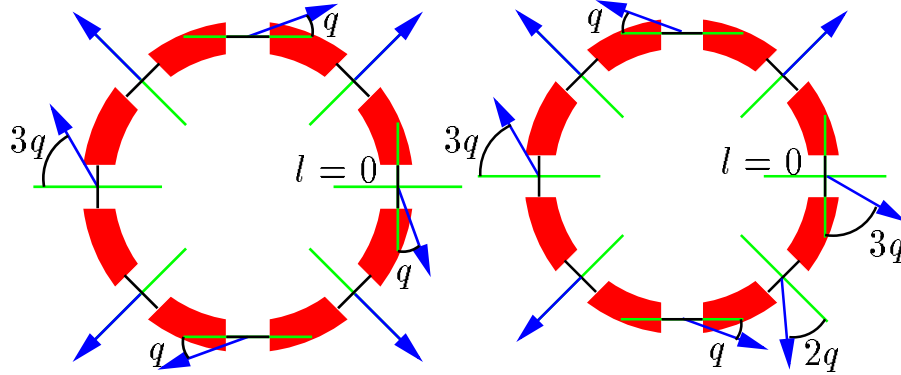

Figure 4.3: Two of the four possible ways to spin match a ring with superperiod four using eight horizontal snakes. q is $Q/8$ modulo π and describes the angle between the radial direction and the snake axis. The other two ways are obtained by reversing the sign of Q . Note that the snake angles are independent of $\nu = 2\pi G\gamma$ and thus of energy.

References

- [1] E. D. Courant, S. Y. Lee, and S. Tepikian. In *Proceedings of the Workshop on Polarized beams at SSC*, volume 145 of *AIP Conference Proceedings*, page 174, New York, 1985. AIP.
- [2] K. Steffen. Strong spin matching with and without snakes, a scheme for preserving polarization in large ring accelerators. *Particle Accelerators*, 24:45, 1988 DESY report 88-068, 1988.
- [3] D. P. Barber and G. Ripken. *Handbook of Accelerator Physics and Engineering*. Eds. A.W. Chao and M. Tigner. World Scientific, 1999. In preparation.
- [4] Ya. S. Derbenev and A. M. Kondratenko. *Sov. Phys. Doklady*, 20:562, 1976.
- [5] D. P. Barber, K. Heinemann, G. H. Hoffstätter, and M. Vogt. Calculations of the equilibrium spin distribution for protons at high energy in HERA. In *Proceedings of SPIN96*, Amsterdam, September 1996.
- [6] S. Y. Lee and E. D. Courant, *Physical Review*, D41:292-302, 1997.

5 Polarization in HERA

A 920 GeV polarized proton beam together with the existing 27.5 GeV polarized electron or positron beam could provide a unique tool to study spin effects in high energy physics. To make this polarized beam program practical, one must insure that each beam has a high intensity and a high degree of polarization. A polarized positron beam has been routinely stored in HERA with about 60% polarization. Acceleration of a polarized proton beam in HERA has been jointly studied by the SPIN Collaboration and the DESY Polarization team [1]. All problems during the polarized protons' acceleration at low energies were found to have straightforward solutions using existing techniques. Accelerating polarized protons to 920 GeV in HERA appears to be more challenging. Below we will discuss several options for maintaining the proton beam polarization in HERA.

5.1 Cost effective solution with four Siberian snakes

The lattice of the 920 GeV HERA proton ring has approximate four-fold symmetry and four straight sections as shown in Fig. 5.1. In view of HERA's four-fold symmetry it seems natural to incorporate four snakes in the HERA ring [2].

However, as shown in a DESY report [3], the vertical bends near the North and South experimental areas certainly make HERA into a non-flat ring and interfere with any standard snake configurations suitable for a flat ring. Therefore, we suggest installing four additional snakes [4] with radial axes in the North and South straight sections as shown in Fig. 5.1. These snakes, specially placed as shown in Fig. 5.2, would compensate the vertical bends' effect on the spin and make these interaction regions spin transparent. To emphasize their purpose, we call these snakes "flattening snakes". These flattening snakes not only compensate the spin perturbation from the vertical bends in the HERA ring but also return the stable spin direction to the energy independent vertical orientation. This enables one to apply regular Siberian snakes to overcome depolarizing resonances in the "effectively" flat HERA ring. All four flattening snakes together with four superconducting regular Siberian snakes can be installed into the existing free spaces in the four long straight sections of the HERA ring. Such a snake configuration does not require any additional modifications of the accelerator lattice; it seems to be the most attractive and cost efficient solution for the polarized proton beam in HERA.

So far we considered how many Siberian snakes can be easily installed in HERA. Next we consider how many snake are required to preserve the beam polarization. The maximum strength of the spin depolarizing resonances determines how many snakes are needed in an accelerator. A simple spin stability criteria could be obtained from the condition that the beam is not depolarized between the two consecutive snakes. Assuming N_s snakes evenly distributed around the ring, the angle of spin perturbation at a resonance of strength ε is

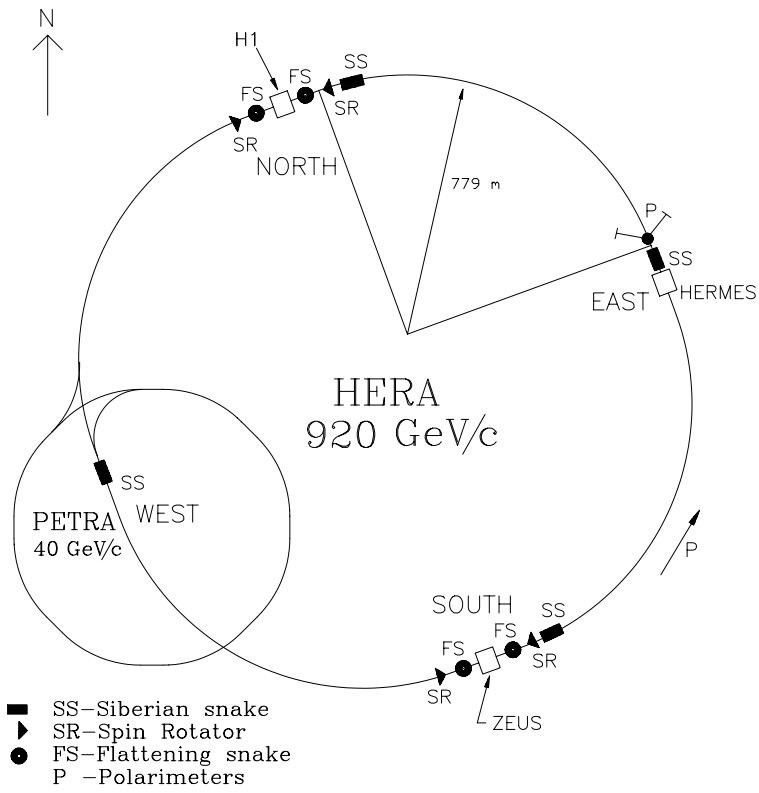

Figure 5.1: Layout of the polarized beam hardware in the 920 GeV/c HERA proton ring.

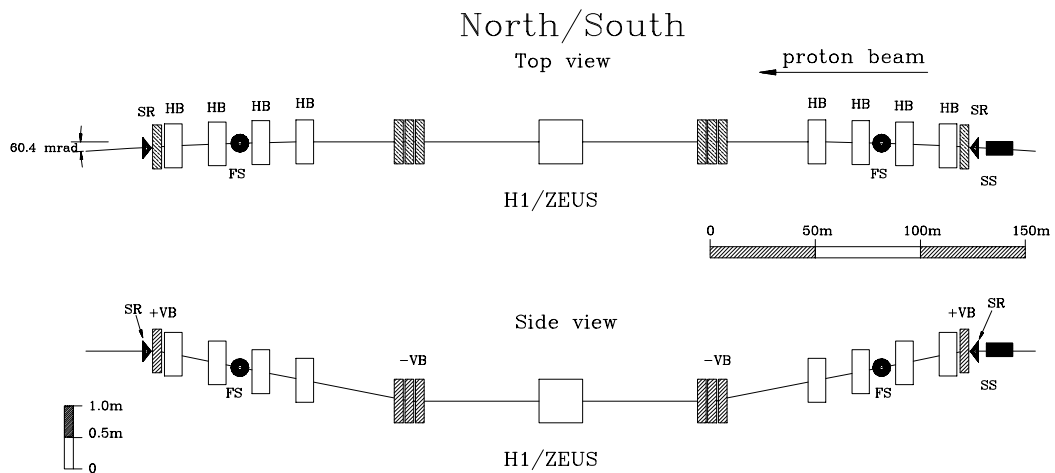

Figure 5.2: Layout of the flattening snakes, spin rotators and regular Siberian snakes around the collider detectors.

proportional to the azimuthal distance between the snakes

$$\delta = \varepsilon \cdot \frac{2\pi}{N_s} . \quad (5.1)$$

The vertical spin precession between the snakes remains stable as long as the angle of spin perturbation $\delta < \pi/2$; otherwise, initially vertical spin would be brought into the unstable horizontal orientation. Finally, since the strong intrinsic and imperfection depolarizing resonances occur at almost the same energies, the spin stability criteria could be written

$$\varepsilon_{int} + \varepsilon_{imp} < N_s/4 . \quad (5.2)$$

A more rigorous study [5] found similar conditions for the spin stability in a ring with N_s snakes. Assuming the betatron tunes are chosen away from any “strong” snake resonances, the maximum strength of the tolerable intrinsic and imperfection depolarizing resonances is given by

$$\varepsilon_{int} < N_s/5 , \text{ while } \varepsilon_{imp} < N_s/10 . \quad (5.3)$$

Thus, for four snakes, the HERA intrinsic depolarizing resonance strengths should not exceed 0.8, while the strength of imperfection resonances in HERA should be below 0.4.

We estimated the strengths of the depolarizing resonances for a flat HERA using the DEPOL code [6]. The strengths of the intrinsic depolarizing resonances in HERA was calculated assuming the existing 25π mm-mrad polarized beam emittance. The results are plotted against the beam energy in Fig. 5.3. The maximum intrinsic resonance strength is about 1.72, which is more than twice larger than the upper limit for the four snakes. The strengths of the imperfection resonance in HERA were calculated assuming the existing rms vertical orbit error of 2 mm; these resonances are plotted in Fig. 5.4. The maximum imperfection resonance strength is about 3.7, which is also far above the upper limit for spin stability. Therefore, four snakes would not be adequate for maintaining the beam polarization in HERA with the present quality of the proton beam. The DESY Polarization team suggested many ways to further study this difficulty which they first discovered using their very detailed spin tracking and stroboscopic averaging program SPRINT [7].

In order to apply inexpensive configuration of four snakes in HERA, one should consider various corrections techniques to reduce the vertical rms orbit error to perhaps 0.2 mm and the vertical beam emittance to perhaps 5π mm-mrad. Simple scaling laws suggest that these corrections would allow the acceleration of polarized protons at HERA to 920 GeV; the ε_{int}^{max} would be reduced by about $\sqrt{5}$ to about 0.76 while the ε_{imp}^{max} would be reduced by about 10 to 0.37. For these values of $\varepsilon_{imp}^{max} = 0.37$ and $\varepsilon_{int}^{max} = 0.76$, the spin tracking programs found spin stability at 920 GeV [10] since the snakes would then dominate the spin motion according to Eq.(1). The results of the spin tracking during the acceleration of the polarized proton beam to 920 GeV are shown in Fig. 5.5.

The required improvement of the proton beam emittance could be obtained with a high-energy electron cooling at PETRA [8], which has been considered as a long term option for the HERA Luminosity Upgrade [9]. The beam emittance could be also reduced with a 200 MeV injector synchrotron into the DESYIII [11]. Note that any effort in improving the proton beam quality in HERA would be beneficial for both polarized and unpolarized

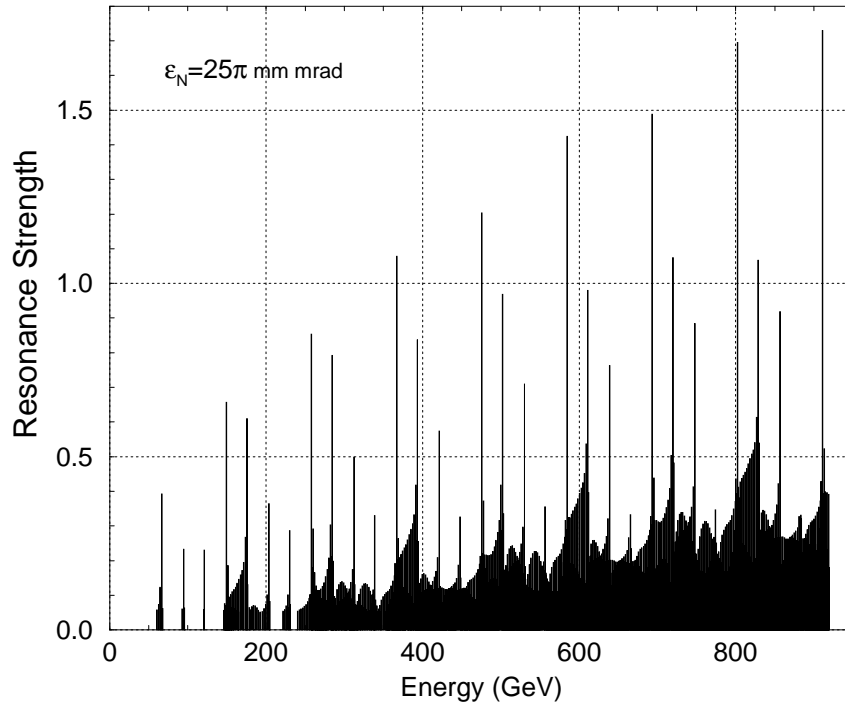

Figure 5.3: Strength of the intrinsic depolarizing resonances in a flat HERA calculated assuming a 25π mm-mrad polarized beam emittance.

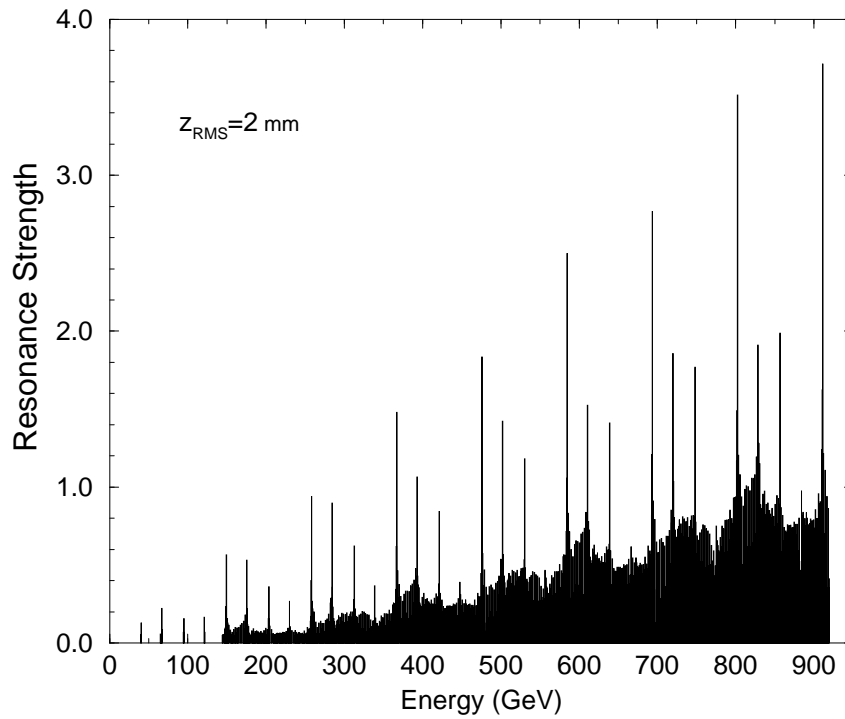

Figure 5.4: Strength of the imperfection depolarizing resonances in a flat HERA calculated assuming a 2 mm rms vertical closed orbit error for polarized beam.

beams. This approach might be more practical than modifying the accelerator lattice to fit additional snakes.

The long term spin stability in the presence of Siberian snakes is sensitive to high-order snake resonances [1]. These snake resonances occur when a combination of integer multiples of the vertical ν_y and horizontal ν_x betatron tunes is equal to a half-integer spin tune

$$\frac{1}{2} = \nu_{sp} = k \pm m\nu_y \pm n\nu_x . \quad (5.4)$$

The effect of the snake resonances can accumulate over many turns even in the presence of Siberian snakes; these resonances become very important in colliders and storage rings, where the beam life time is several hours. A second-order snake resonance was recently observed and studied at IUCF [13]. Clearly, the choice of the betatron tunes and control of the spin tune become important. To avoid the snake resonances up to the 7th order one could set the fractional part of the vertical betatron tune near 0.145 or 0.195.

5.2 Additional snakes to improve spin stability in HERA

It appears that the four normal Siberian snakes suggested for HERA would not be able to provide adequate spin stability at 920 GeV. With the existing 25π mm-mrad emittance and 2 mm rms orbit errors, it might be necessary to install 8 Siberian snakes in HERA to overcome its rather strong depolarizing resonances. Installing additional snakes in HERA would require changes in the accelerator lattice to provide spaces for the extra snakes. This would significantly increase the total cost of the polarized proton beam. To make spaces for the additional snakes one can consider replacing some existing HERA dipoles with shorter higher fields dipoles; however, design of such high-field dipoles could be rather difficult since HERA dipoles already operate at 6 Tesla field.

An alternative could be to rearrange the existing dipoles within a FODO cell; in this case, one can obtain about 3.2 m of free space, which may be sufficient for an optimized compact Siberian snake. Our study concluded that a compact helical Siberian snake requires about 3 m of free space. An example of a compact helical snake with longitudinal axis axis of spin rotation is shown in Fig. 5.6.

Studying possible ways to increase the spin stability in HERA we have also considered two rather novel ideas of using either type-3 snakes or special bending snakes in addition to the regular Siberian snakes in HERA.

5.2.1 Type-3 snakes in HERA

Siberian snakes usually have horizontal axes of the spin rotation except for a type-3 snake, which rotates the spin around the vertical axis. While type-3 snakes do not prevent crossing of the depolarizing resonances, they could significantly reduce the amount of spin perturbation at each resonance. Installing 4 type-3 snakes in the HERA arcs in addition to the 4 regular snakes could be a possible way to reduce the strong depolarizing resonances and improve overall spin stability [14].

The strongest spin perturbation occur near the spin-orbit resonances. Therefore, to improve the spin stability in a ring with Siberian snakes one needs a method of local correction

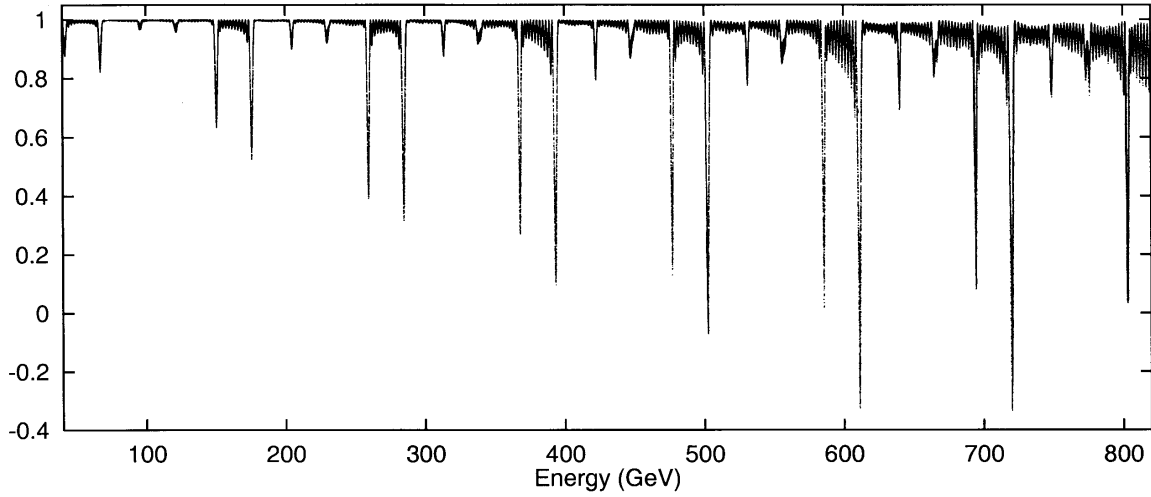

Figure 5.5: Spin tracking during polarized proton beam acceleration to 910 GeV in HERA ring equipped with 4 flattening snakes and 4 regular snakes. The polarized beam emittance was assumed 4π mm mrad in the vertical and horizontal planes.

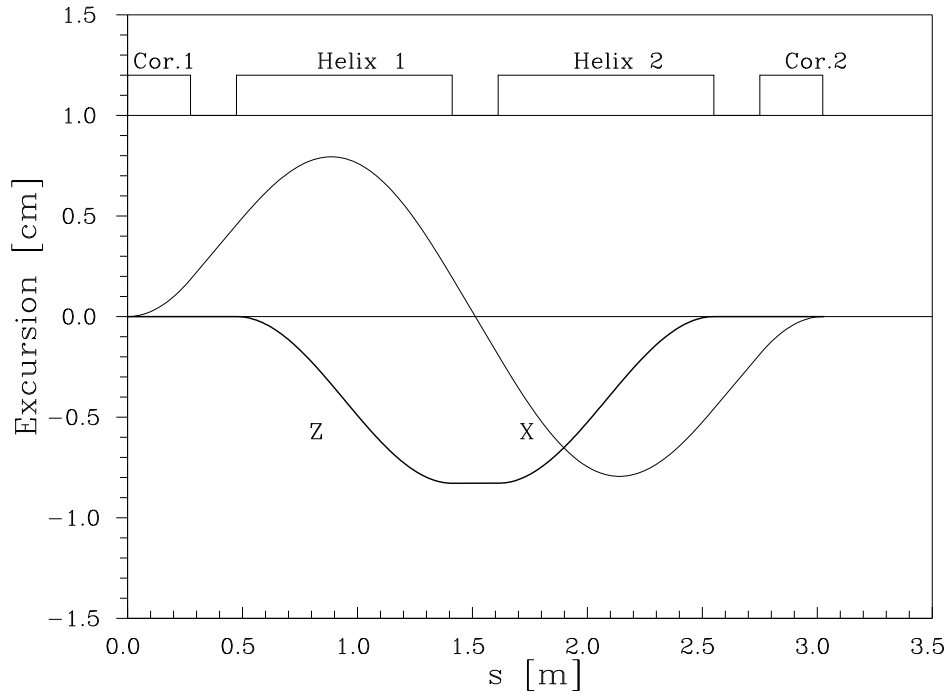

Figure 5.6: Compact helical Siberian snake design with the longitudinal axis of spin rotation.

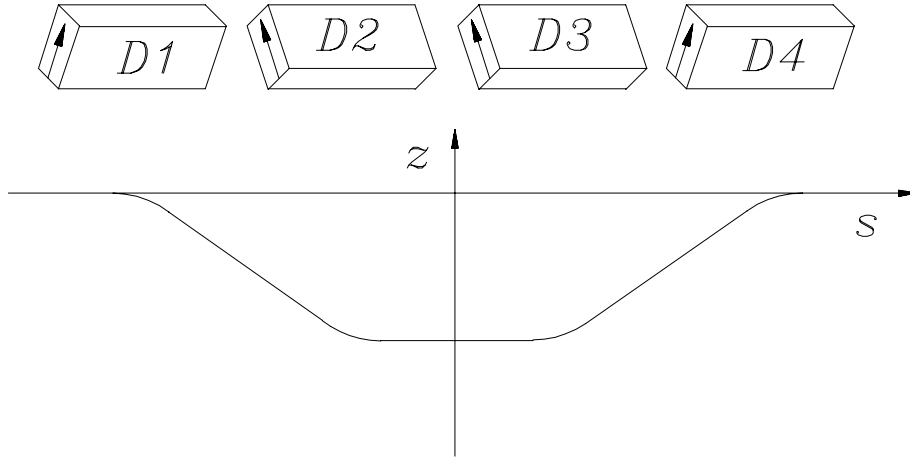

Figure 5.7: Bending Siberian snake configuration with the radial axis of spin rotation and the vertical orbit bump inside the snake.

of the spin-orbit resonances. A type-3 snake can significantly reduce the spin perturbation near the strong depolarizing resonances; thus, installing a type-3 snake between two regular Siberian snakes could improve overall spin stability.

We studied the effect of a type-3 snake in an ideal accelerator arc consisting of 24 FODO cells, which corresponds to the HERA case assuming four snakes installed in the long straight sections. By varying the position and strength of a type-3 snake in the arc, we found that a full type-3 snake should be installed after 6 cells, which is 1/4 of the arc. In this optimal configuration, the type-3 snake reduces the maximum spin perturbation in the arc by a factor of 2.

Unfortunately, the expected improvement in spin stability due to additional type-3 snakes in HERA was not confirmed by the spin tracking studies. Perhaps, the effect of type-3 snakes was reduced by the clustering of several strong depolarizing resonances in the vicinity of the main resonance. We plan to study further the effect of type-3 snakes.

5.2.2 Bending Siberian snakes

Providing free spaces for Siberian snakes does not present a problem when designing new machines. However, the existing rings usually have very little space available for the snakes installation. This is the main motivation for a snake design which could combine the required spin rotation with the function of orbit bend similar to the lattice dipoles.

A simple configuration for a symmetric spin rotator, which also provides horizontal orbit bend, was proposed in [15]. It involves four identical skew dipoles with equal vertical component of the magnetic field $B_z = B \cos \alpha$. The horizontal components of the magnetic field in the dipoles have alternate sign $B_x = \pm B \sin \alpha$; they generate a vertical bump in the beam orbit as shown in Fig. 5.7. The resulting spin rotation ψ depends on the dipole's tilt angle α and on the dipole's angle of spin rotation ϕ :

$$\cos \frac{\psi}{2} = 1 - \sin^2 \phi (1 + \cos 2\alpha) . \quad (5.5)$$

A full snake with the radial axis of spin rotation is obtained when $\phi = 120^\circ$ and $\alpha = 35.2^\circ$.

The total field integral of such snake is 14.6 T·m.

Note that, the bending snake is not ramped with energy to keep its spin rotation constant. The constant field in the snake magnets creates excessive orbit bend at low energies, which requires correction. Although this overbend can be easily corrected, it may cause a large orbit perturbation near the bending snake. To avoid this problem one could consider turning the bending snake on adiabatically at about 100 GeV.

5.3 Conclusions

Strong depolarization effects in HERA would make polarized proton acceleration to 920 GeV a challenging problem. We propose to use four regular Siberian snakes which could easily be installed in existing free spaces in the four HERA straight sections. However, the successful acceleration of polarized protons with only 4 snakes would also require improvements to the beam quality. The 2-sigma vertical beam emittance should be reduced to about 5π mm·mrad, while the vertical closed orbit should be corrected to 0.2 mm rms errors; this could be a nontrivial task. A possible four-snake configuration is:

- a longitudinal snake at 0° (East),
- a -45° snake at 86.5° (North),
- a radial snake at 180° (West),
- a 45° snake at 273.5° (South),

where the azimuthal snake positions are given with respect to the center of the East straight section.

Moreover, the HERA proton ring is a non-flat accelerator, which causes additional difficulty for a polarized proton beam. Fortunately, the effect of the vertical bends near the collider detectors could be compensated by using special “flattening snakes”, which would make the optics of the long straight sections spin transparent. Each straight section with vertical bends would need a pair of these flattening snakes.

In addition to the four normal Siberian snakes and the four flattening snakes, we also suggest installing four spin rotators in HERA, one on each side of H1 and ZEUS. This would allow H1 and ZEUS to each choose their own polarization direction while keeping the polarization vertical in the rest of the ring.

References

- [1] SPIN Collaboration and DESY Polarization Team, “*Acceleration of polarized protons to 820 GeV at HERA*”, University of Michigan Report UM-HE 96-20, November 1996.
- [2] SPIN Collaboration, “*Acceleration of polarized protons to 120 GeV and 1 TeV at Fermilab*”, University of Michigan Report UM-HE 95-09, August 1995.
- [3] D.P. Barber, “*Prospects for polarized protons at HERA*”, International School of Nucleon Structure, Erice, Sicily, August 1995; D.P. Barber, “*Possibilities for polarized protons at HERA*”, in Prospects of spin physics at HERA, DESY-Zeuten, August 1995, DESY Report 95-200; G. Hoffstätter, “*Polarized protons in HERA*”, in Proc. of the DESY Accelerator Group Seminar, DESY Report 96-05, May 1996; V. Balandin, N. Golubeva and D.P. Barber, “*Studies of the behavior of proton spin motion in HERA-p at high energies*”, DESY Report M-96-04, May 1996.
- [4] J. Buon, “*Spin-transparent vertical beam kicker*”, in Proc. of the Workshop on Polarized Beams at SSC, Ann Arbor 1985, AIP Conf. Proc. **145**, 170 (1986).
- [5] S.Y. Lee and E.D. Courant, Phys. Rev. **D41**, 292 (1990).
- [6] E.D. Courant and R.D. Ruth, “*The acceleration of polarized protons in circular accelerators*”, BNL Report 51270 (1980).
- [7] K. Heinemann and G.H. Hoffstätter, Phys. Rev. E **54**, 4250 (1996).
- [8] M. Gentner *et al.*, Nucl. Instr. and Methods **A424**(2-3), 277 (1999).
R. Brinkmann *et al.*, DESY Report M-98-06L, Aug 1998.
- [9] “*The HERA Luminosity Upgrade*”, Editor: U. Schneekloth, Report DESY 98-05, July 1998.
- [10] V.V. Balandin, N.I. Golubeva and D.P. Barber, “*Studies of the Behavior of Proton Spin Motion in HERA-p at High Energies*”, Report DESY M 98-03, May 1998.
- [11] J. Maidman, Private Communications.
- [12] S.Y. Lee and S. Tepikian, Phys. Rev. Lett. **56**, 1635 (1986).
- [13] R.A. Phelps *et al.*, Phys. Rev. Lett. **78**, 2772 (1997).
- [14] V.A. Anferov, Phys. Rev. Special Topics - Accel. and Beams **1**, 071001 (1998);
G. Hoffstaetter, Section 4 of this Report.
- [15] Ya.S. Derbenev, “*Bending Siberian snakes*”, UM-HE 97-07 (1997).

6 Some tentative simple polarized beam ideas

On 17 November 1998, Prof. Wiik suggested that the SPIN@HERA Collaboration might try to provide a simple estimate of:

The maximum emittance and rms orbit distortion that would allow the safe acceleration of polarized protons to 920 GeV in HERA.

This simple estimate could help DESY to decide, around 2002, about the wisdom of trying to accelerate polarized protons after the emittance and rms orbit errors are reduced to some level during or after HERA's Luminosity Upgrade. This chapter is an attempt to respond to this suggestion by trying to develop a few simple ideas about:

- the best way to orient 4 Siberian snakes in HERA's proton ring
- the difficulty in overcoming different types of depolarizing resonances with more than 2 Siberian snakes.

We will try to indicate which of these ideas seem fairly firm and which require further verification. We must stress that most of these simple ideas are not rigorously proven; we invite others to confirm or refute them.

6.1 The spin tune with $2N_s$ Siberian snakes

Let the spin rotation axis of snake i be specified by the angle ϕ_i ($i=1,2,\dots, 2N_s$), where N_s is the number of snake pairs in HERA. Then the condition required for a spin tune of $1/2$ is:

$$\sum_i (-1)^i \phi_i = (2n + 1) \cdot 90 \text{ deg} . \quad (6.1)$$

This Condition seems rather well established.

6.2 "Orthogonal" spin rotation axes

Condition (6.1) still allows considerable freedom in the choice of ϕ_i 's. While it is not proven, it appears that the best choice is:

$$\text{Make each snake as orthogonal as possible to both neighboring snakes.} \quad (6.2)$$

With 4 snakes (2 pairs), Conditions (6.1) and (6.2) seem to suggest that adjacent snakes should be at 45 degree angles to each other. This is consistent with the proposal of Vogt et al. (0 deg, 45 deg, 90 deg, -45 deg), which also satisfies Condition (6.1).

6.3 Different depolarizing factors

A simple computer program was written by Courant to study the HERA proton ring with 4 Siberian snakes using the following assumptions:

- The HERA lattice is simplified as a string of FODO cells.

- Protons have vertical betatron oscillations with a specified emittance.
- The vertical closed orbit is simulated by misaligning the quadrupoles.
- No orbit correction is applied.

Protons were then traced during acceleration from 653 GeV to 834 GeV and their vertical polarization was calculated for many values of three parameters:

- the emittance,
- the rms orbit,
- the vertical tune.

The results, which are summarized below, should give some estimate of the general trend of the beam polarization's dependence on these three parameters.

- With emittance = 10π mm·mr and zero orbit errors, when the polarization was calculated for many different values of ν_y , one saw an array of snake resonances at ν_y values such as $1/6$, $1/10$, $1/14$, [numerator = odd integer; denominator = 2·odd integer], as predicted by Lee and Tepikian [1].
- The widths of intrinsic resonances seem to grow as $\sqrt{\text{emittance}}$.
- When the polarization was calculated, with zero emittance and rms orbit of 0.2 mm, for the same values of ν_y , one saw fewer and weaker resonances. For emittances up to 10π mm·mr, the polarization was maintained if the rms orbit was not more than about 0.2 mm, but rapidly deteriorated for rms orbits above about 0.3 mm.

6.4 General observations about polarized protons in HERA

These results and other observations suggest the following general ideas:

- ν_y is a very sensitive parameter; a wrong choice of ν_y may be very bad. Snake Resonances may occur at the ν_y values described in 6.3a and their strengths may increase strongly with emittance and rms orbit.
- When the rms orbit is zero, a large emittance (up to 10π) can possibly be tolerated with only 4 snakes in HERA.
- Even with zero emittance, the orbit errors can still play an important role through the imperfection resonances. Any rms orbit above 0.2 mm can substantially reduce the polarization.
- The polarization's relative insensitivity to emittance and the relative sensitivity to orbit errors may occur because: $2N_s$ snakes seem to reduce the "effective" intrinsic resonance strengths for ALL intrinsic resonances, according to:

$$\varepsilon_{eff} = \varepsilon_{int}/N_s; \quad (6.3)$$

however, $2N_s$ snakes seem to reduce the "effective" imperfection resonance strength according to:

$$\varepsilon_{eff} = \varepsilon_{imp}/N_s, \quad (6.4)$$

ONLY for those imperfection resonances near the strong intrinsic resonances. Fortunately, these "near" imperfection resonances seem to be the strongest imperfection resonances.

e) With 4 Siberian snakes in HERA's proton ring, the largest safe beam parameters may be:

$$\text{emittance} = 10\pi \text{ mm} \cdot \text{mr} ; \quad (6.5)$$

$$\text{rms orbit error} = 0.2 \text{ mm} . \quad (6.6)$$

f) One should choose ν_y to avoid the snake resonances discussed in comment 6.3a.

References

- [1] S.Y. Lee and S. Tepikian, Phys. Rev. Lett. **78**, 2772 (1986).