

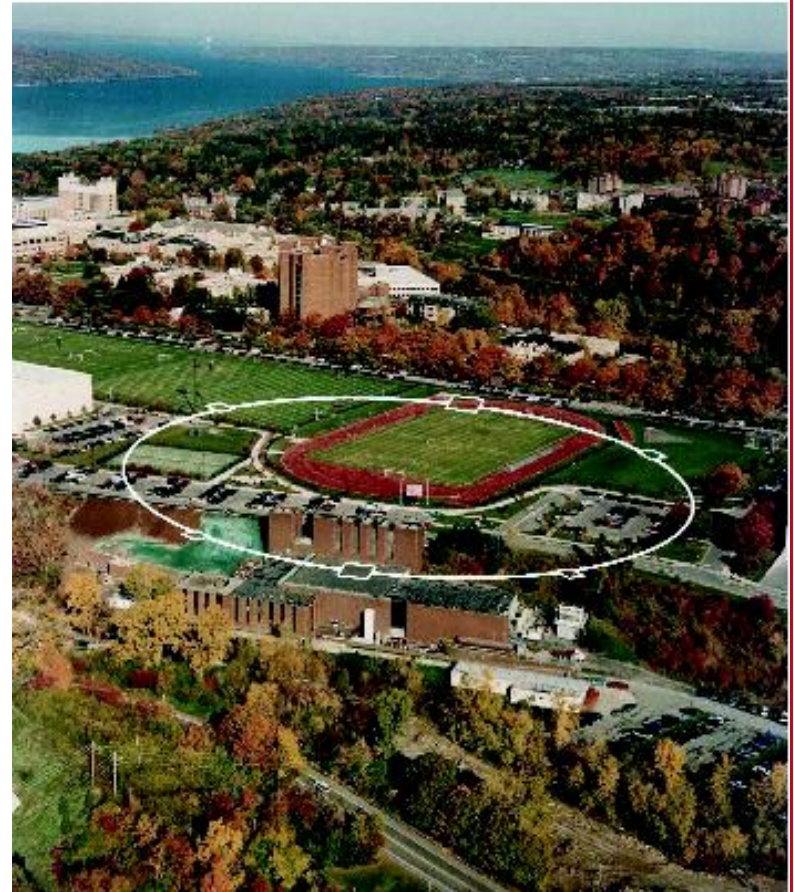

## Content

1. A History of Particle Accelerators
2. E & M in Particle Accelerators
3. Linear Beam Optics in Straight Systems
4. Linear Beam Optics in Circular Systems
5. Nonlinear Beam Optics in Straight Systems
6. Nonlinear Beam Optics in Circular Systems
7. Injection and Extraction
8. Accelerator Measurements
9. RF Systems for Particle Acceleration
10. Luminosity





## Required:

Particle Accelerator Physics I, Helmut Wiedemann, Springer, 2nd edition, 1999, ISBN 3 540 64671 x

## Optional:

The Physics of Particle Accelerators, Klaus Wille, Oxford University Press, 2000, ISBN: 19 850549 3

## Related material:

Handbook of Accelerator Physics and Engineering, Alexander Wu Chao and Maury Tigner, 2nd edition, 2002, World Scientific, ISBN: 981 02 3858 4

Particle Accelerator Physics II, Helmut Wiedemann, Springer, 2nd edition, 1999, ISBN 3 540 64504 7



# What is accelerator physics



CHESS & LEPP

Accelerator Physics has applications in particle accelerators for high energy physics or for x-ray science, in spectrometers, in electron microscopes, and in lithographic devices. These instruments have become so complex that an empirical approach to properties of the particle beams is by no means sufficient and a detailed theoretical understanding is necessary. This course will introduce into theoretical aspects of charged particle beams and into the technology used for their acceleration.

- Physics of beams
- Physics of non-neutral plasmas
- Physics of involved in the technology:
  - Superconductivity in magnets and radiofrequency (RF) devices
  - Surface physics in particle sources, vacuum technology, RF devices
  - Material science in collimators, beam dumps, superconducting materials



# Different accelerators



CHESS & LEPP

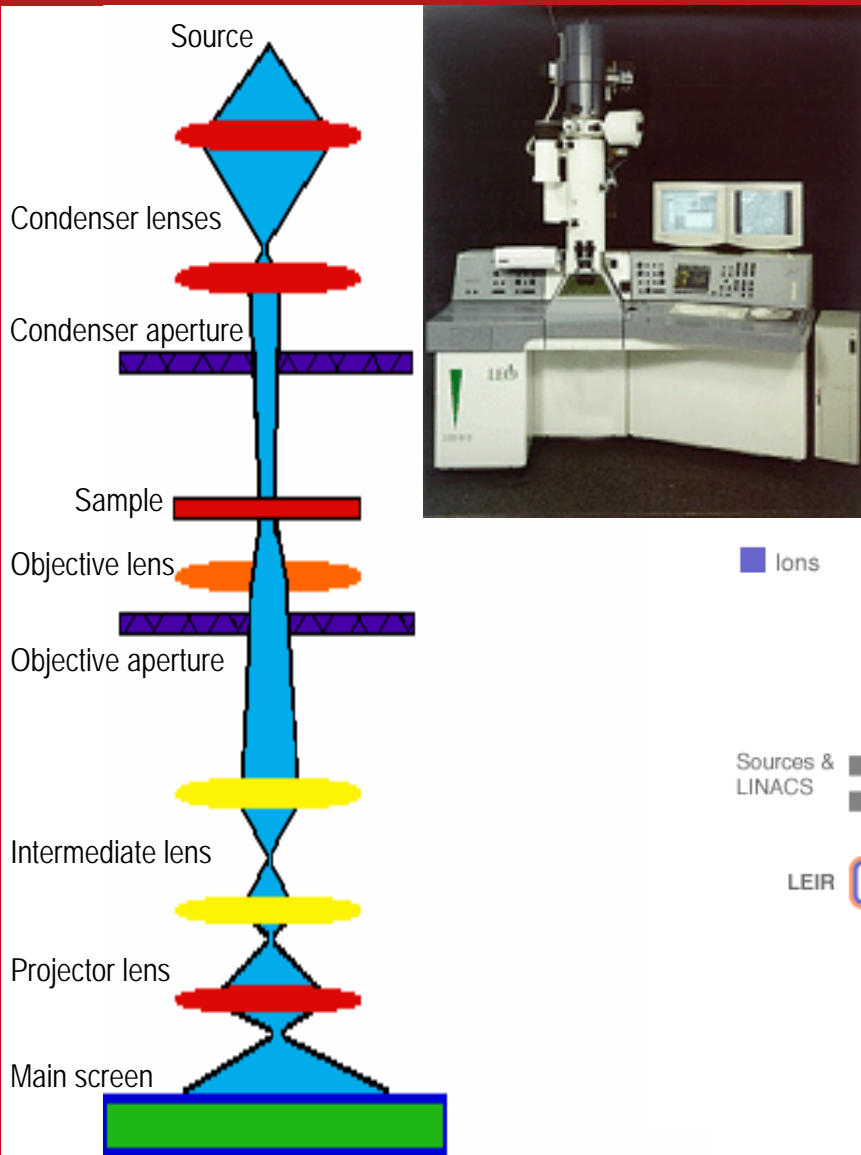

■ Ions     
 ■ Protons     
 ■ Antiprotons

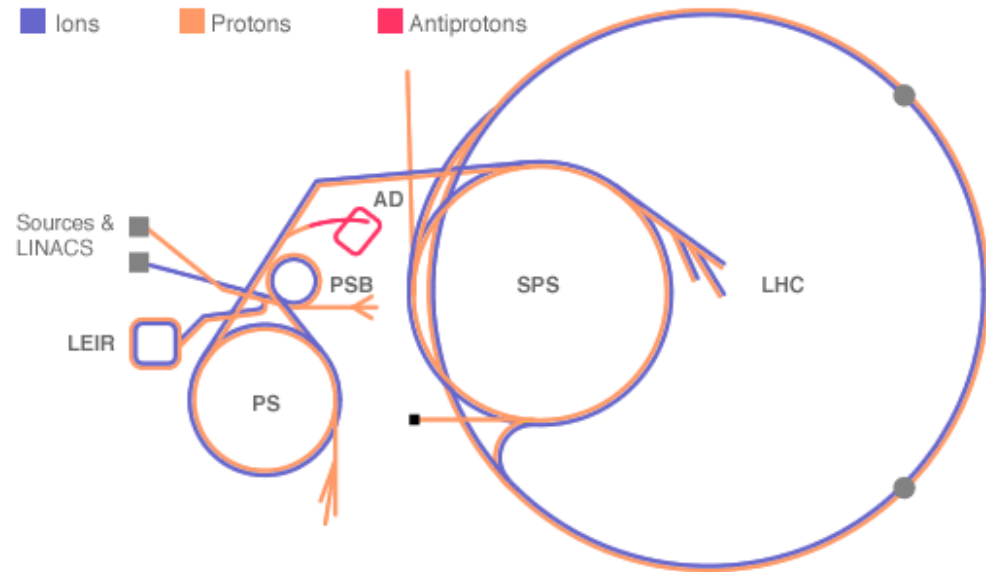



# A short history of accelerators



CHESS & LEPP

- 1862: Maxwell theory of electromagnetism
- 1887: Hertz discovery of the electromagnetic wave
- 1886: Goldstein discovers positively charged rays (ion beams)
- 1894: Lenard extracts cathode rays (with a 2.65um Al Lenard window)
- 1897: JJ Thomson shows that cathode rays are particles since they followed the classical Lorentz force  $m\vec{a} = e(\vec{E} + \vec{v} \times \vec{B})$  in an electromagnetic field
- 1926: GP Thomson shows that the electron is a wave  
(1929-1930 in Cornell, NP in 1937)



NP 1905

Philipp E.A. von Lenard  
Germany 1862-1947

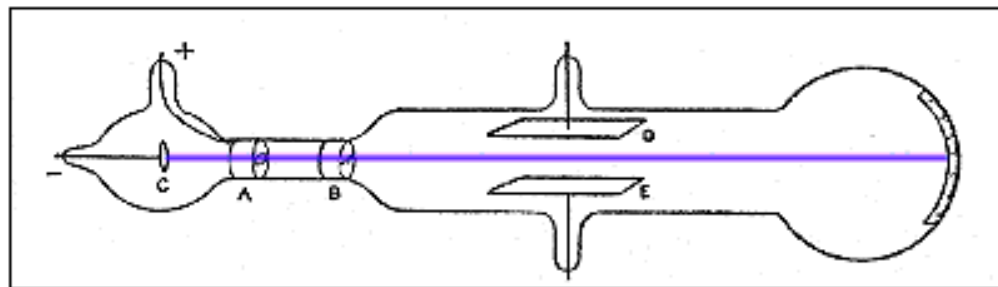

NP 1906

Joseph J. Thomson  
UK 1856-1940



## A short history of accelerators



CHESS & LEPP

- 1911: Rutherford discovers the nucleus with 7.7MeV  $^4\text{He}$  from  $^{214}\text{Po}$  alpha decay measuring the elastic crosssection of  $^{197}\text{Au} + ^4\text{He} \mapsto ^{197}\text{Au} + ^4\text{He}$ .

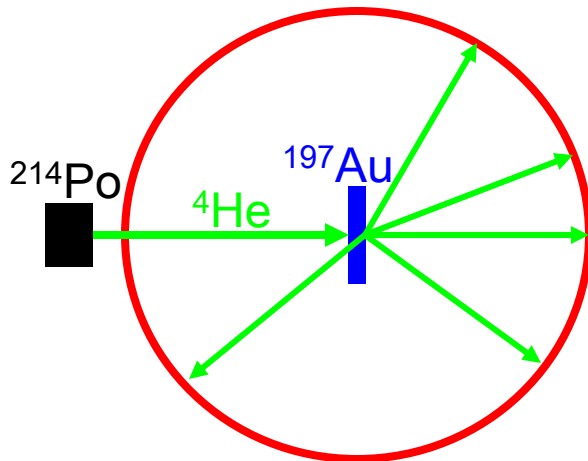

$$E = \frac{Z_1 e Z_2 e}{4\pi\epsilon_0 d} = Z_1 Z_2 m_e c^2 \frac{r_e}{d},$$

$$r_e = 2.8\text{fm}, \quad m_e c^2 = 0.511\text{MeV}$$

$d$  = smallest approach for back scattering

- 1919: Rutherford produces first nuclear reactions with natural  $^4\text{He}$   
 $^{14}\text{N} + ^4\text{He} \mapsto ^{17}\text{O} + \text{p}$
- 1921: Greinacher invents the cascade generator for several 100 keV
- Rutherford is convinced that several 10 MeV are in general needed for nuclear reactions. He therefore gave up the thought of accelerating particles.



# Tunneling allows low energies



CHESS & LEPP

- 1928: Explanation of alpha decay by Gamov as tunneling showed that several 100keV protons might suffice for nuclear reactions

Schroedinger equation: 
$$\frac{\partial^2}{\partial r^2} u(r) = \frac{2m}{\hbar^2} [V(r) - E] u(r), \quad T = \left| \frac{u(L)}{u(0)} \right|^2$$

The transmission probability  $T$  for an alpha particle traveling from the inside towards the potential well that keeps the nucleus together determines the lifetime for alpha decay.

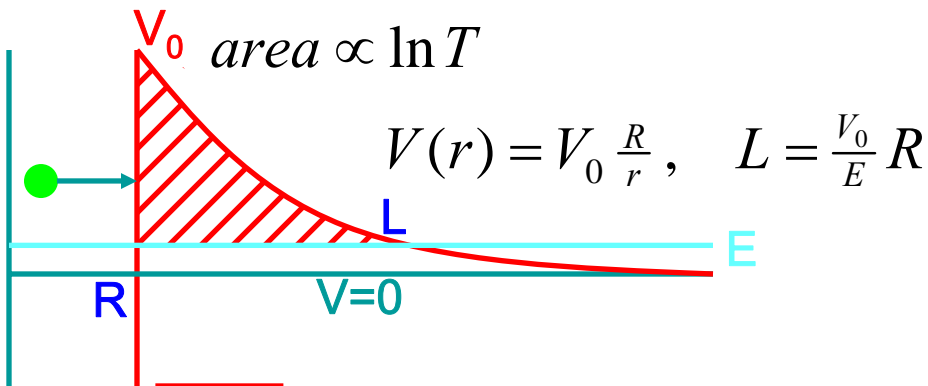

$$T \approx \exp\left[-2 \int_R^L \frac{\sqrt{2m[V(r)-E]}}{\hbar} dr\right]$$

$$\ln T \approx A - \frac{C}{\sqrt{E}}$$

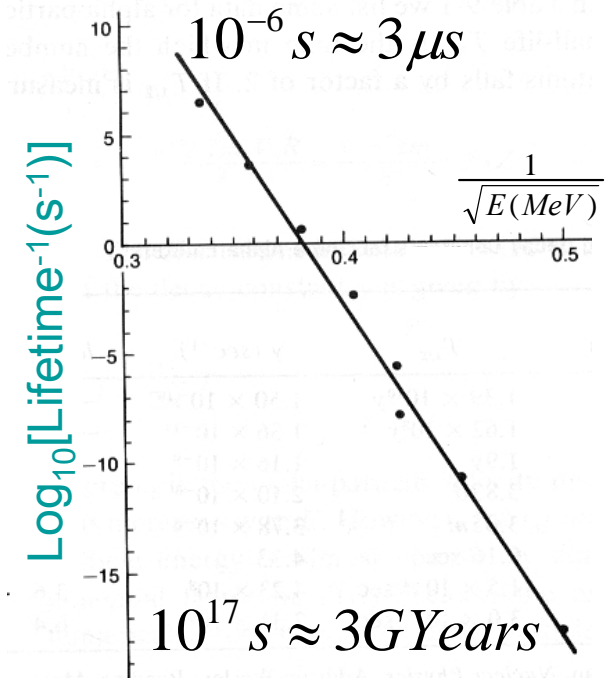



# Three historic lines of accelerators



CHESS & LEPP

## Direct Voltage Accelerators

### Resonant Accelerators

### Transformer Accelerator

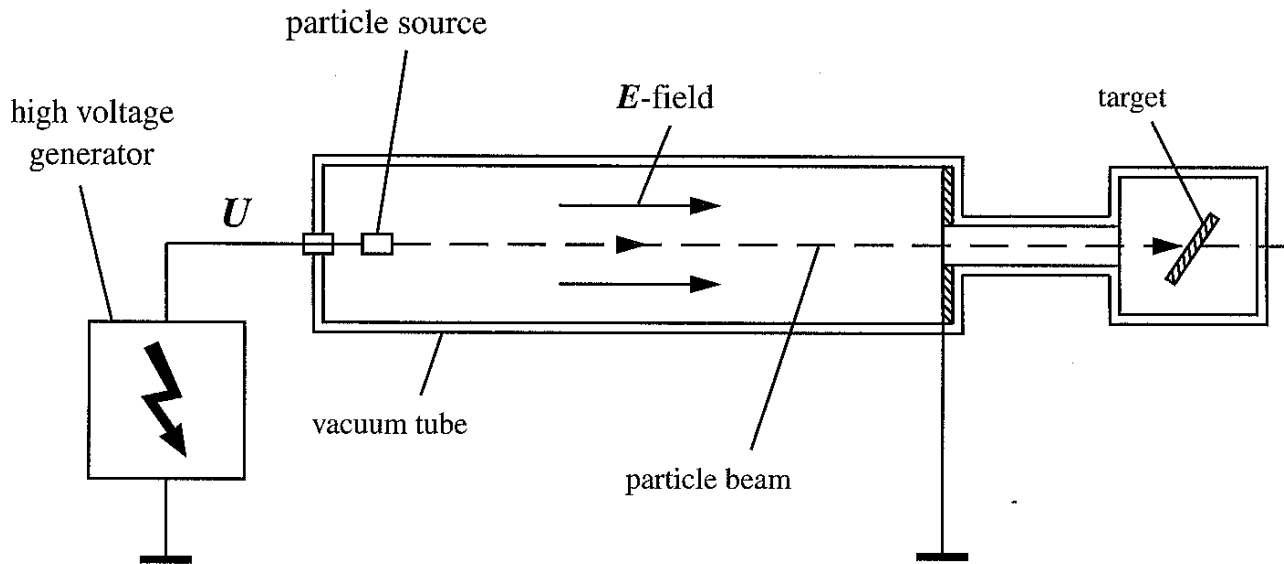

Voltage 1MV  
Charge  $Ze$   
Energy  $Z$  MeV

The energy limit is given by the maximum possible voltage. At the limiting voltage, electrons and ions are accelerated to such large energies that they hit the surface and produce new ions. An avalanche of charge carries causes a large current and therefore a breakdown of the voltage.





# The Van de Graaff Accelerator



CHESS & LEPP

- 1930: van de Graaff builds the first 1.5MV high voltage generator

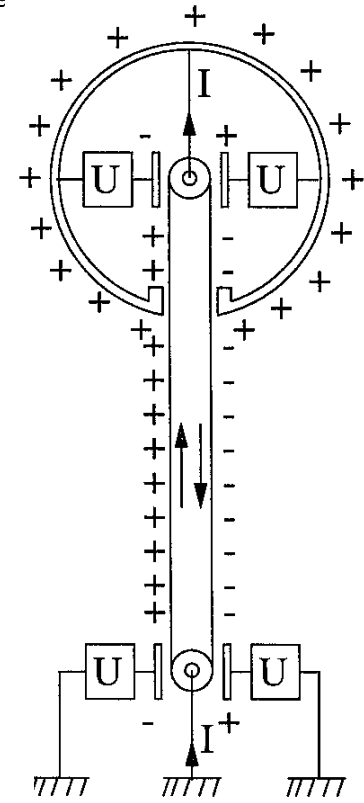
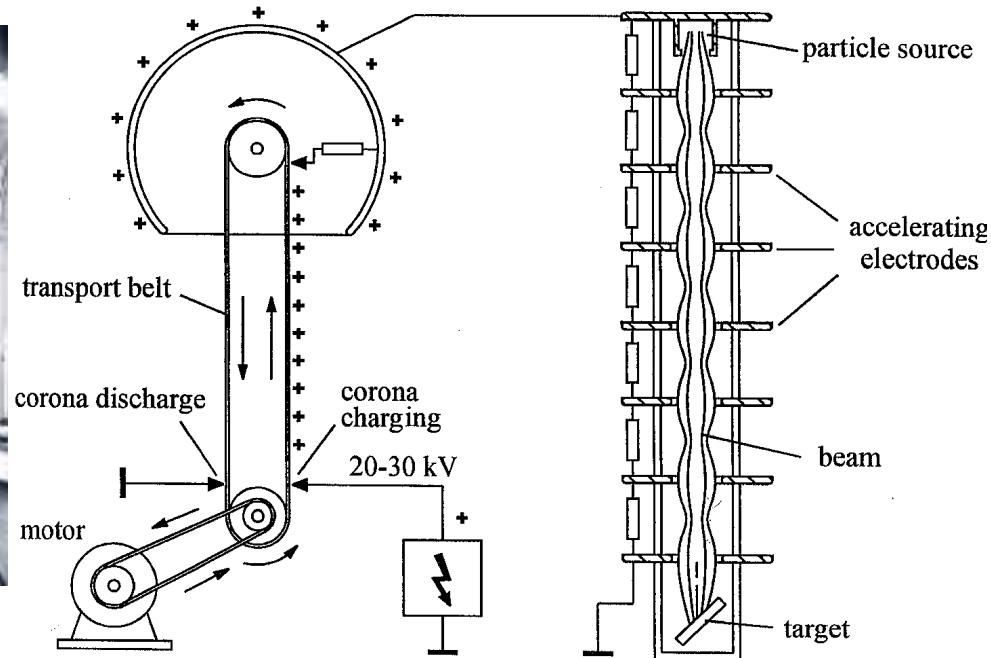

Van de Graaff

- Today Pelletrons (with chains) or Laddertron (with stripes) that are charged by influence are commercially available.
- Used as injectors, for electron cooling, for medical and technical n-source via  $d + t \rightarrow n + \alpha$
- Up to 17.5 MV with insulating gas (1MPa SF<sub>6</sub>)



# The Tandem Accelerator



CHESS & LEPP

- Two Van de Graaffs, one + one -
- The Tandem Van de Graaff, highest energy 35MeV

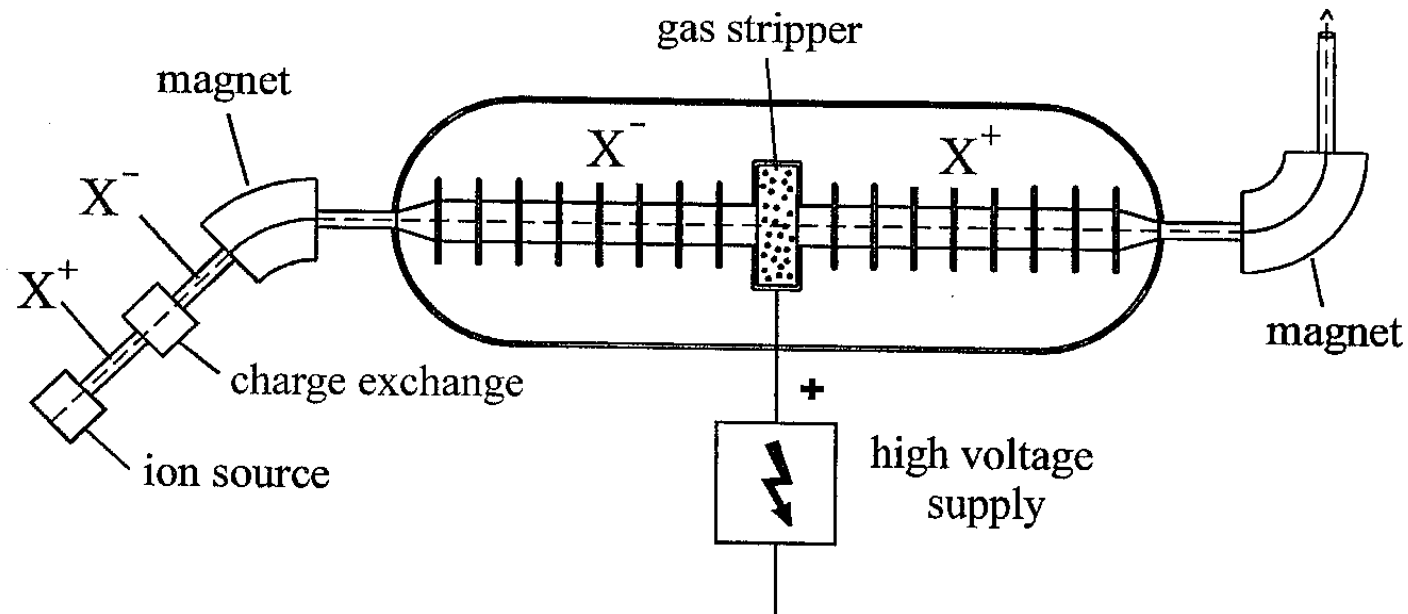

- 1932: Brasch and Lange use potential from lightning, in the Swiss Alps, Lange is fatally electrocuted

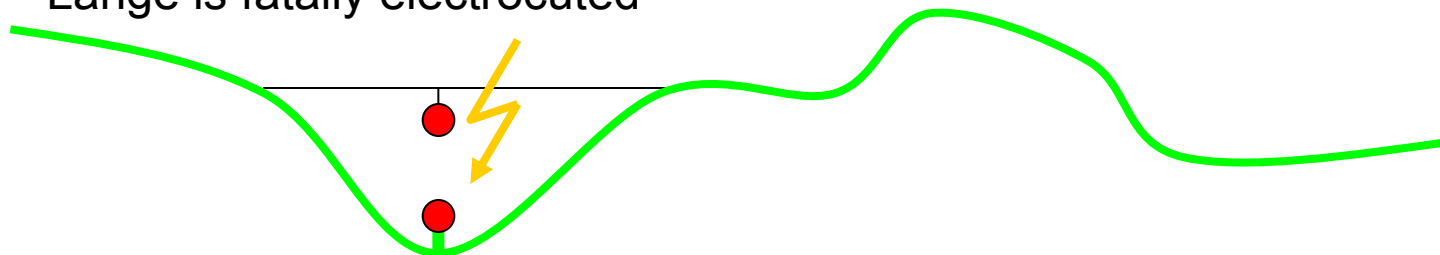



# The Cockcroft-Walton Accelerator



CHESS & LEPP

1932: Cockcroft and Walton 1932: 700keV cascade generator (planned for 800keV) and use initially 400keV protons for  ${}^7\text{Li} + p \mapsto {}^4\text{He} + {}^4\text{He}$  and  ${}^7\text{Li} + p \mapsto {}^7\text{Be} + n$

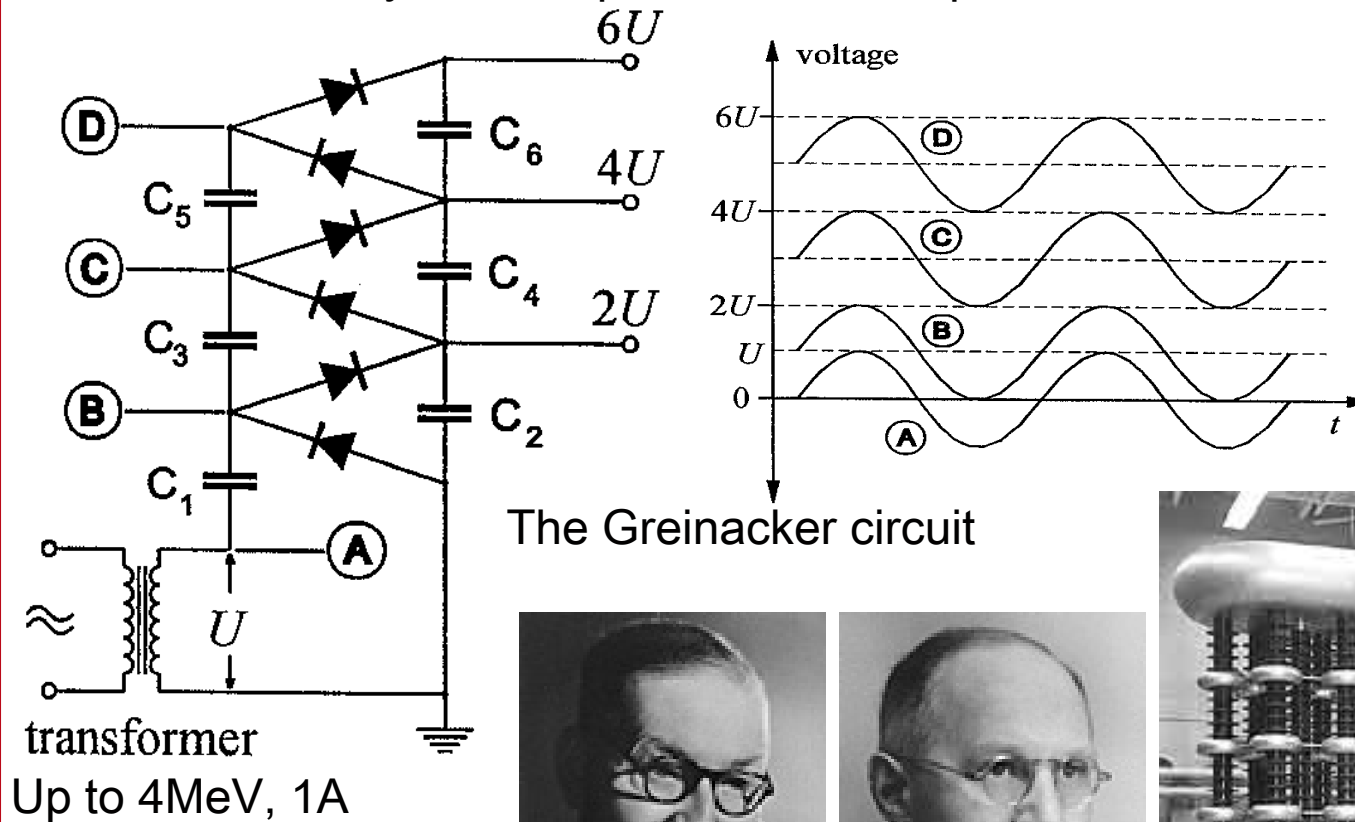

The Greinacker circuit

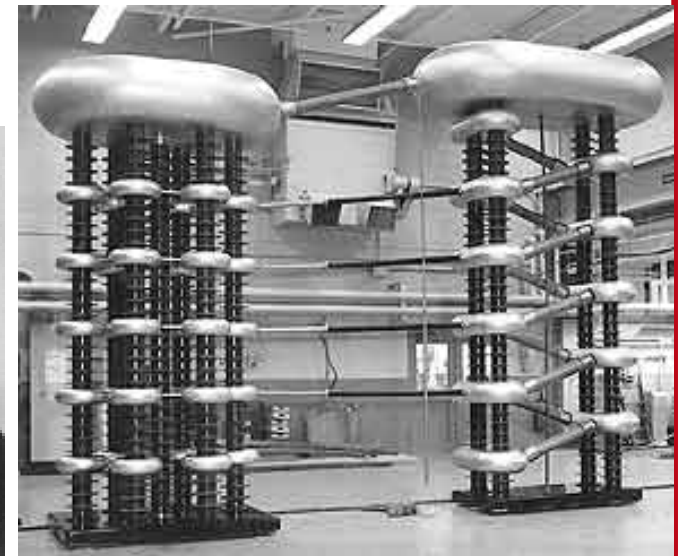

NP 1951  
Sir John D Cockcroft  
Ernest T S Walton



# The Marx Generator



CHESS & LEPP

- 1932: Marx Generator achieves 6MV at General Electric

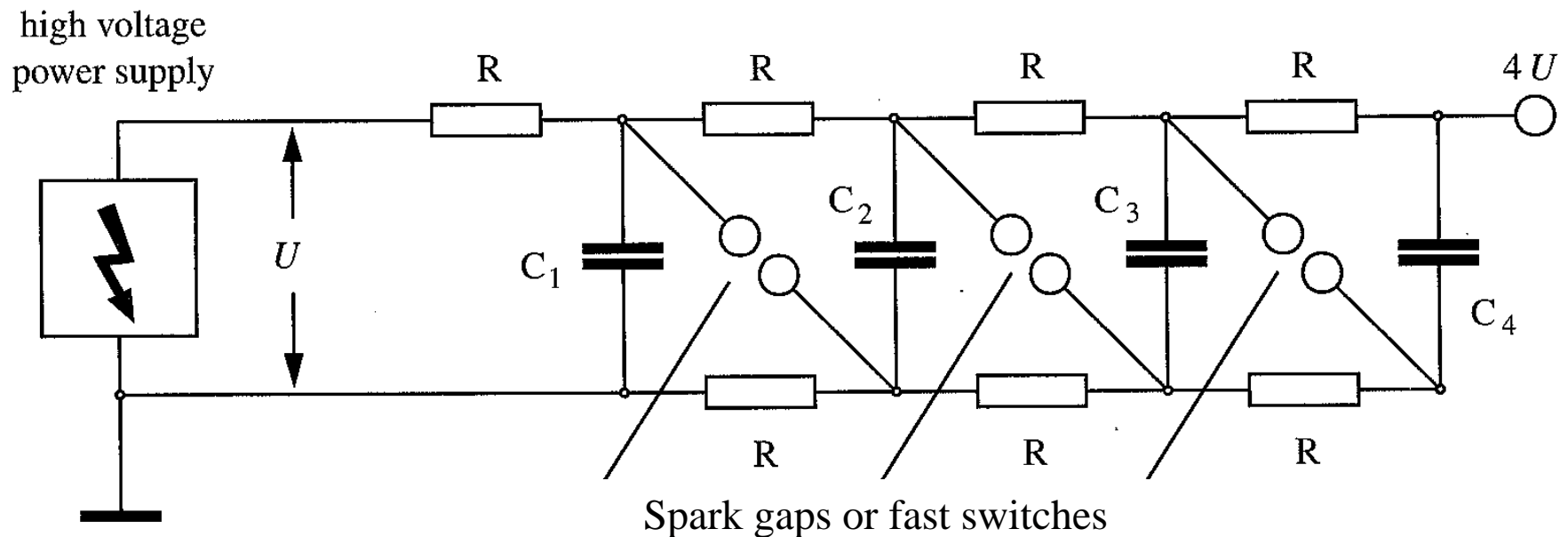

After capacitors of around 2 $\mu$ F are filled to about 20kV, the spark gaps or switches close as fast as 40ns, allowing up to 500kA.

Today:

The Z-machine (Physics Today July 2003) for z-pinch initial confinement fusion has 40TW for 100ns from 36 Marx generators



# Three historic lines of accelerators



CHESS & LEPP

## Direct Voltage Accelerators



## Resonant Accelerators

## Transformer Accelerator

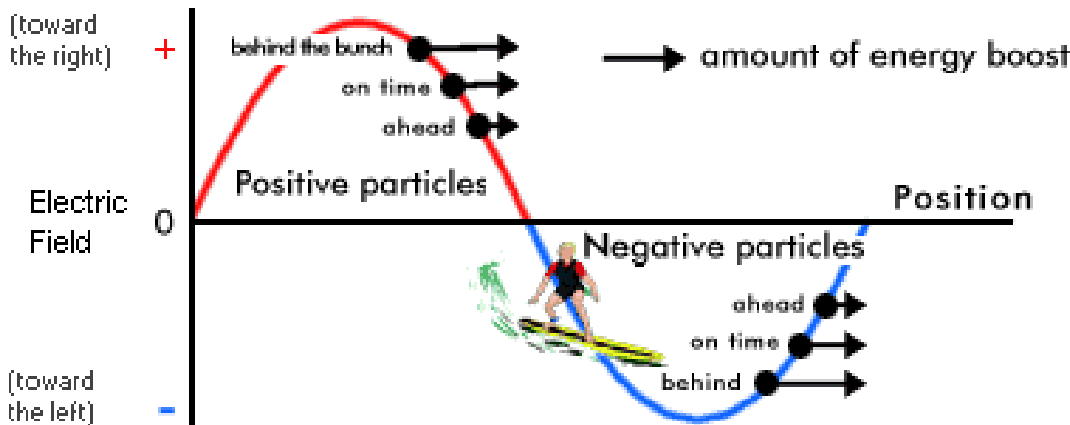
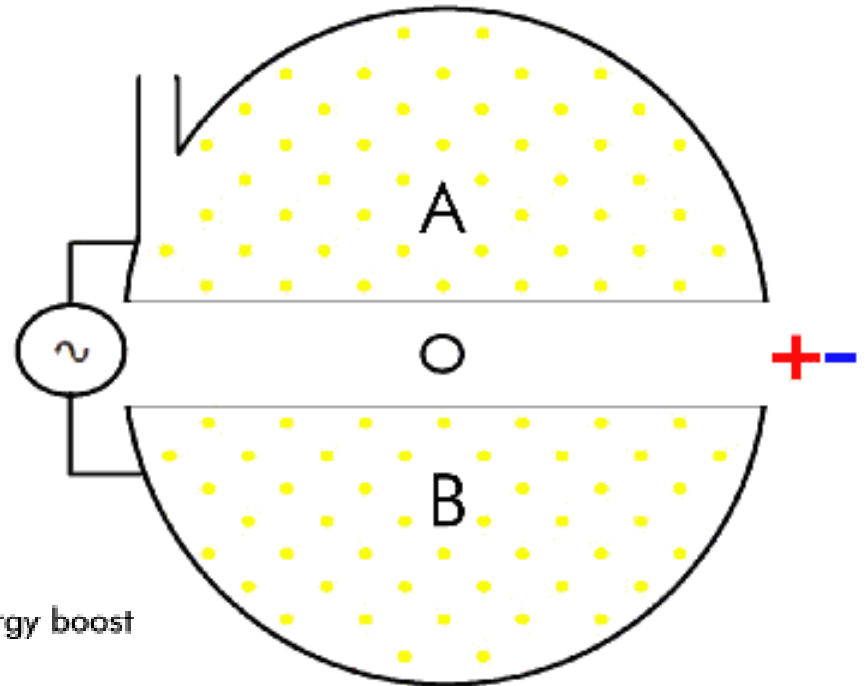

Particles must have the correct phase relation to the accelerating voltage.



# The Cyclotron



CHESS & LEPP

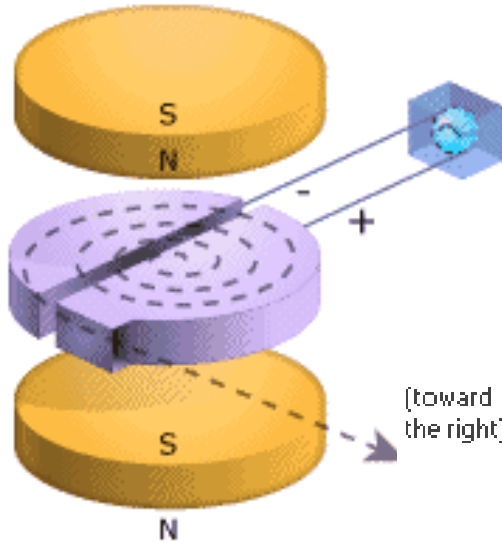

(toward the right)

Electric Field

(toward the left)

- 1930: Lawrence proposes the Cyclotron (before he develops a workable color TV screen)
- 1932: Lawrence and Livingston use a cyclotron for 1.25MeV protons and mention longitudinal (phase) focusing

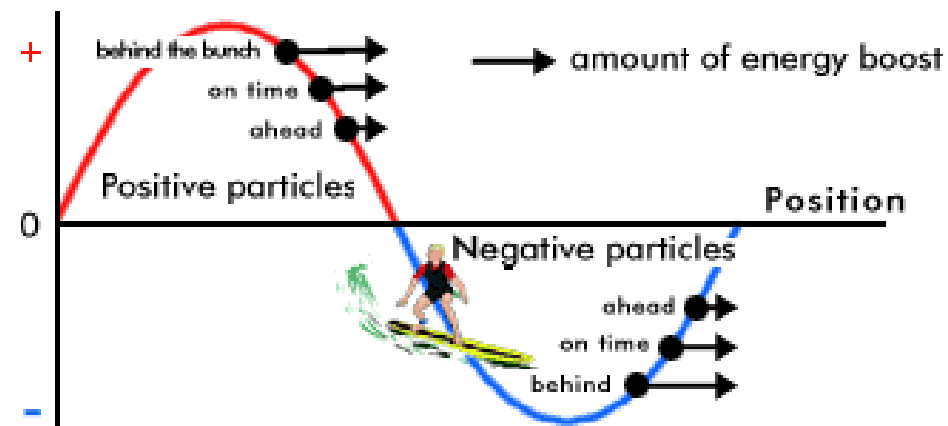

NP 1939

Ernest O Lawrence

USA 1901-1958

- 1934: Livingston builds the first Cyclotron away from Berkely (2MeV protons) at Cornell (in room B54)



M Stanley Livingston

USA 1905-1986



# The cyclotron frequency



CHESS &amp; LEPP

$$F_r = m_0 \gamma \omega_z v = qvB_z$$

$$\omega_z = \frac{q}{m_0 \gamma} B_z = \text{const}$$

Condition: Non-relativistic particles.

Therefore not for electrons.

- The synchrocyclotron:

Acceleration of bunches with decreasing

$$\omega_z(E) = \frac{q}{m_0 \gamma(E)} B_z$$

- The isocyclotron with constant

$$\omega_z = \frac{q}{m_0 \gamma(E)} B_z(r(E))$$

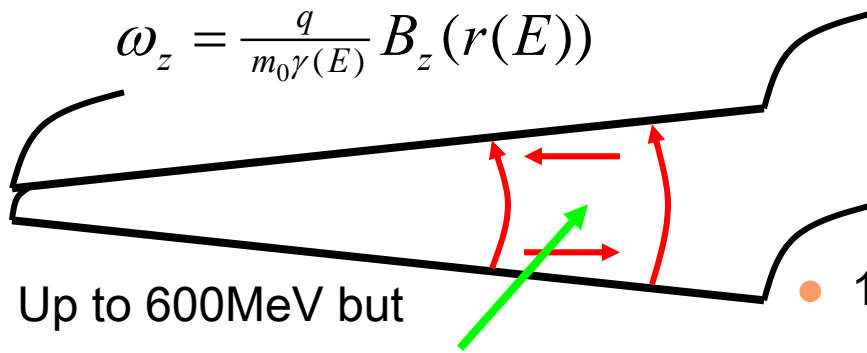

Up to 600MeV but  
this vertically defocuses the beam

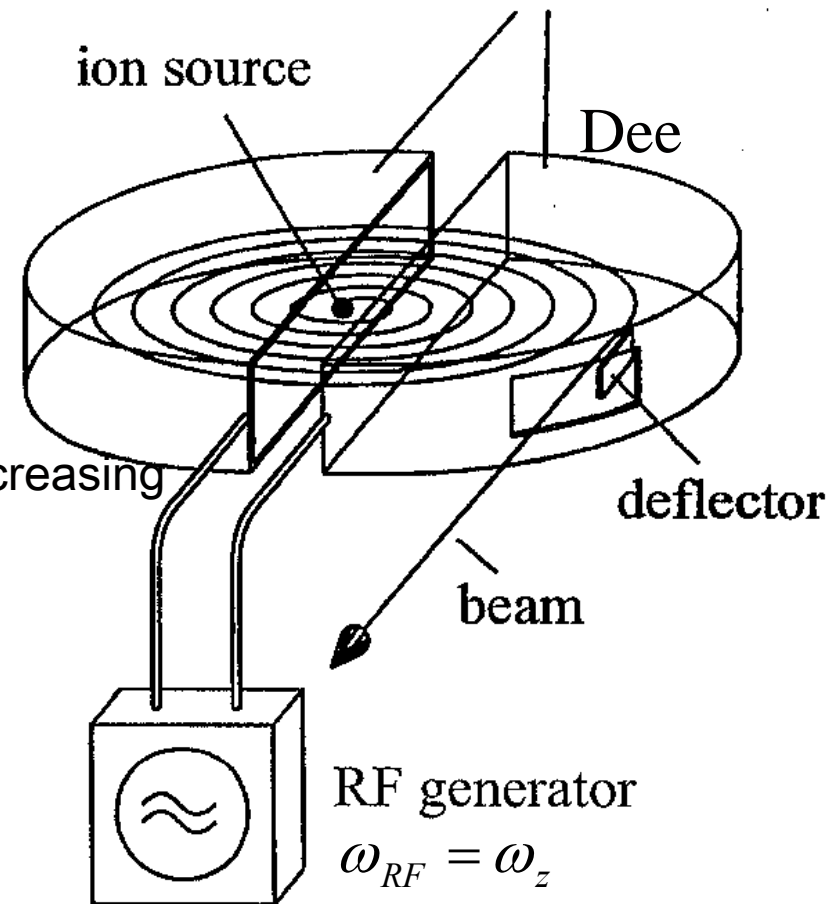

- 1938: Thomas proposes strong (transverse) focusing for a cyclotron



## First Medical Applications



CHESS & LEPP

- 1939: Lawrence uses 60' cyclotron for 9MeV protons, 19MeV deuterons, and 35MeV  $^4\text{He}$ . First tests of tumor therapy with neutrons via  $d + t \rightarrow n + \alpha$   
With 200-800keV d to get 10MeV neutrons.







## The Loma Linda proton therapy facility

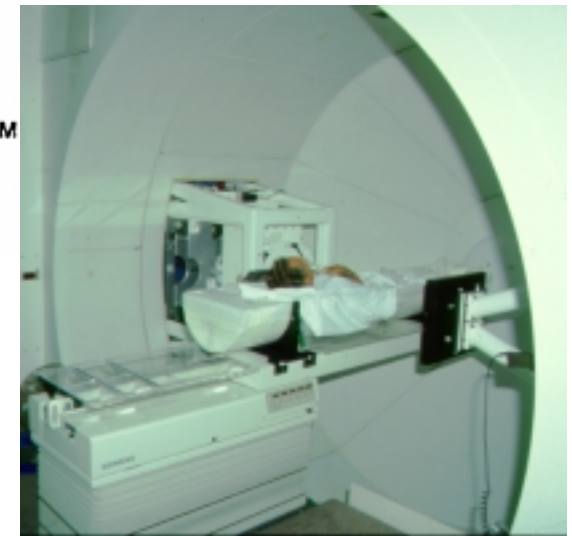
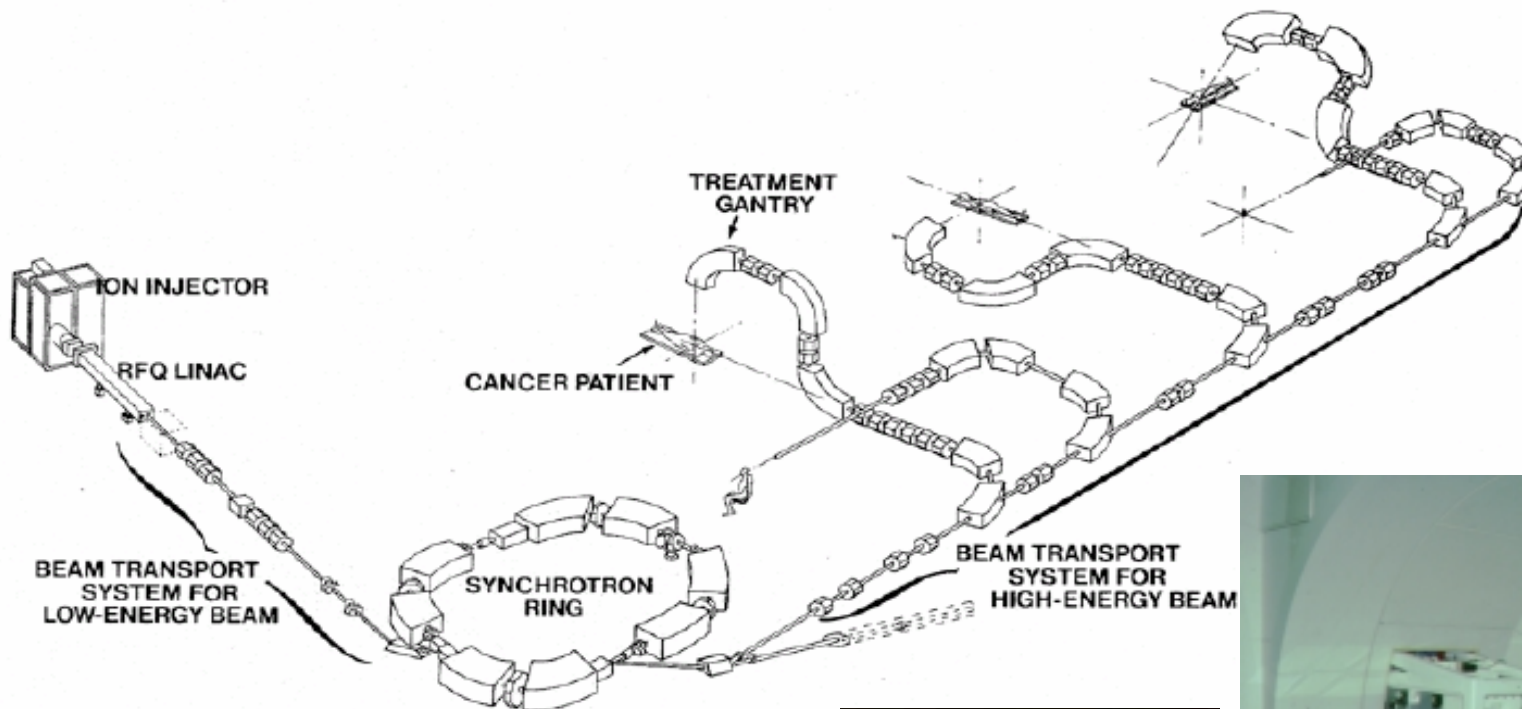



# The microtron



CHESS & LEPP

- Electrons are quickly relativistic and cannot be accelerated in a cyclotron.
- In a microtron the revolution frequency changes, but each electron misses an integer number of RF waves.

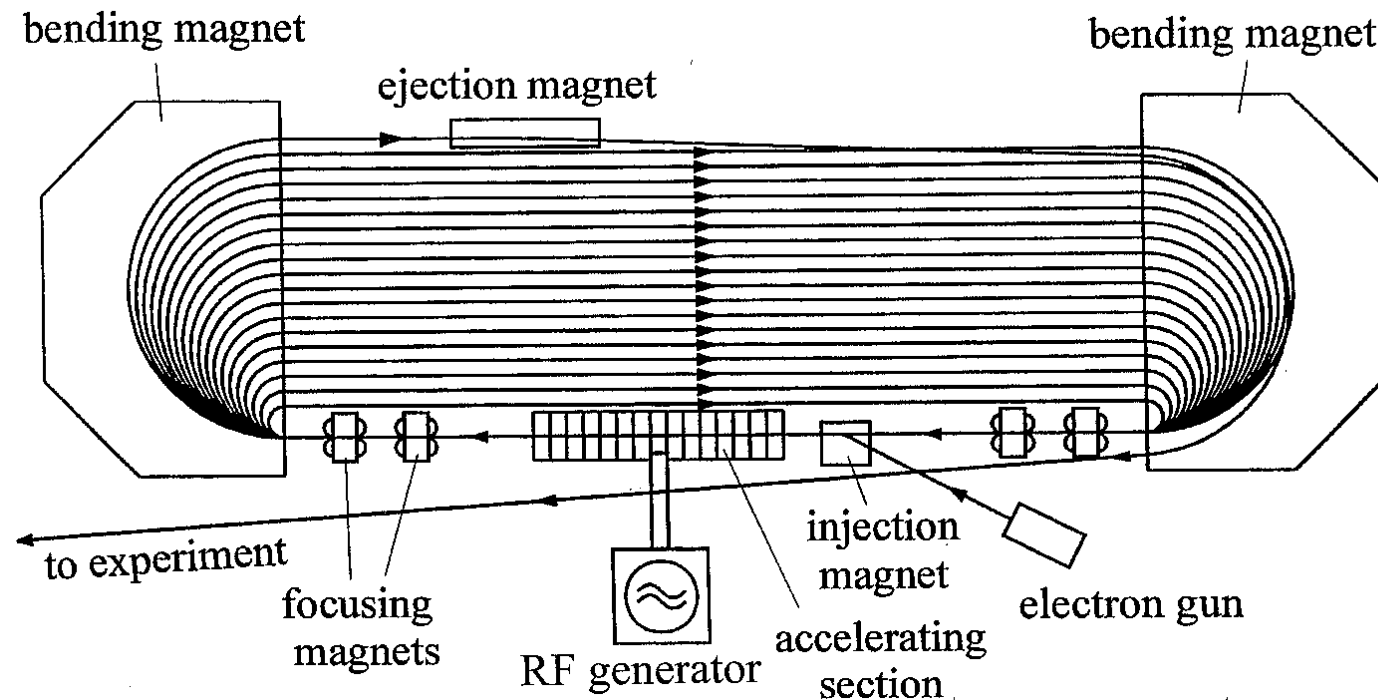

- Today: Used for medical applications with one magnet and 20MeV.
- Nuclear physics: MAMI designed for 820MeV as race track microtron.



# The microtron condition



CHESS &amp; LEPP

- The extra time that each turn takes must be a multiple of the RF period.

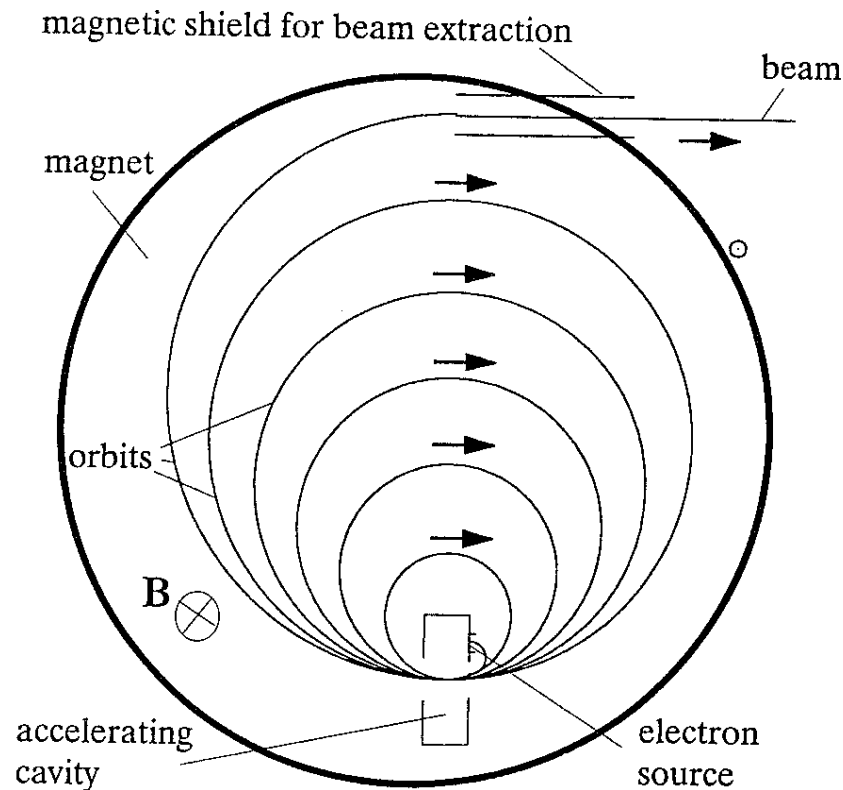

$$\frac{dp}{dt} = qvB \Rightarrow \rho = \frac{dl}{d\phi} = \frac{vdt}{dp/p} = \frac{p}{qB}$$

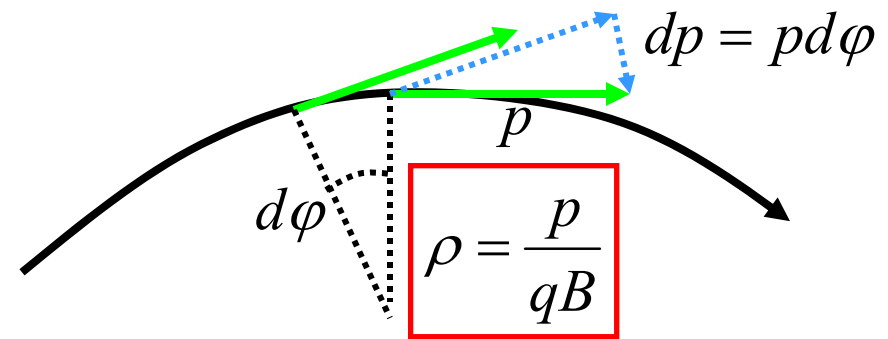

$$\Delta t = 2\pi \left( \frac{\rho_{n+1}}{v_{n+1}} - \frac{\rho_n}{v_n} \right)$$

$$= \frac{2\pi}{qB} (m_0 \gamma_{n+1} - m_0 \gamma_n) = \frac{2\pi}{qBc^2} \Delta K$$

$$\Delta K = n \frac{qBc^2}{\omega_{RF}} \quad \text{for an integer } n$$

$B=1\text{T}$ ,  $n=1$ , and  $f_{RF}=3\text{GHz}$  leads to  $4.78\text{MeV}$

This requires a small linear accelerator.



# Wideroe linear accelerator



CHESS & LEPP

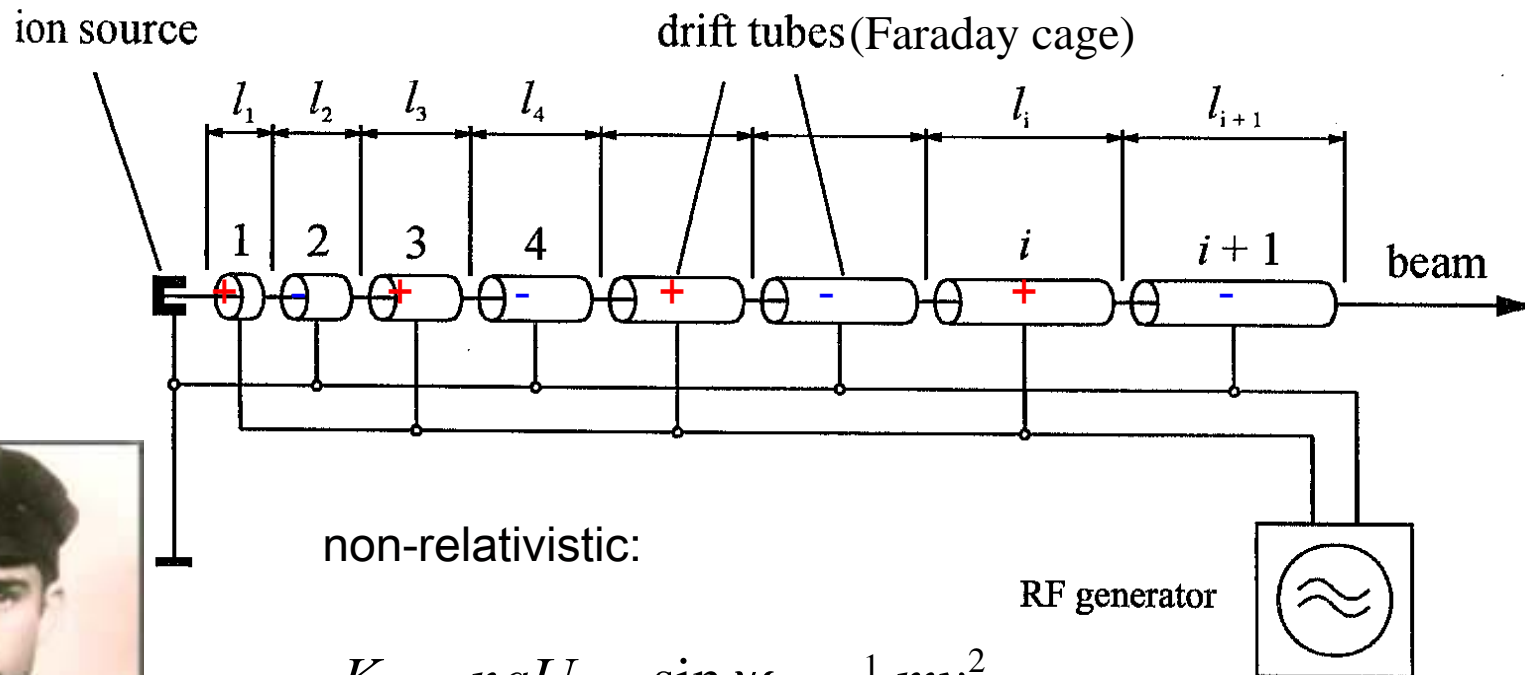

non-relativistic:

$$K_n = nqU_{\max} \sin \psi_0 = \frac{1}{2} m v_n^2$$

$$l_n = \frac{1}{2} v_n T_{RF} = \frac{1}{2} \beta_n \lambda_{RF} \propto \sqrt{n}$$

Called the  $\pi$  or the  $1/2\beta\lambda$  mode



Wideroe



# Accelerating cavities



CHESS & LEPP

- 1933: J.W. Beams uses resonant cavities for acceleration

## Traveling wave cavity:

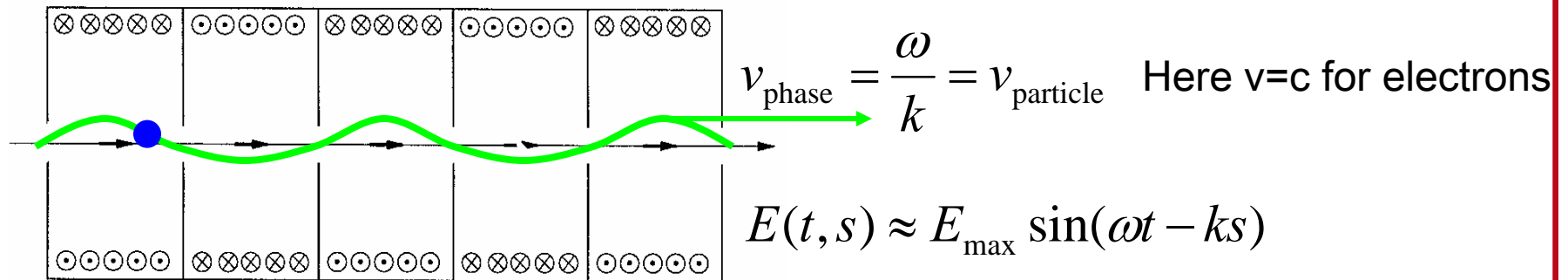

## Standing wave cavity:

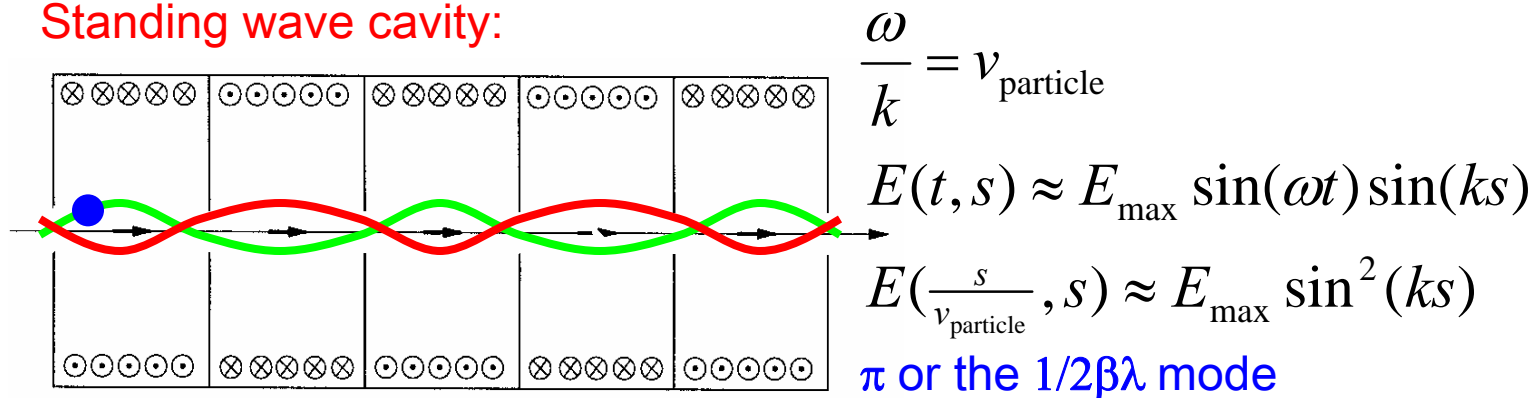

Transit factor (for this example):  $\langle E \rangle = \frac{1}{\lambda_{RF}} \int_0^{\lambda_{RF}} E\left(\frac{s}{v_{\text{particle}}}, s\right) ds \approx \frac{1}{2} E_{\text{max}}$



# The Alvarez Linear Accelerator



CHESS & LEPP

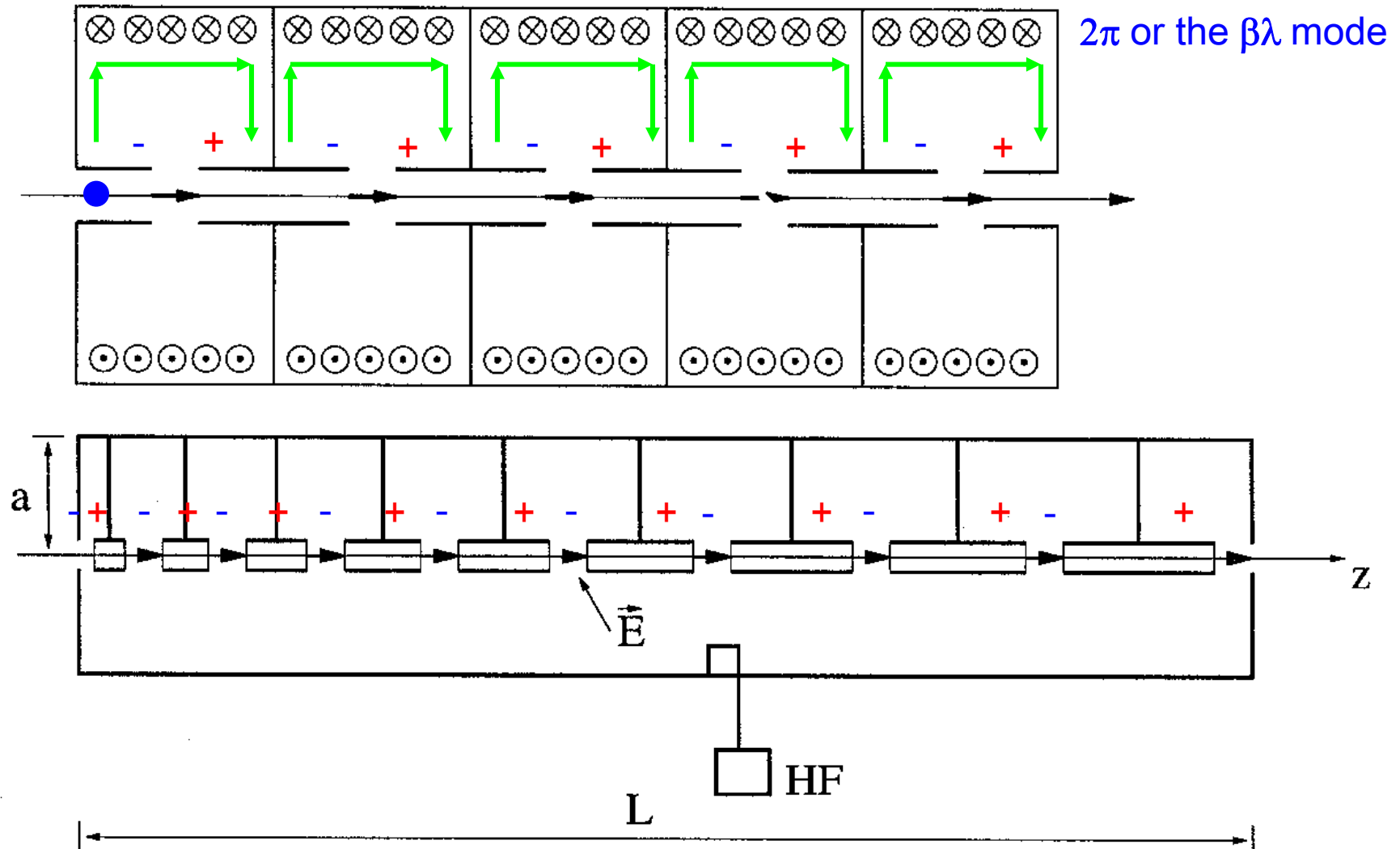

Needs only one power input coupler and walls do not dissipate energy.



# Phase focusing



CHESS & LEPP

- 1945: Veksler (UDSSR) and McMillan (USA) realize the importance of phase focusing

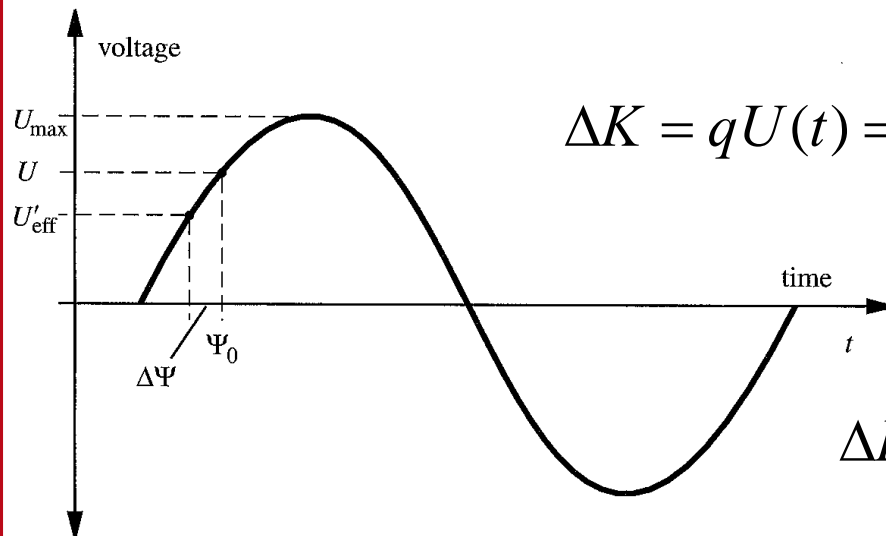

$$\Delta K = qU(t) = qU_{\max} \sin(\omega(t - t_0) + \psi_0)$$

Longitudinal position in the bunch:

$$\sigma = s - s_0 = -v_0(t - t_0)$$

$$\Delta K(\sigma) = qU_{\max} \sin\left(-\frac{\omega}{v_0}(s - s_0) + \psi_0\right)$$

$$\Delta K(0) > 0 \quad (\text{Acceleration})$$

$$\Delta K(\sigma) < \Delta K(0) \text{ for } \sigma > 0 \Rightarrow \frac{d}{d\sigma} \Delta K(\sigma) < 0 \quad (\text{Phase focusing})$$

$$\left. \begin{array}{l} qU(t) > 0 \\ q \frac{d}{dt} U(t) > 0 \end{array} \right\} \underline{\underline{\psi_0 \in (0, \frac{\pi}{2})}}$$

Phase focusing is required in any RF accelerator.



# The RF quadrupole (RFQ)



CHESS & LEPP



- 1970: Kapchinskii and Teplyakov invent the RFQ

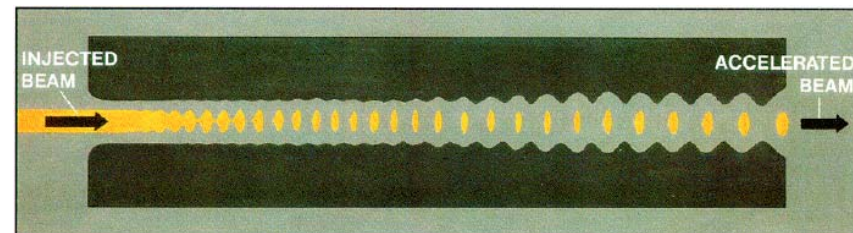
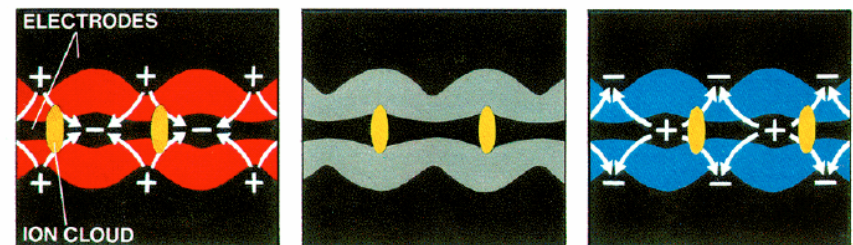
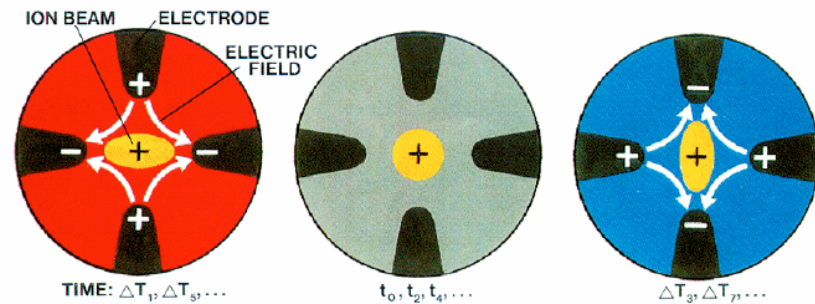





# Three historic lines of accelerators



CHESS & LEPP

Transformer Accelerator

Direct Voltage Accelerators Resonant Accelerators

- 1924: Wideroe invents the betatron
- 1940: Kerst and Serber build a betatron for 2.3MeV electrons and understand betatron (transverse) focusing (in 1942: 20MeV)

Betatron:

$R = \text{const}, B = B(t)$

Whereas for a cyclotron:

$R(t), B = \text{const}$

No acceleration section is needed since

$$\oint_{\partial A} \vec{E} \cdot d\vec{s} = - \iint_A \frac{d}{dt} \vec{B} \cdot d\vec{a}$$

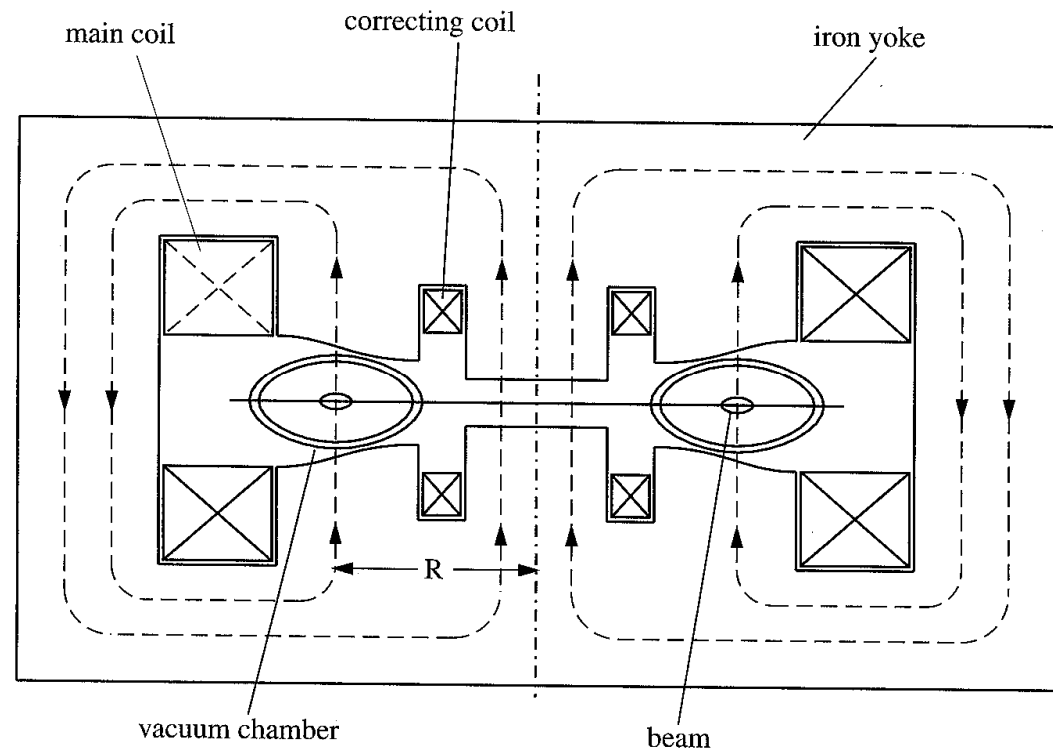



## The Betatron Condition



CHESS & LEPP

$$\text{Condition: } R = \frac{-p_\varphi(t)}{qB_z(R,t)} = \text{const.} \quad \text{given} \quad \oint_{\partial A} \vec{E} \cdot d\vec{s} = -\iint_A \frac{d}{dt} \vec{B} \cdot d\vec{a}$$

$$E_\varphi(R,t) = -\frac{1}{2\pi R} \int \frac{d}{dt} B_z(r,t) r dr d\varphi = -\frac{R}{2} \left\langle \frac{d}{dt} B_z \right\rangle$$

$$\frac{d}{dt} p_\varphi(t) = qE_\varphi(R,t) = -q \frac{R}{2} \left\langle \frac{d}{dt} B_z \right\rangle$$

$$p_\varphi(t) = p_\varphi(0) - q \frac{R}{2} [\langle B_z \rangle(t) - \langle B_z \rangle(0)] = -RqB_z(R,t)$$

$$B_z(R,t) - B_z(R,0) = \frac{1}{2} [\langle B_z \rangle(t) - \langle B_z \rangle(0)]$$

Small deviations from this condition lead to transverse beam oscillations called **betatron oscillations** in all accelerators.

- Today: Betatrons with typically about 20MeV for medical applications



# The Synchrotron



CHESS & LEPP

- 1945: Veksler (UDSSR) and McMillan (USA) invent the synchrotron
- 1946: Goward and Barnes build the first synchrotron (using a betatron magnet)
- 1949: Wilson et al. at Cornell are first to store beam in a synchrotron (later 300MeV, magnet of 80 Tons)
- 1949: McMillan builds a 320MeV electron synchrotron

- Many smaller magnets instead of one large magnet
- Only one acceleration section is needed, with

$$R = \frac{p(t)}{qB(R,t)} = \text{const.}$$

$$\omega = 2\pi \frac{v_{\text{particle}}}{L} n$$

for an integer  $n$  called the harmonic number

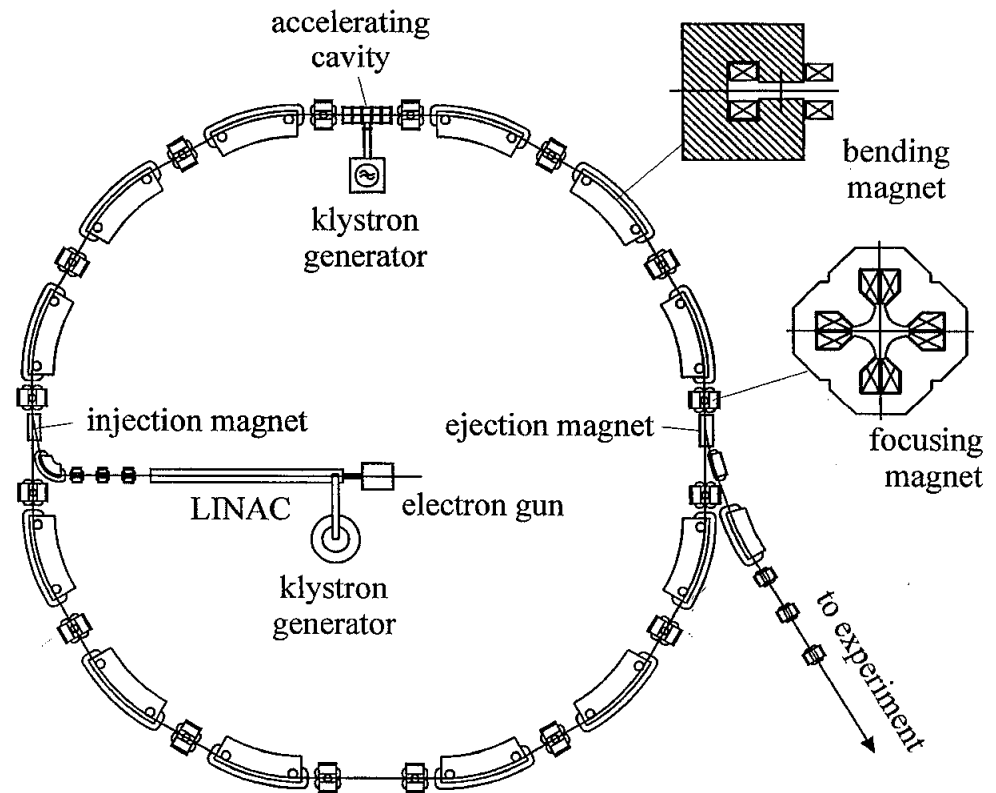



# Robert R Wilson, Architecture



CHESS & LEPP

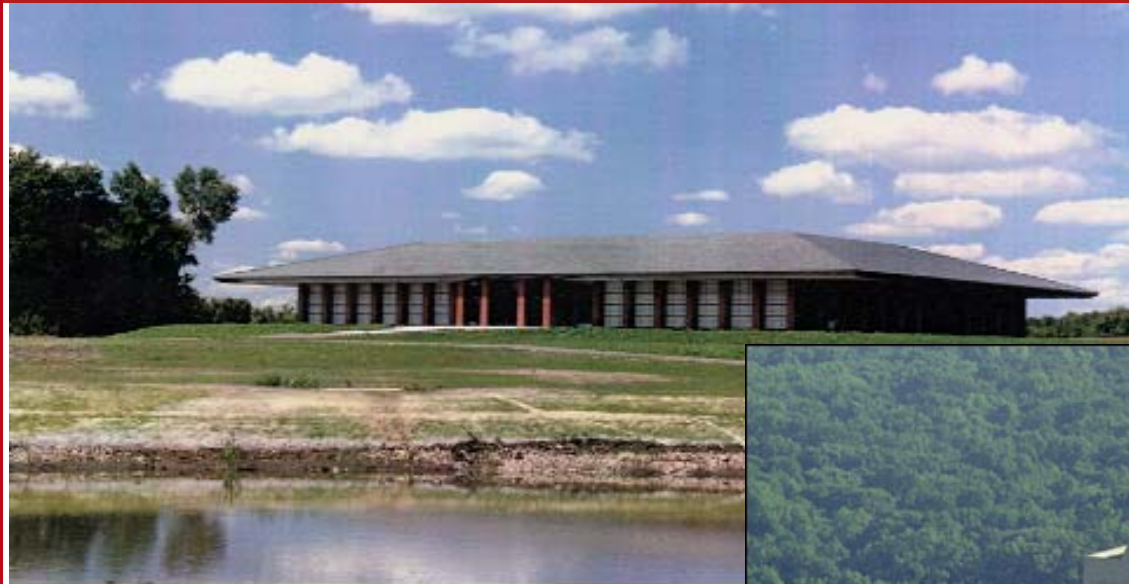

Science Ed Center, FNAL (1990)

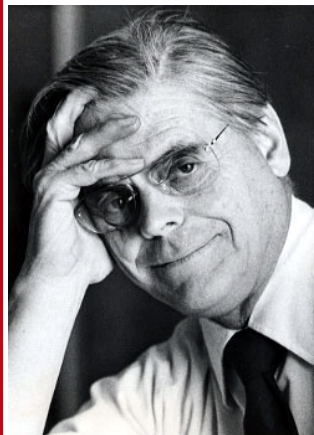

Robert R Wilson  
USA 1914-2000



Wilson Hall, FNAL



Broken symmetry

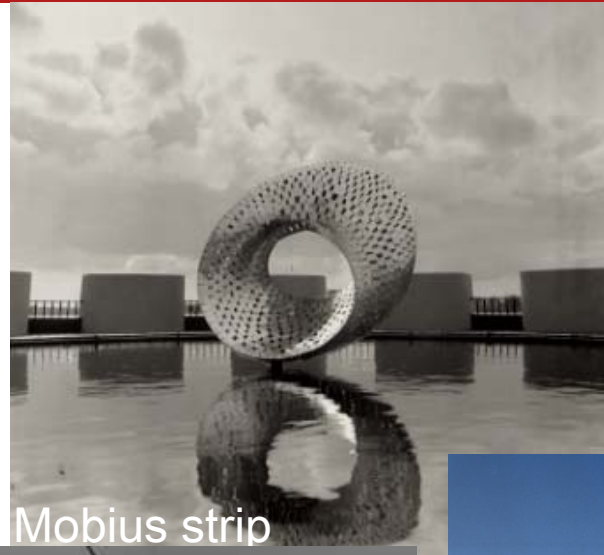

Mobius strip



Tractricious



$\pi$  lines



Hyperbolic obelisk



# Weak focusing Synchrotrons



CHESS & LEPP

- 1952: Operation of the Cosmotron, 3.3 GeV proton synchrotron at Brookhaven: Beam pipe height: 15cm.

Natural ring focusing:

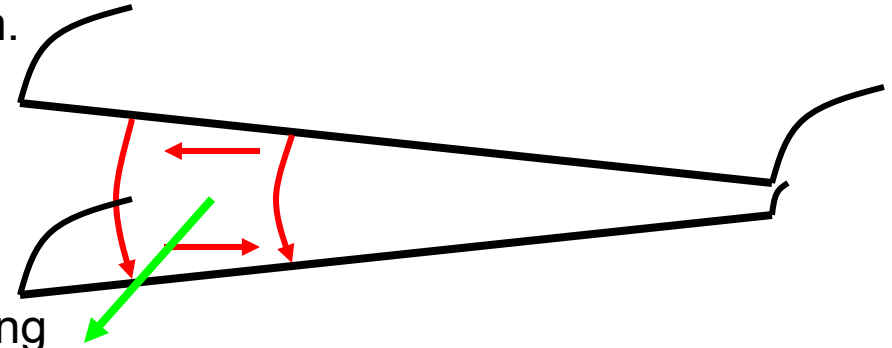
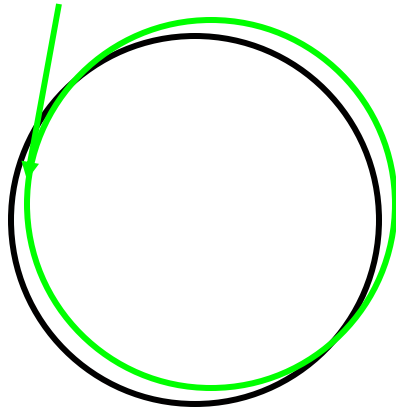

Vertical focusing  
+ Horizontal defocusing + ring focusing  
Focusing in both planes



The Cosmotron

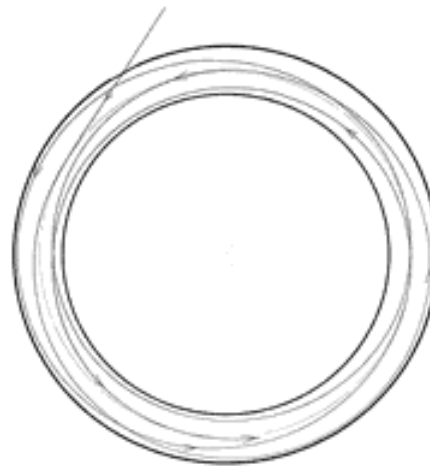

Weak focusing accelerator

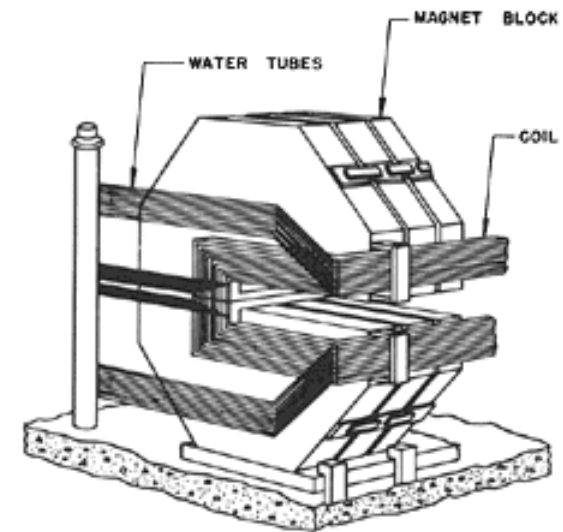



# Strong focusing Synchrotrons



CHESS & LEPP

- 1952: Courant, Livingston, Snyder publish about strong focusing
- 1954: Wilson et al. build first synchrotron with strong focusing for 1.1MeV electrons at Cornell, 4cm beam pipe height, only 16 Tons of magnets.
- 1959: CERN builds the PS for 28GeV after proposing a 5GeV weak focusing accelerator for the same cost (still in use)

Transverse fields defocus in one plane if they focus in the other plane.  
But two successive elements, one focusing the other defocusing,  
can focus in both planes:

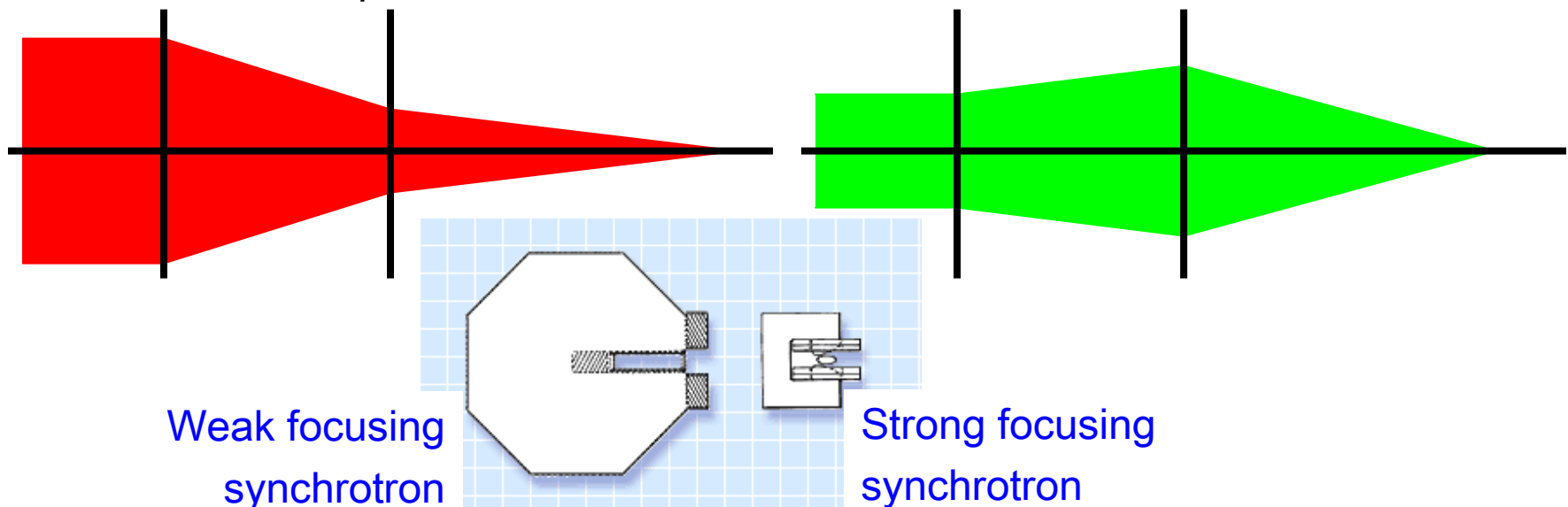

- Today: only strong focusing is used. Due to bad field quality at lower field excitations the injection energy is 20-500MeV from a linac or a microtron.



# Limits of Synchrotrons



CHESS & LEPP

$$\rho = \frac{p}{qB} \Rightarrow \text{The rings become too long}$$

Protons with  $p = 20 \text{ TeV}/c$ ,  $B = 6.8 \text{ T}$  would require a 87 km SSC tunnel  
 Protons with  $p = 7 \text{ TeV}/c$ ,  $B = 8.4 \text{ T}$  require CERN's 27 km LHC tunnel

$$P_{\text{radiation}} = \frac{c}{6\pi\epsilon_0} N \frac{q^2}{\rho^2} \gamma^4 \quad \Downarrow$$

Energy needed to compensate  
 Radiation becomes too large

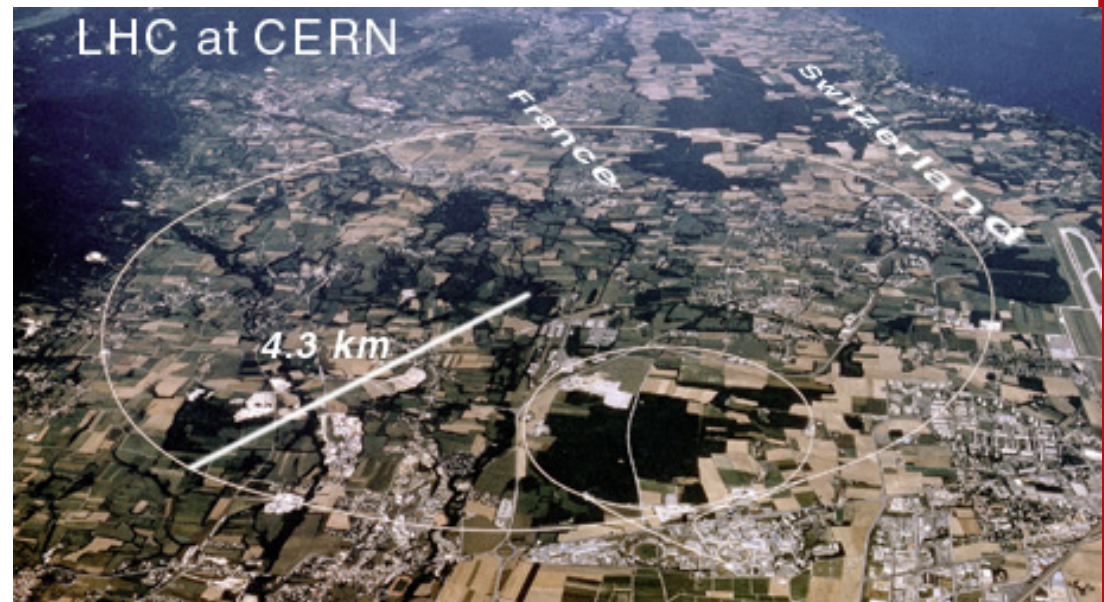

Electron beam with  $p = 0.1 \text{ TeV}/c$  in CERN's 27 km LEP tunnel radiated 20 MW  
 Each electron lost about 4 GeV per turn, requiring many of RF accelerating sections.





# Colliding Beam Accelerators



CHESS & LEPP

- 1961: First storage ring for electrons and positrons (AdA) in Frascati for 250MeV
- 1972: SPEAR electron positron collider at 4GeV. Discovery of the J/Psi at 3.097GeV by Richter (SPEAR) and Ting (AGS) starts the November revolution and was essential for the quarkmodel and chromodynamics.
- 1979: 5GeV electron positron collider CESR (designed for 8GeV)

Advantage:

More center of mass energy

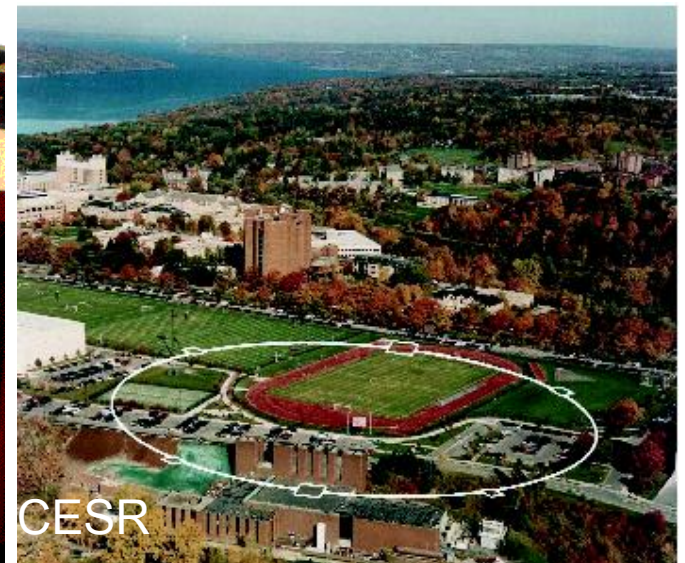
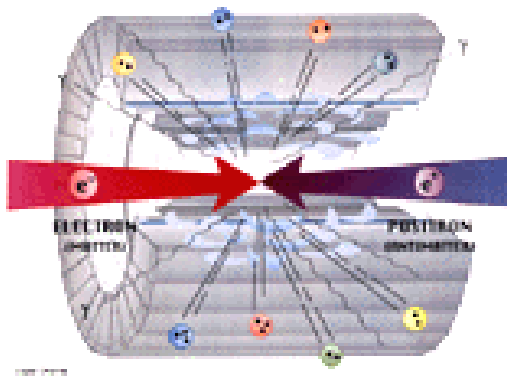

Drawback:

Less dense target

The beams therefore must be stored for a long time.



# Elements of a Collider



CHESS & LEPP

- Saving one beam while injection another
- Avoiding collisions outside the detectors.
- Compensating the forces between  $e^+$  and  $e^-$  beams

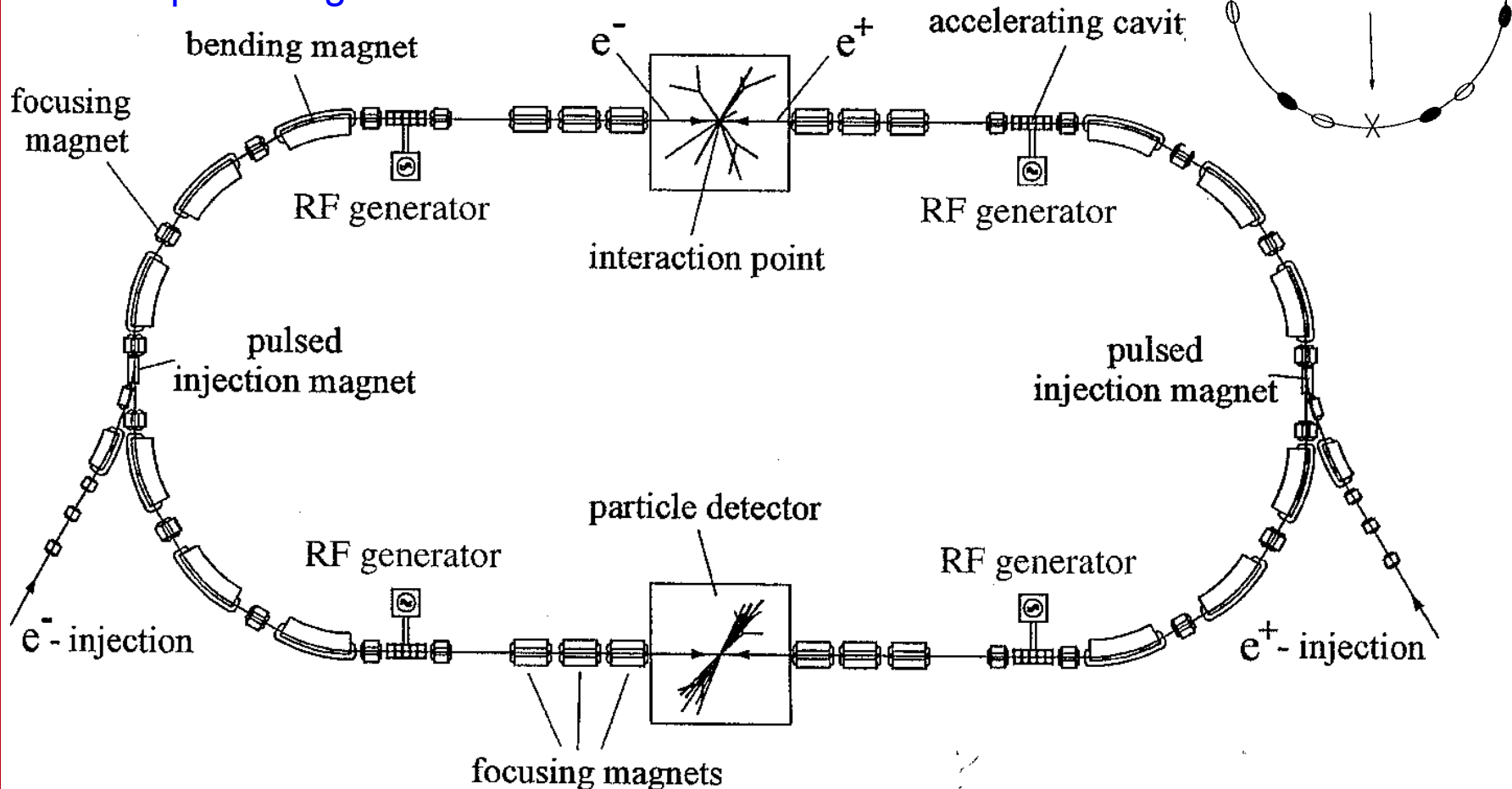



# Storage Rings



CHESS & LEPP

To avoid the loss of collision time during filling of a synchrotron, the beams in colliders must be stored for many millions of turns.

## Challenges:

- Required vacuum of pressure below  $10^{-7}$  Pa =  $10^{-9}$  mbar, 3 orders of magnitude below that of other accelerators.
- Fields must be stable for a long time, often for hours.
- Field errors must be small, since their effect can add up over millions of turns.
- Even though a storage ring does not accelerate, it needs acceleration sections for phase focusing and to compensate energy loss due to the emission of radiation.



## Further Development of Colliders



CHESS & LEPP

- 1981: Rubbia and van der Meer use stochastic cooling of antiprotons and discover  $W^+$ ,  $W^-$  and  $Z$  vector bosons of the weak interaction
- 1987: Start of the superconducting TEVATRON at FNAL
- 1989: Start of the 27km long LEP electron positron collider
- 1990: Start of the first asymmetric collider, electron (27.5GeV) proton (920GeV) in HERA at DESY
- 1998: Start of asymmetric two ring electron positron colliders KEK-B / PEP-II
- Today: 27km, 7 TeV proton collider LHC being build at CERN



NP 1984  
Carlo Rubbia  
Italy 1934 -



NP 1984  
Simon van der Meer  
Netherlands 1925 -





$$E = mc^2$$

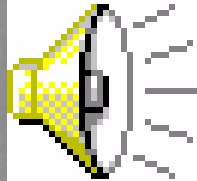
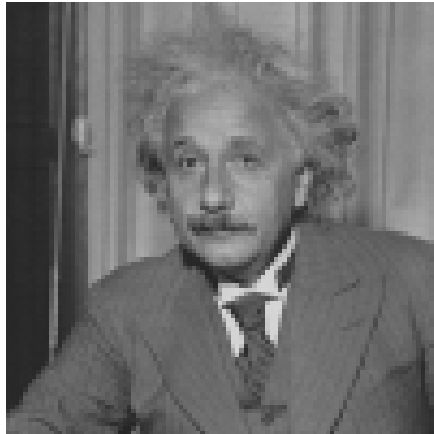

Albert Einstein, 1879-1955

Nobel Prize, 1921

Time Magazine Man of the Century

### Four-Vectors:

Quantities that transform according to the Lorentz transformation when viewed from a different inertial frame.

### Examples:

$$X^\mu \in \{ct, x, y, z\}$$

$$P^\mu \in \{\frac{1}{c}E, p_x, p_y, p_z\}$$

$$\Phi^\mu \in \{\frac{1}{c}\phi, A_x, A_y, A_z\}$$

$$J^\mu \in \{c\rho, j_x, j_y, j_z\}$$

$$K^\mu \in \{\frac{1}{c}\omega, k_x, k_y, k_z\}$$

$$X^\mu \in \{ct, x, y, z\} \Rightarrow X^\mu X_\mu = (ct)^2 - \vec{x}^2 = \text{const.}$$

$$P^\mu \in \{\frac{1}{c}E, p_x, p_y, p_z\} \Rightarrow P^\mu P_\mu = \left(\frac{E}{c}\right)^2 - \vec{p}^2 = (m_0c)^2 = \text{const.}$$



# Available Energy



CHESS &amp; LEPP

$$\begin{aligned}
 \frac{1}{c^2} E_{\text{cm}}^2 &= (P_1^\mu + P_2^\mu)_{\text{cm}} (P_{1\mu} + P_{2\mu})_{\text{cm}} \\
 &= (P_1^\mu + P_2^\mu)(P_{1\mu} + P_{2\mu}) \\
 &= \frac{1}{c^2} (E_1 + E_2)^2 - (p_{z1} - p_{z2})^2 \\
 &= 2\left(\frac{E_1 E_2}{c^2} + p_{z1} p_{z2}\right) + (m_{01} c)^2 + (m_{02} c)^2
 \end{aligned}$$

Operation of synchrotrons: fixed target experiments where some energy is in the motion of the center of mass of the scattering products

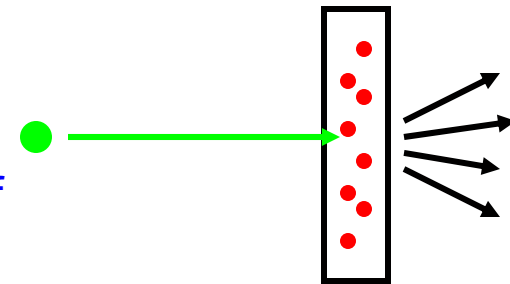

$$E_1 \gg m_{01} c^2, m_{02} c^2; p_{z2} = 0; E_2 = m_{02} c^2 \Rightarrow E_{\text{cm}} = \sqrt{2E_1 m_{02} c^2}$$

Operation of colliders:  
the detector is in the center of mass system

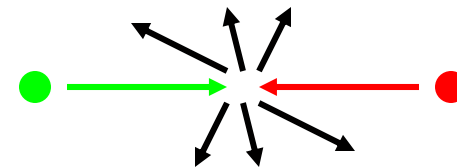

$$E_1 \gg m_{01} c^2; E_2 \gg m_{02} c^2 \Rightarrow E_{\text{cm}} = 2\sqrt{E_1 E_2}$$



# The Livingston Chart



CHESS & LEPP

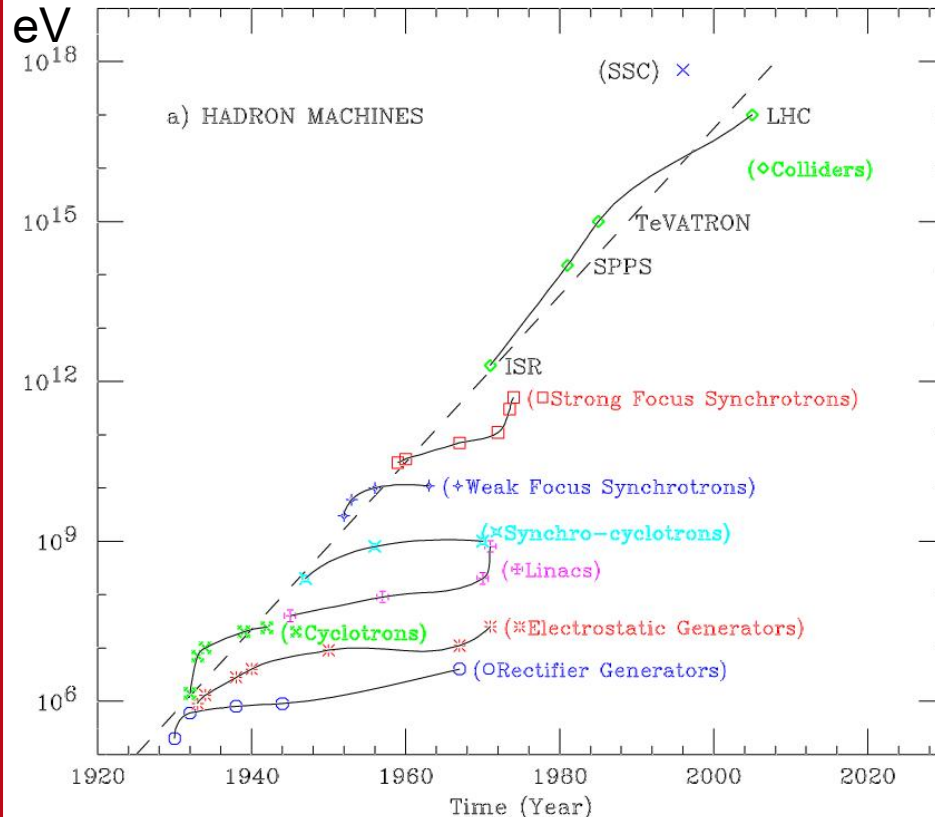

Comparison:  
highest energy cosmic rays  
have a few  $10^{20}$  eV

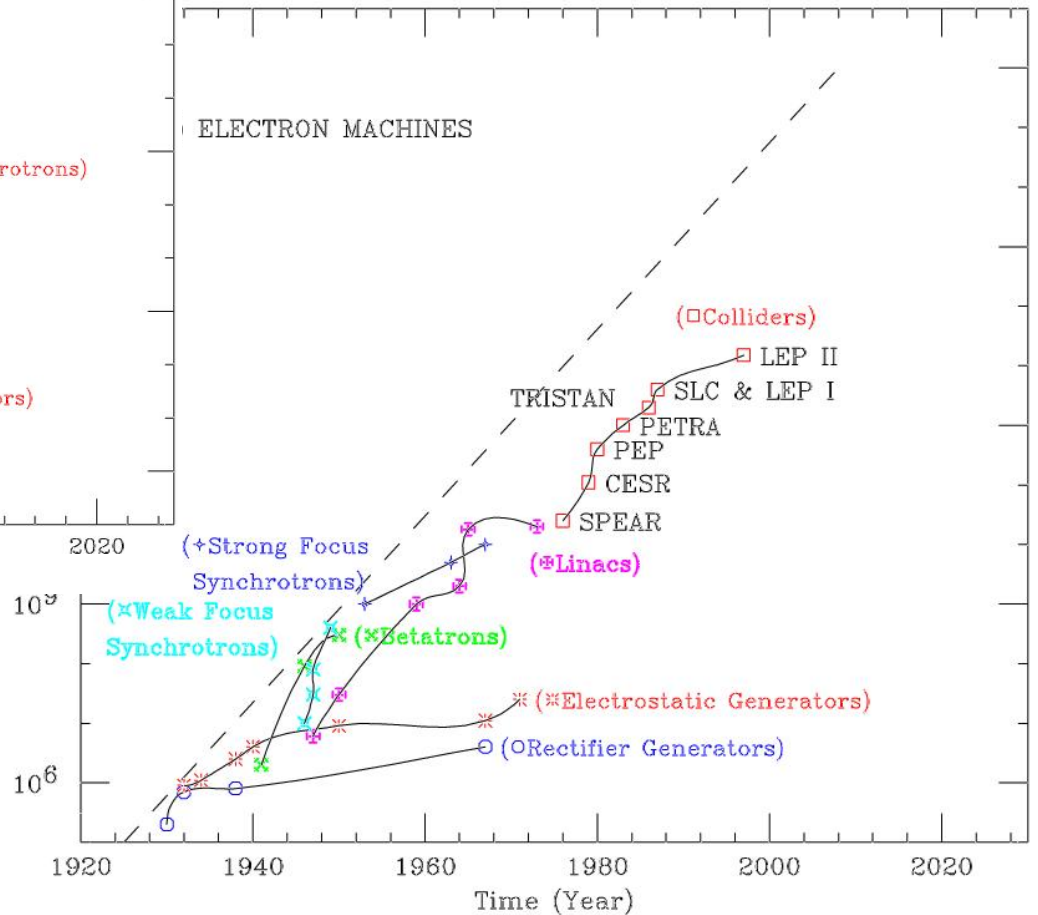

Energy that would be needed in a fixed target experiment versus the year of achievement

$$E_1 = \frac{E_{cm}^2}{2m_{02}c^2}$$



## Example: Production of the pbar



CHESS & LEPP

- 1954: Operation of Bevatron, first proton synchrotron for 6.2 GeV, production of the antiproton by Chamberlain and Segrè

$$p + p \mapsto p + p + p + \bar{p}$$

$$\frac{1}{c^2} E_{\text{cm}}^2 = 2\left(\frac{E_1 E_2}{c^2} + p_{z1} p_{z2}\right) + (m_{01} c)^2 + (m_{02} c)^2$$

$$(4m_{p0} c)^2 < \frac{1}{c^2} E_{\text{cm}}^2 = 2\frac{E_1 m_{p0}}{c^2} + (m_{p0} c)^2 + (m_{p0} c)^2$$

$$7m_{p0} c^2 < E_1$$

$$\underline{K_1 = E_1 - m_0 c^2} > \underline{6m_{p0} c^2 = 5.628 \text{ GeV}}$$



NP 1959

Emilio Gino Segrè

Italy 1905 – USA 1989



NP 1959

Owen Chamberlain

USA 1920 - 2006





## Example: $c$ - $\bar{c}$ states



CHESS & LEPP

- 1974: Observation of  $c - \bar{c}$  resonances ( $J/\Psi$ ) at  $E_{cm} = 3095\text{MeV}$  at the  $e^+/e^-$  collider SPEAR

$$\frac{1}{c^2} E_{cm}^2 = 2\left(\frac{E_1 E_2}{c^2} + p_{z1} p_{z2}\right) + (m_{01} c)^2 + (m_{02} c)^2$$

$$E_1 = E_2 \Rightarrow E_{cm}^2 = 4E^2$$

Energy per beam:  $K = E - m_0 c = \underline{1547\text{MeV}}$

Beam energy needed for an equivalent fixed target experiment:

$$\frac{E_{cm}^2}{c^2} = 2[Em + (mc)^2]$$

$$K = E - m_{0e} c^2 = \frac{E_{cm}^2 - 4(m_{0e} c^2)^2}{2m_{0e} c^2} = \underline{9.4\text{TeV}}$$



NP 1976  
Burton Richter  
USA 1931 -



NP 1976  
Samuel CC Ting  
USA 1936 -



## Rings for Synchrotron Radiation



CHESS & LEPP

- 1947: First detection of synchrotron light at General Electrics.
- 1952: First accurate measurement of synchrotron radiation power by Dale Corson with the Cornell 300MeV synchrotron.
- 1968: TANTALOS, first dedicated storage ring for synchrotron radiation



Dale Corson  
Cornell's 8<sup>th</sup> president  
USA 1914 –



## 3 Generations of Light Sources



CHESS & LEPP

- 1<sup>st</sup> Generation (1970s): Many HEP rings are parasitically used for X-ray production
- 2<sup>nd</sup> Generation (1980s): Many dedicated X-ray sources (light sources)
- 3<sup>rd</sup> Generation (1990s): Several rings with dedicated radiation devices (wigglers and undulators)
- Today (4<sup>th</sup> Generation): Construction of Free Electron Lasers (FELs) driven by LINACs

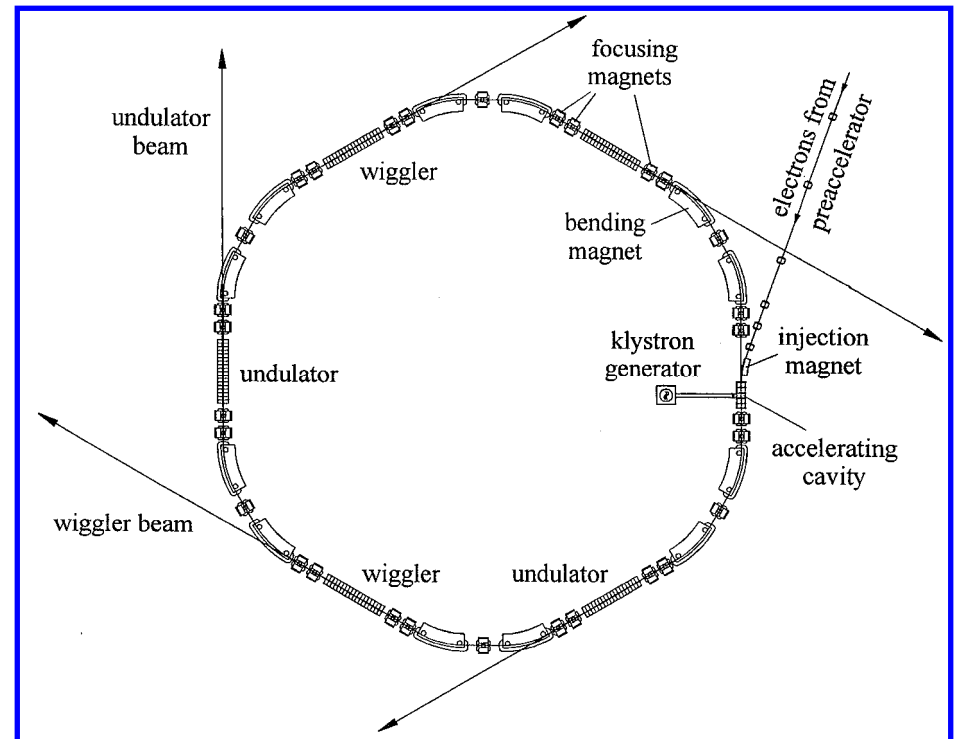
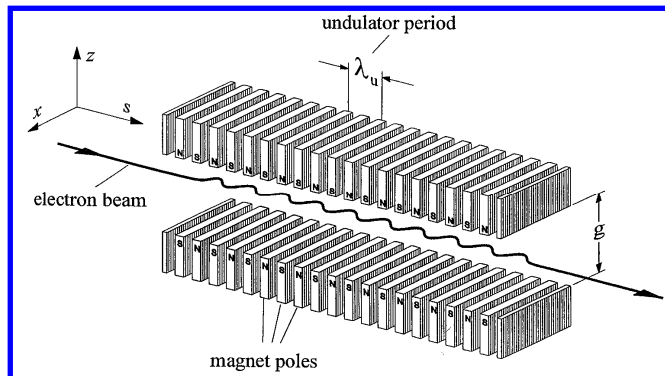
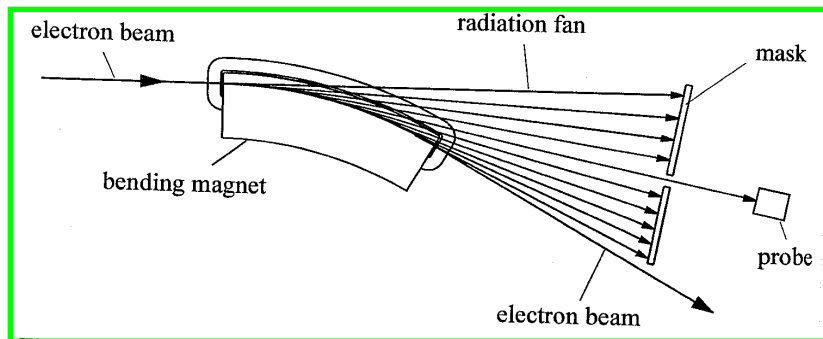



## Sorted by Location

### Europe

AGOR	Accelerateur Groningen-ORsay, <a href="#">KVI</a> Groningen, Netherlands
ANKA	Ångströmquelle Karlsruhe, Karlsruhe, Germany ( <a href="#">Forschungsgruppe Synchrotronstrahlung (FGS)</a> )
ASTRID	Aarhus Storage Ring in Denmark, <a href="#">ISA</a> , Aarhus, Denmark
BESSY	Berliner Elektronenspeicherring-Gesellschaft für Synchrotronstrahlung, Germany ( <a href="#">BESSY I status</a> , <a href="#">BESSY II status</a> )
BINP	Budker Institute for Nuclear Physics, Novosibirsk, Russian Federation ( <a href="#">VEPP-2M</a> collider, <a href="#">VEPP-4M</a> collider ( <a href="#">status</a> ))
CERN	Centre Europeen de Recherche Nucleaire, Geneva, Suisse ( <a href="#">LEP &amp; SPS</a> Status, <a href="#">LHC</a> , <a href="#">CLIC</a> , <a href="#">PS-Division</a> , <a href="#">SL-Division</a> )
COSY	Cooler Synchrotron, <a href="#">IKP</a> , <a href="#">FZ Jülich</a> , Germany ( <a href="#">COSY Status</a> )
CYCLONE	Cyclotron of Louvain la Neuve, Louvain-la-Neuve, Belgium
DELTA	Dortmund Electron Test Accelerator, U of Dortmund, Germany ( <a href="#">DELTA Status</a> )
DESY	Deutsches Elektronen Synchrotron, Hamburg, Germany ( <a href="#">HERA</a> , <a href="#">PETRA</a> and <a href="#">DORIS</a> status, <a href="#">TESLA</a> )
ELBE	ELectron source with high Brilliance and low Emittance, <a href="#">FZ Rossendorf</a> , Germany
ELETTRA	Trieste, Italy ( <a href="#">ELETTRA status</a> )
ELSA	Electron Stretcher Accelerator, Bonn University, Germany ( <a href="#">ELSA status</a> )
ESRF	European Synchrotron Radiation Facility, Grenoble, France ( <a href="#">ESRF status</a> )
GANIL	Grand Accélérateur National d'Ions Lourds, Caen, France
GSI	Gesellschaft für Schwerionenforschung, Darmstadt, Germany
IHEP	Institute for High Energy Physics, Protvino, Moscow region, Russian Federation
INFN	Istituto Nazionale di Fisica Nucleare, Italy, <a href="#">LNF</a> - Laboratori Nazionali di Frascati ( <a href="#">DAFNE</a> , <a href="#">other accelerators</a> ), <a href="#">LNL</a> - Laboratori Nazionali di Legnaro ( <a href="#">Tandem</a> , <a href="#">CN Van de Graaff</a> , <a href="#">AN 2000 Van de Graaff</a> ), <a href="#">LNS</a> - Laboratori Nazionali del Sud, Catania, ( <a href="#">Superconducting Collider &amp; Van de Graaff Tandem</a> )
ISIS	<a href="#">Rutherford Appleton Laboratory</a> , Oxford, U.K. ( <a href="#">ISIS Status</a> )
ISL	IonenStrahlLabor am <a href="#">HMI</a> , Berlin, Germany
JINR	Joint Institute for Nuclear Research, Dubna, Russian Federation ( <a href="#">U-200</a> , <a href="#">U-400</a> , <a href="#">U-400M</a> , <a href="#">Storage Ring</a> , <a href="#">LHE Synchrotron / Nuclotron</a> )
JYFL	Jyväskylä Yliopiston Fysiikan Laitos, Jyväskylä, Finland
KTH	Kungl Tekniska Högskola (Royal Institute of Technology), Stockholm, Sweden ( <a href="#">Alfén Lab electron accelerators</a> )



# Accelerators of the World



CHES & LEPP

<b>LMU/TUM</b>	Accelerator of <b>LMU</b> and <b>TU Muenchen</b> , Munich, Germany
<b>LURE</b>	Laboratoire pour l'Utilisation du Rayonnement Electromagnétique, Orsay, France ( <b>DCI</b> , <b>Super-ACO status</b> , <b>CLIO</b> )
<b>MAMI</b>	Mainzer Microtron, <b>Mainz U</b> , Germany
<b>MAX-Lab</b>	Lund University, Sweden
<b>MSL</b>	Manne Siegbahn Laboratory, Stockholm, Sweden ( <b>CRYRING</b> )
<b>NIKHEF</b>	Nationaal Instituut voor Kernfysica en Hoge-Energie Fysica, Amsterdam, Netherlands ( <b>AmPS closed</b> )
<b>PSI</b>	Paul Scherrer Institut, Villigen, Switzerland ( <b>PSI status</b> , <b>SLS under construction</b> )
<b>S-DALINAC</b>	Darmstadt University of Technology, Germany ( <b>S-DALINAC status</b> )
<b>SRS</b>	Synchrotron Radiation Source, <b>Daresbury Laboratory</b> , Daresbury, U.K. ( <b>SRS Status</b> )
<b>TSL</b>	The Svedberg Laboratory, Uppsala University, Sweden ( <b>CELSIUS</b> )
<b>TSR</b>	Heavy-Ion Test Storage Ring, Heidelberg, Germany

## North America

<b>88" Cycl.</b>	<b>88-Inch Cyclotron</b> , Lawrence Berkeley Laboratory ( <b>LBL</b> ), Berkeley, CA
<b>ALS</b>	Advanced Light Source, Lawrence Berkeley Laboratory ( <b>LBL</b> ), Berkeley, CA ( <b>ALS Status</b> )
<b>ANL</b>	Argonne National Laboratory, Chicago, IL (Advanced Photon Source <b>APS [status]</b> , Intense Pulsed Neutron Source <b>IPNS [status]</b> , Argonne Tandem Linac Accelerator System <b>ATLAS</b> )
<b>BNL</b>	Brookhaven National Laboratory, Upton, NY ( <b>AGS</b> , <b>ATF</b> , <b>NLSL</b> , <b>RHIC</b> )
<b>CAMD</b>	Center for Advanced Microstructures and Devices
<b>CHES</b>	Cornell High Energy Synchrotron Source, <b>Cornell University</b> , Ithaca, NY
<b>CLS</b>	Canadian Light Source, <b>U of Saskatchewan</b> , Saskatoon, Canada
<b>CESR</b>	Cornell Electron-positron Storage Ring, Cornell University, Ithaca, NY ( <b>CESR Status</b> )
<b>FNAL</b>	Fermi National Accelerator Laboratory, Batavia, IL ( <b>Tevatron</b> )
<b>IAC</b>	Idaho accelerator center, Pocatello, Idaho
<b>IUCF</b>	Indiana University Cyclotron Facility, Bloomington, Indiana
<b>JLab</b>	aka TJNAF, Thomas Jefferson National Accelerator Facility (formerly known as CEBAF), Newport News, VA
<b>LAC</b>	Louisiana Accelerator Center, U of Louisiana at Lafayette, Louisiana
<b>LANL</b>	Los Alamos National Laboratory
<b>MIT-Bates</b>	Bates Linear Accelerator Center, Massachusetts Institute of Technology ( <b>MIT</b> )
<b>NSCL</b>	National Superconducting Cyclotron Laboratory, Michigan State University
<b>ORNL</b>	Oak Ridge National Laboratory ( <b>EN Tandem Accelerator</b> ), Oak Ridge, Tennessee
<b>SBSL</b>	Stony Brook Superconducting Linac, State University of New York ( <b>SUNY</b> )
<b>SLAC</b>	Stanford Linear Accelerator Center ( <b>Linac</b> , <b>NLC</b> - Next Linear Collider, <b>PEP</b> - Positron Electron Project (finished), <b>PEP-II</b> - asymmetric B Factory (in commissioning), <b>SLC</b> - SLAC Linear electron positron Collider, <b>SPEAR</b> - Stanford Positron Electron Asymmetric Ring (actually SPEAR-II, see SSRL), <b>SSRL</b> - Stanford Synchrotron Radiation Laboratory)
<b>SNS</b>	Spallation Neutron Source, Oak Ridge, Tennessee
<b>SRC</b>	Synchrotron Radiation Center, U of Wisconsin - Madison ( <b>Aladdin Status</b> )

<b>SURF II</b>	Synchrotron Ultraviolet Radiation Facility, National Institute of Standards and Technology ( <b>NIST</b> ), Gaithersburg, Maryland
<b>TASCC</b>	Tandem Accelerator Superconducting Cyclotron (Canada) ( <b>closed</b> )
<b>TRIUMF</b>	TRI-University Meson Facility / National Meson Research Facility, Vancouver, BC (Canada)

## South America

<b>LNLS</b>	Laboratorio Nacional de Luz Sincrotron, Campinas SP, Brazil
<b>TANDAR</b>	Tandem Accelerator, Buenos Aires, Argentina

## Asia

<b>BEPC</b>	Beijing Electron-Positron Collider, Beijing, China
<b>KEK</b>	National Laboratory for High Energy Physics ("Koh-Ene-Ken"), Tsukuba, Japan ( <b>KEK-B</b> , <b>PF</b> , <b>JLC</b> )
<b>NSC</b>	Nuclear Science Centre, New Delhi, India ( <b>15 UD Pelletron Accelerator</b> )
<b>PLS</b>	Pohang Light Source, Pohang, Korea
<b>RIKEN</b>	Institute of Physical and Chemical Research ("Rikagaku Kenkyusho"), Hiroswa, Wako, Japan
<b>SESAME</b>	Synchrotron-light for Experimental Science and Applications in the Middle East, Jordan (under construction)
<b>SPring-8</b>	Super Photon ring - 8 GeV, Japan
<b>SRRC</b>	Synchrotron Radiation Research Center, Hsinchu, Taiwan ( <b>SRRC Status</b> )
<b>UVSOR</b>	Ultraviolet Synchrotron Orbital Radiation Facility, Japan
<b>VECC</b>	Variable Energy Cyclotron, Calcutta, India

## Africa

<b>NAC</b>	National Accelerator Centre, Cape Town, South Africa
------------	--

## Sorted by Accelerator Type

### Electrons

### Stretcher Ring/Continuous Beam facilities

ELSA (Bonn U), JLab, MAMI (Mainz U), MAX-Lab, MIT-Bates, PSR (SAL), S-DALINAC (TH Darmstadt), SLAC



## Synchrotron Light Sources

ANKA (FZK), ALS (LBL), APS (ANL), ASTRID (ISA), BESSY, CAMD (LSU), CHESS (Cornell Wilson Lab), CLS (U of Saskatchewan), DELTA (U of Dortmund), ELBE (FZ Rossendorf), Elettra, ELSA (Bonn U), ESRF, HASYLAB (DESY), LURE, MAX-Lab, LNLS, NSLS (BNL), PF (KEK), UVSOR (IMS), PLS, S-DALINAC (TH Darmstadt), SESAME, SLS (PSI), SPEAR (SSRL, SLAC), SPring-8, SRC (U of Wisconsin), SRRC, SRS (Daresbury), SURF II (NIST)

## Other

Alfén Lab (KTH), IAC

## Protons

88" Cyclotron (LBL), CELSIUS (TSL), COSY (FZ Jülich), IPNS (ANL), ISL (HMI), ISIS, IUCF, LHC (CERN), NAC, PS (CERN), PSI, SPS (CERN)

## Light and Heavy Ions

88" Cyclotron (LBL), AGOR, ASTRID (ISA), ATLAS (ANL), CELSIUS (TSL), CRYRING (MSL), CYCLONE, EN Tandem (ORNL), GANIL, GSI, ISL (HMI), IUCF, JYFL, LAC, LHC (CERN), LHE Synchrotron / Nuclotron (JINR), LMU/TUM, LNL (INFN), LNS (INFN), NAC, NSC, PSI, RHIC (BNL), SBSL, SNS, SPS (CERN), TANDAR, TSR, U-200 / U-400 / U-400M / Storage Ring (JINR), VECC

## Collider

BEPC, CESR, DAFNE (LNF), HERA (DESY), LEP (CERN), LHC (CERN), PEP / PEP-II (SLAC), SLC (SLAC), KEK-B (KEK), TESLA (DESY), Tevatron (FNAL), VEPP-2M, VEPP-4M (BINP)



# The Future



CHES & LEPP

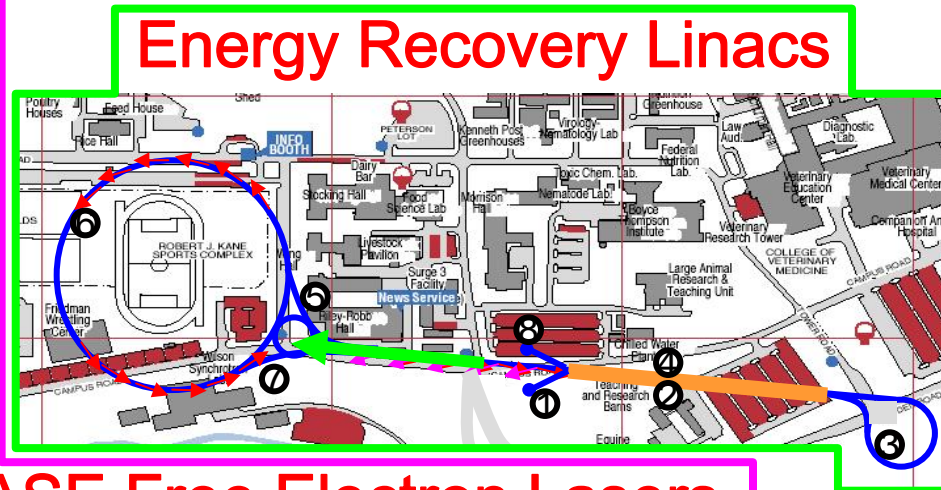
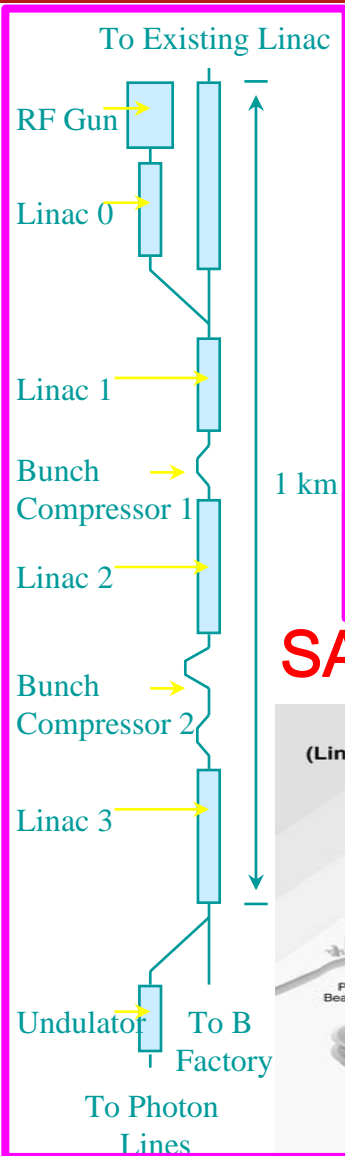

## SASE Free Electron Lasers

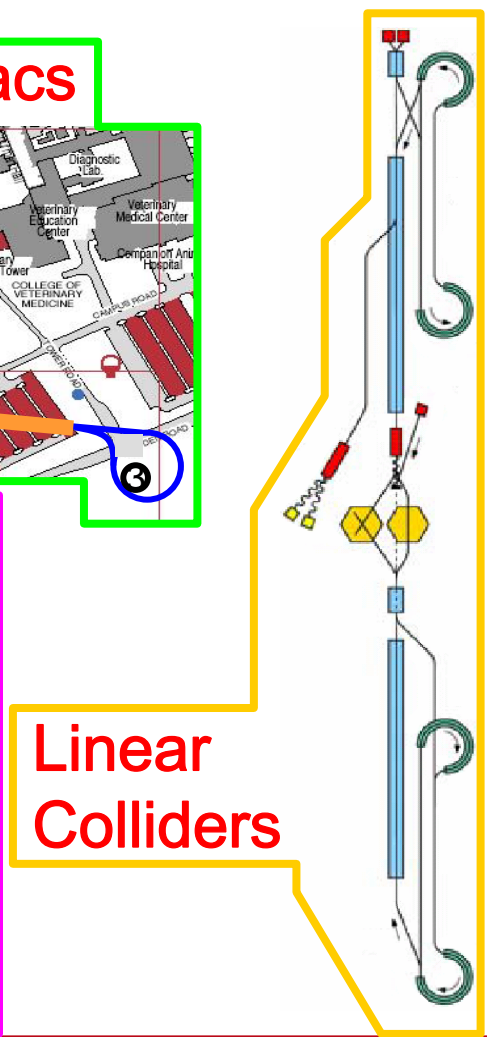
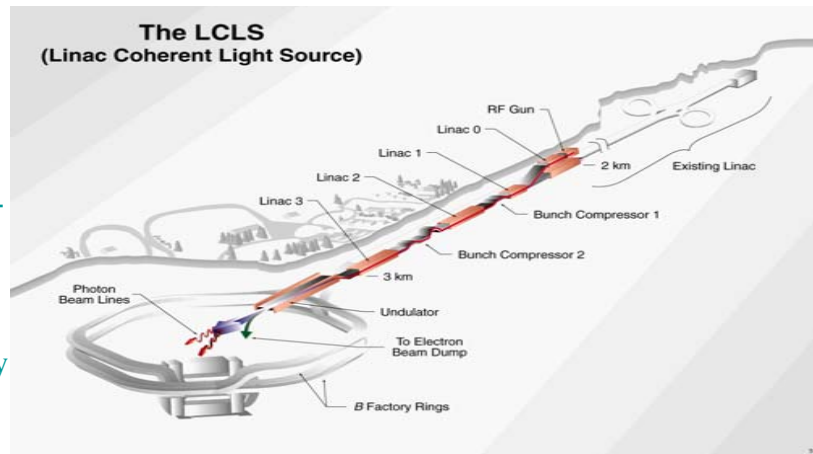

## Linear Colliders