

# Endplate for the LCTPC Large Prototype Endplate

D. Peterson, Cornell University

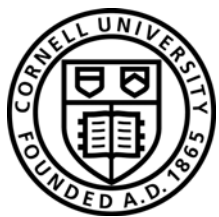
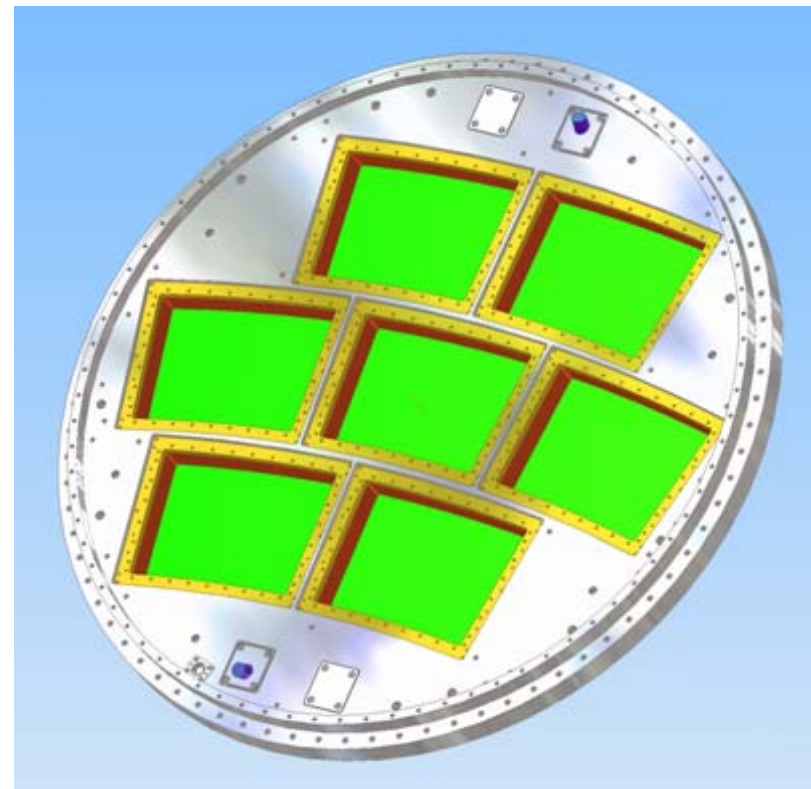

This project is supported, in part, by the US National Science Foundation (LCDRD award). This project is in collaboration with LC-TPC.

The endplate is part of a collaborative effort to evaluate several readout technologies for a TPC being developed as the main tracking device of an ILC detector:  
Micromegas, GEM, pixel.

Goals: Provide a framework on which one can interchange modules using the various technologies with minimal disruption to the other parts of the experiment, in particular the field cage.

Provide experimenters with mechanical components that allow implementation of different modules in the endplate.

For reconstruction development, provide a geometry that resembles the radial geometry of the final detector.

For calibration development, provide a precision frame which will allow investigation of techniques of the calibration of the magnetic field uniformity.

Investigate a particular design idea – an idea that could evolve into a low radiating material design.

Time line:

2005-11 Vienna: expression of interest of groups to build the large prototype

2006-01 Cornell: raising the interest within Cornell

2006-04 Berkeley: initial ideas for the panel geometry

2006-07 Vancouver: the mullions frame takes shape

2006-11 Valencia: endplate stiffness,  
details of holding panels  
start of the stress relief tests

2007-06 DESY: The module backframe size is defined,  
the stress relief process is defined.

2007-10 Fermilab: Final fieldcage/ geometry is defined.  
Proceed with initial backframes for modules  
Start vendor search.

2008-02 Ithaca: ship initial backframes, made at Cornell

2008-05 Ithaca: vendor cuts metal on endplate

2008-06 Ithaca: initial deliver of completed endplates

2008-08 Ithaca: precision correction complete,  
delivered to DESY

2008-10 DESY: endplate mounted on fieldcage.

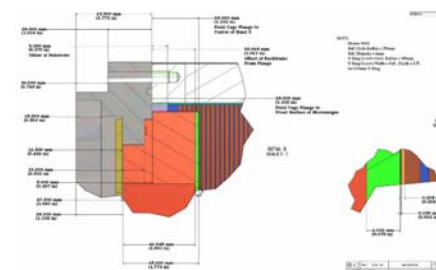
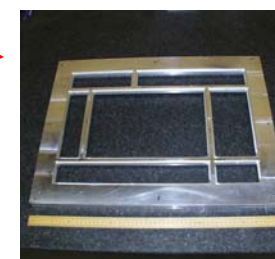
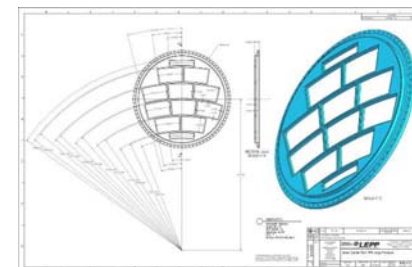

There are provisions for 7 identical detector modules.

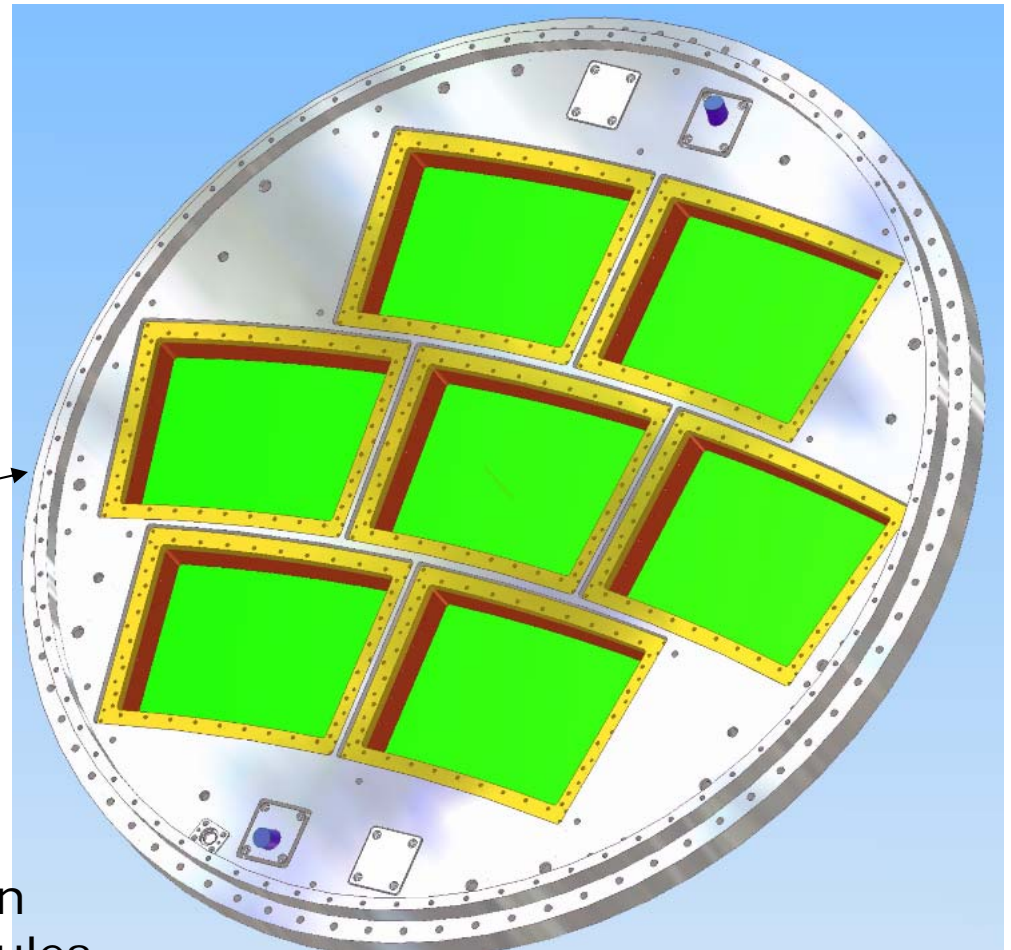
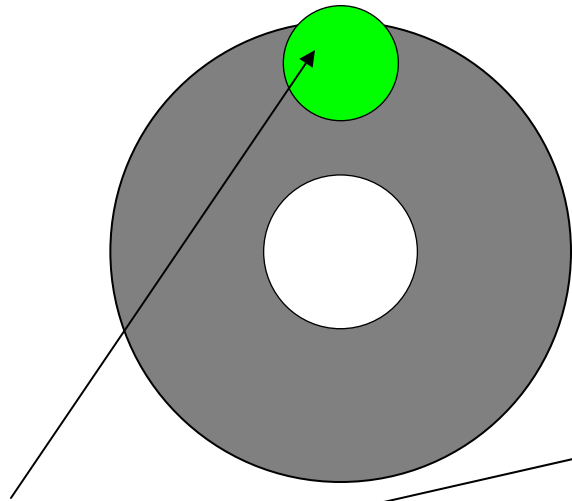

The “Large Prototype” endplate is designed as a section of a proposed TPC for the ILC.

This facilitates the goal of investigation of track reconstruction in that detector. (Although all modules have identical geometry; layers have “common radius of curvature”.

The endplate design has readout modules mounted and sealed on thin structural frame members; the basic structural element between modules is the "mullions".

module "backframe", provided with the endplate.

"mounting bracket", locates the module and compresses the o-ring, provided with the endplate

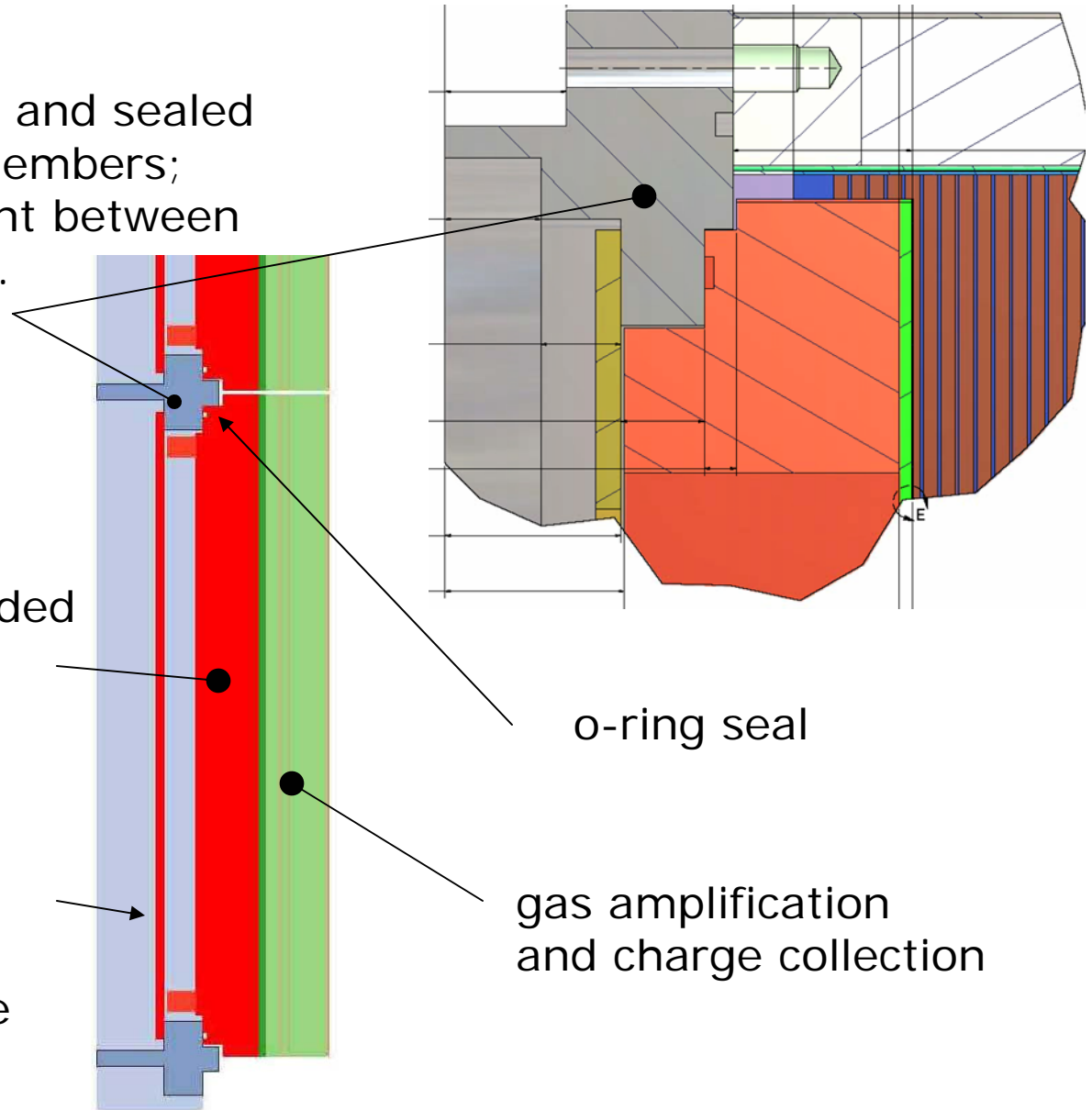

Inside

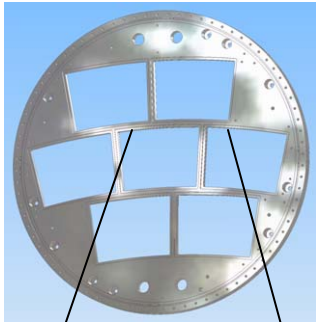

Outside

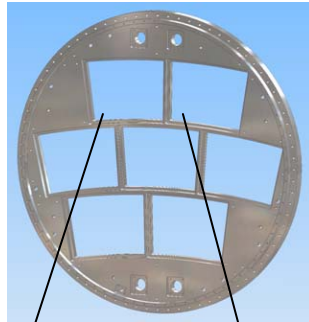

Modules are located by dowel pins that fit into **precision holes** in the outside surface of the plate.

The framework locates the holes and provides the sealing surface for the modules.

This frame must not deflect with the small over-pressure of the chamber gas (2mBar), locate the holes with 25 $\mu$ m accuracy, and be stable over time.

Simply machining the structure will not provide this.

dowel pin hole

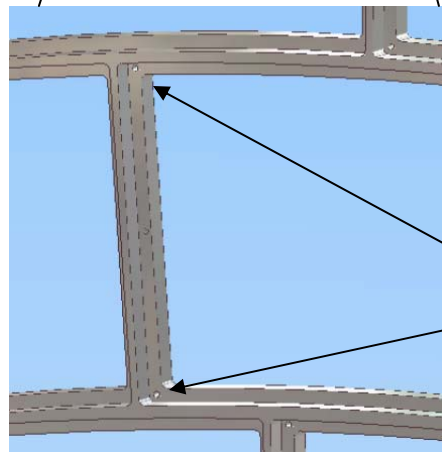
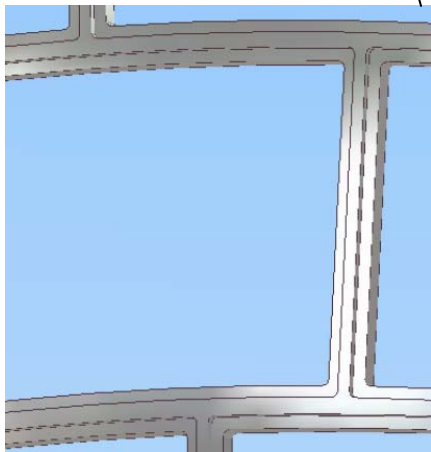



Manufacturing processes were evaluated with a series of identical test plates having mullions similar to those in the endplate.

Test plates were measured at each step in a Coordinate Measuring Machine.

Tested vibration treatment, heat treatment, and cold-shock (liquid nitrogen).

Selected process with the most success providing the dimensional tolerance:

*machine leaving a 0.75mm skin, cold shock in liquid nitrogen, machine leaving a 0.25mm skin, cold shock in liquid nitrogen, machine to final dimensions.*

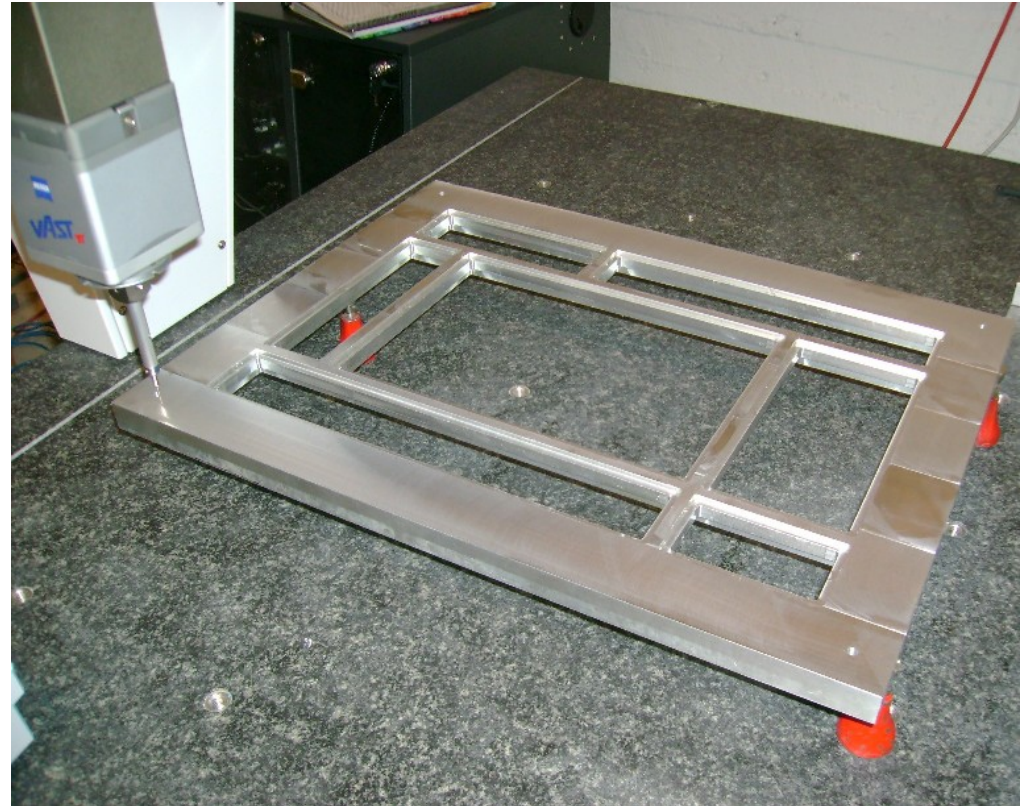

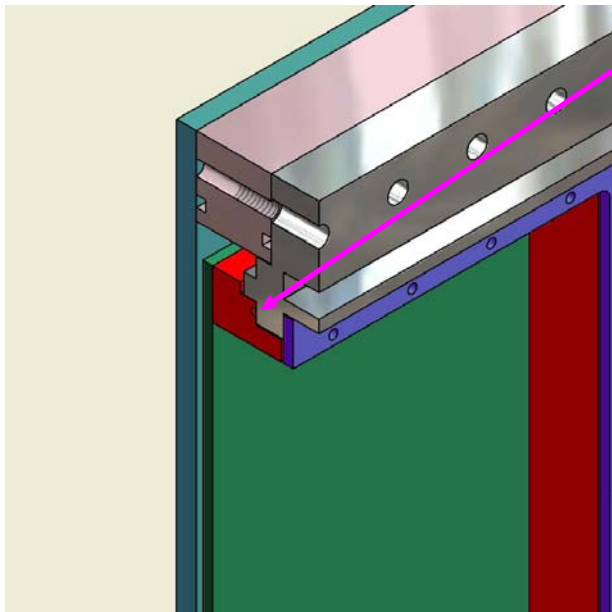
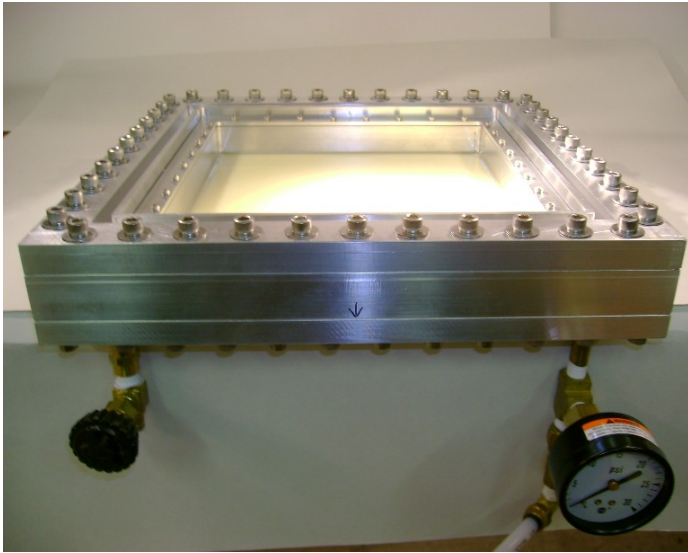

The gas seal is provided by an o-ring. Long-term tests of the o-ring configuration showed no pressure change in over 1 year.

A tested plate was measured under load in the Coordinate Measuring Machine with the result that the deflection will be  $7\mu\text{m}$  with 2.6milliBar chamber over pressure.



Endplates were produced with the 3-step machining process.

Measurements of the dowel pins holes positions showed a typical tolerance of  $\pm 15\mu\text{m}$  with a few excursions to  $\pm 30\mu\text{m}$ .

Some of the side surfaces varied from the design positions by as much as  $150\mu\text{m}$ .



In these cases, the surfaces were re-machined to correct the error. There was no warping of the mullions when this material was removed.



A series of module backframes were produced for various planned experiments (varying only in length):  
Micromegas (8)  
double-GEM with gate (8)  
triple-GEM without gate (1)  
GEM with pixel readout (2)  
dummy modules (14).

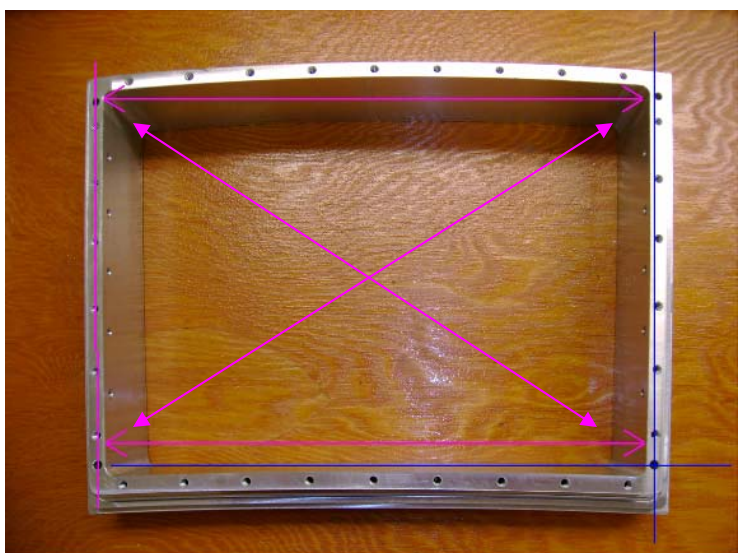

These were produced with the 3-step machining process.

About half of the module backframe required a 4<sup>th</sup> machining step to bring them into  $\pm 25\mu\text{m}$  tolerance.

The finished product:

Inside the chamber



Field cage termination

Laser input

alignment light input

Outside the chamber

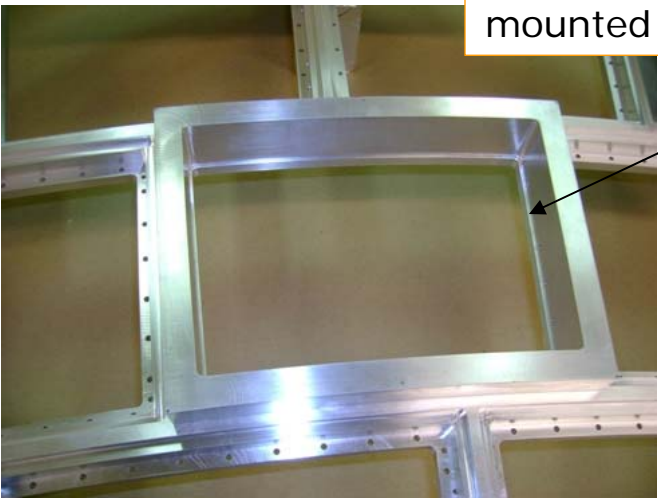
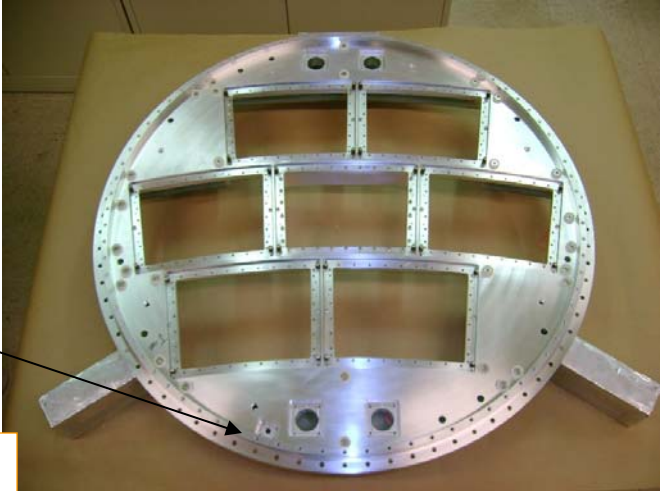

mounted "module backframe"

"mounting bracket"

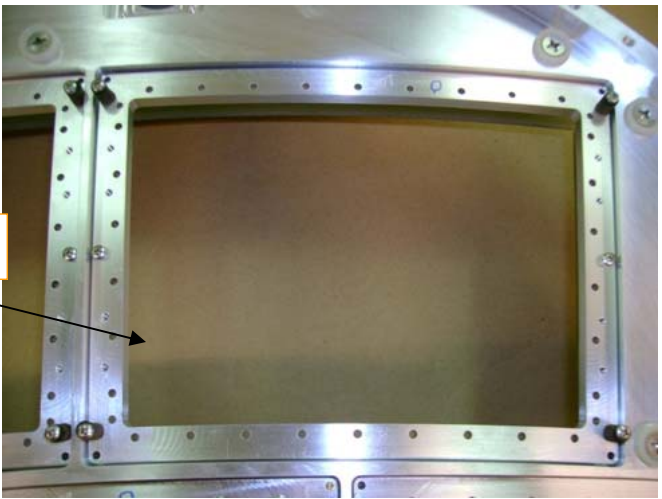



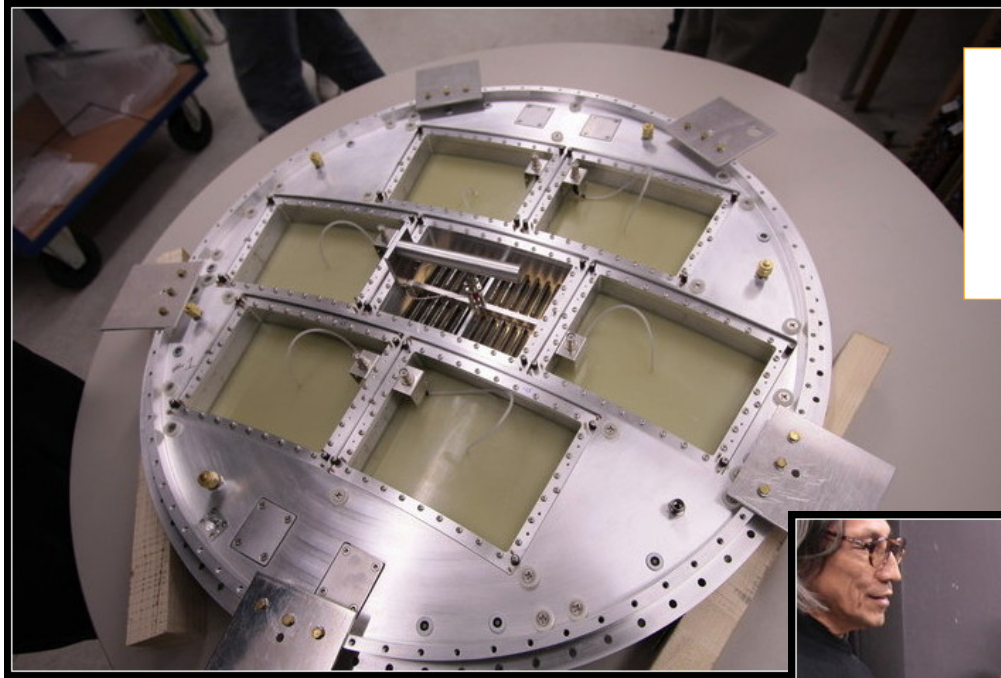

30-October-2008,  
Endplate, fully assembled,  
with Micromegas module  
in center location.

30-October-2008  
The leak test, on the field cage:  
With 42 o-rings, and 8 pipe threads,  
the leak test passed,  
requiring much more than  
my prediction.

