

# The Cornell ERL Project

Georg Hoffstaetter ( LEPP )

for the ERL endeavor

B.Barstow, I.V.Bazarov, S.Belomestnykh, D.Bilderback, J.Brock,  
K.Finkelstein, S.Gruner, G.H.Hoffstaetter, Alex Kazimirov, M.Liepe, Y.Lin,  
H.Padamsee, D.Sagan, V.Shemelin, Qun Shen, C.Sinclair, R.Talman,  
M.Tigner, V.Veshcherevich

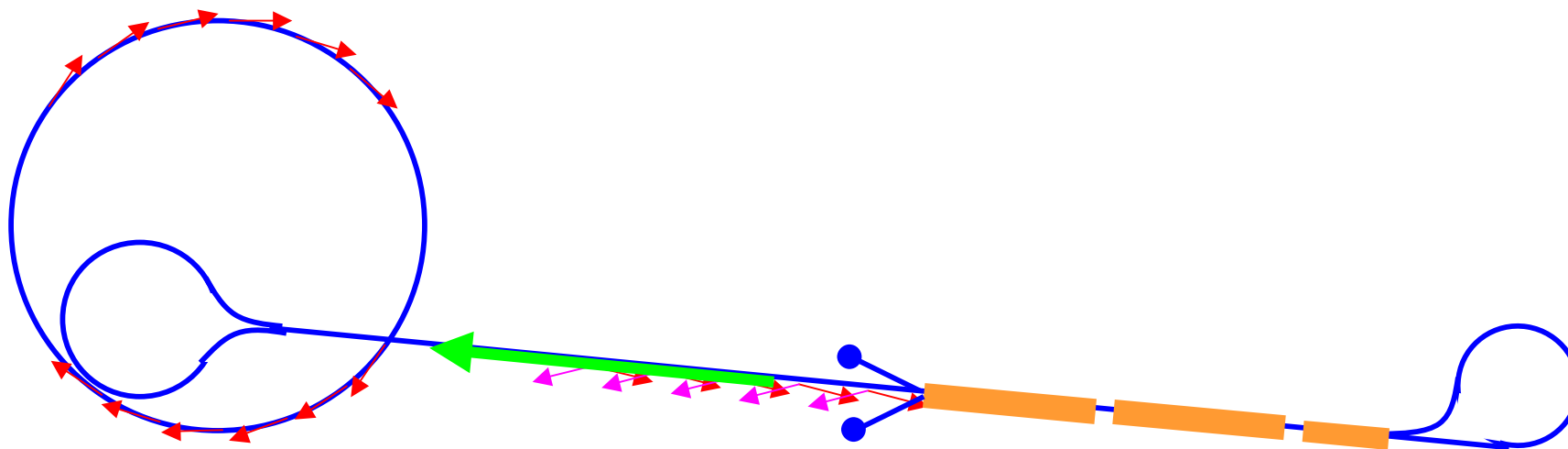

# Could an ERL use the CESR tunnel

03/23/2004

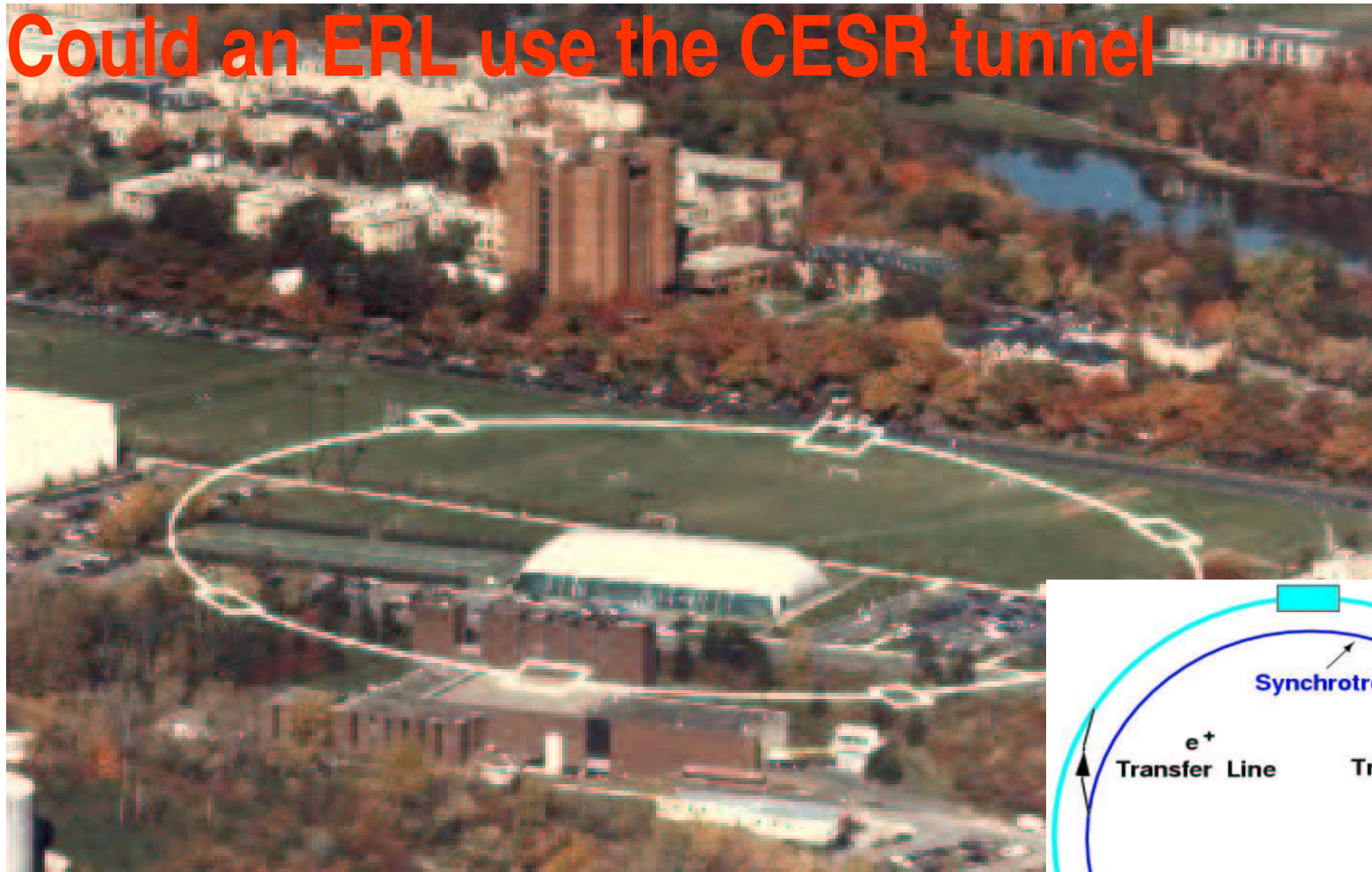

- 1 An extension of the tunnel could easily conflict with buildings
- 1 But the tunnel sealing is at about 836 ft ASL whereas
- 1 The base of the deepest relevant building's foundation is at 862ft ASL, yielding about 10m of space.

CORNELL

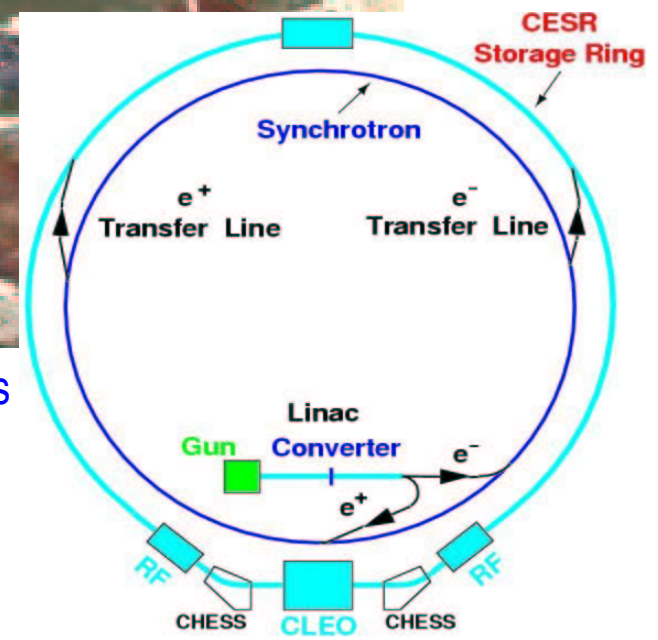

Georg.Hoffstaetter@Cornell.edu

# Synchrotron Radiation @ Cornell

03/23/2004

- 1 1947: **1<sup>st</sup>** detection of synchrotron light at General Electrics. Soon advised by D.H.Tombouliau (Cornell University)
- 1 1952: **1<sup>st</sup>** accurate measurement of synchrotron radiation power by Dale Corson with the Cornell 300MeV synchrotron.
- 1 1953: **1<sup>st</sup>** measurement of the synchrotron radiation spectrum by Paul Hartman with the Cornell 300MeV synchrotron.
- 1 Worlds **1<sup>st</sup>** synchrotron radiation beam line (Cornell 230MeV synch.)
- 1 1961: **1<sup>st</sup>** measurement of radiation polarization by Peter Joos with the Cornell 1.1GeV synchrotron.
- 1 1978: X-Ray facility CHESS is being build at CESR
- 1 2003: **1<sup>st</sup>** Nobel prize with CESR data goes to R.MacKinnon



Dale Corson  
Cornell's 8<sup>th</sup> president

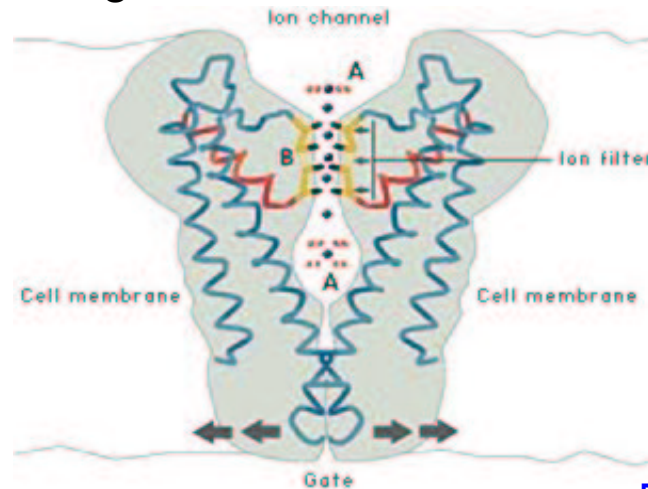

Roderick MacKinnon

# Beam size in a linear accelerator

The beam properties are to a very large extent determined by the injector system:

- 1 The horizontal beam size can be made much smaller than in a ring
- 1 While the smallest beams that are possible in rings have almost been reached, a linear accelerator can **take advantage of any future improvement** in the electron source or injector system.

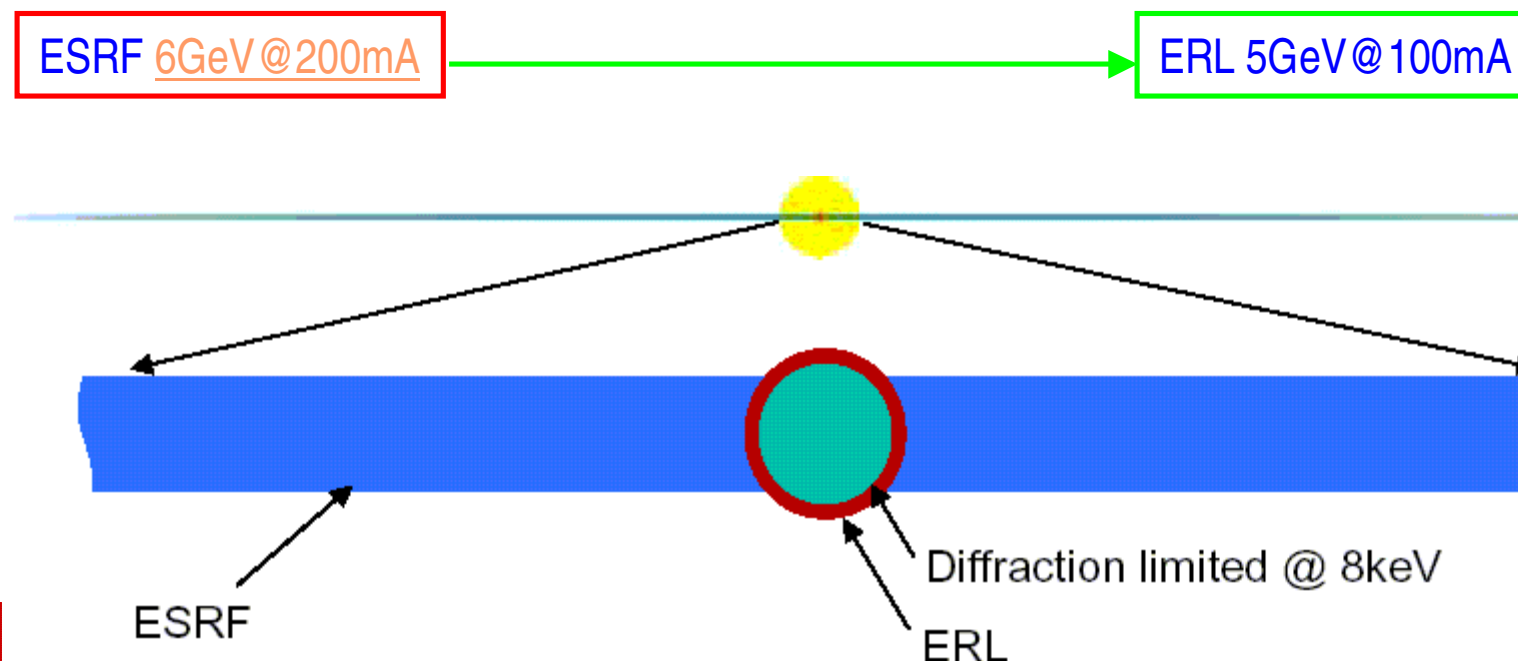

# Smaller Beam $\rightarrow$ more Coherence

- Coherent x-ray diffraction imaging
- It would, in principle, allow atomic resolution imaging on non-crystalline materials.
- This type of experiments is completely limited by coherent flux.

Factor 100 more coherent flux for ERL  
for same x-rays, or provide coherence for harder x-rays

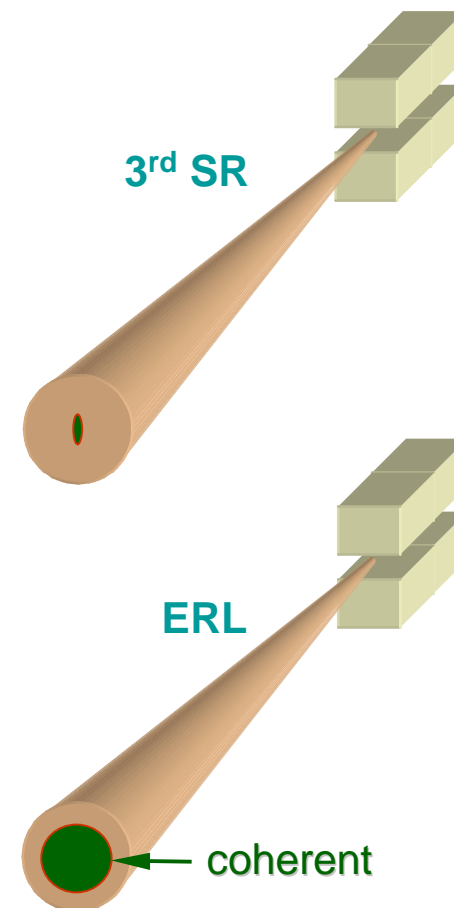

# Bunch length in a linac

- 1 The bunch length can be made much smaller than in a ring
- 1 While the shortest bunches possible in rings have almost been reached, a linear accelerator can take advantage of any future improvement in the source source or injector system.

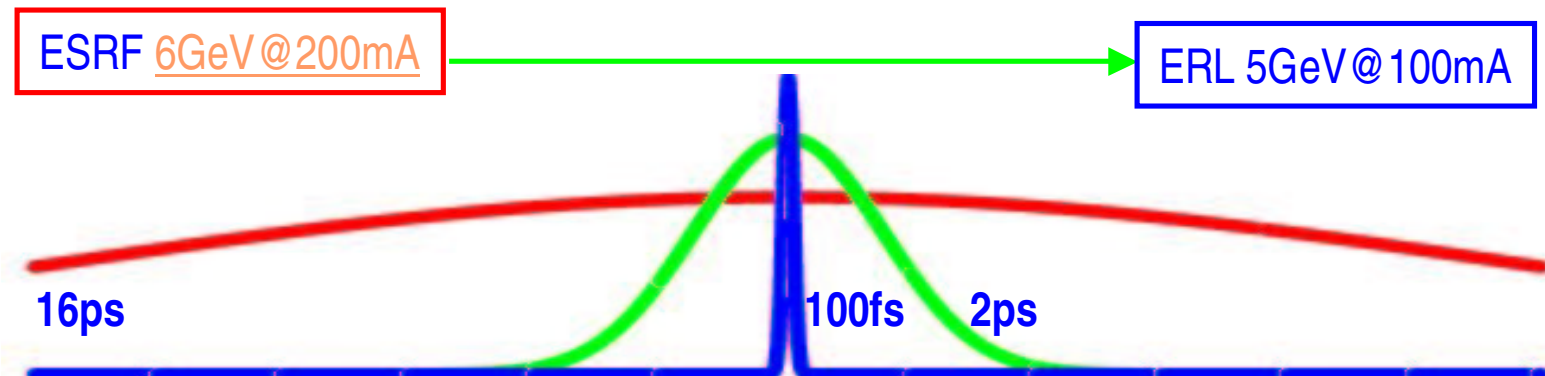

# Flux and Brilliance

03/23/2004

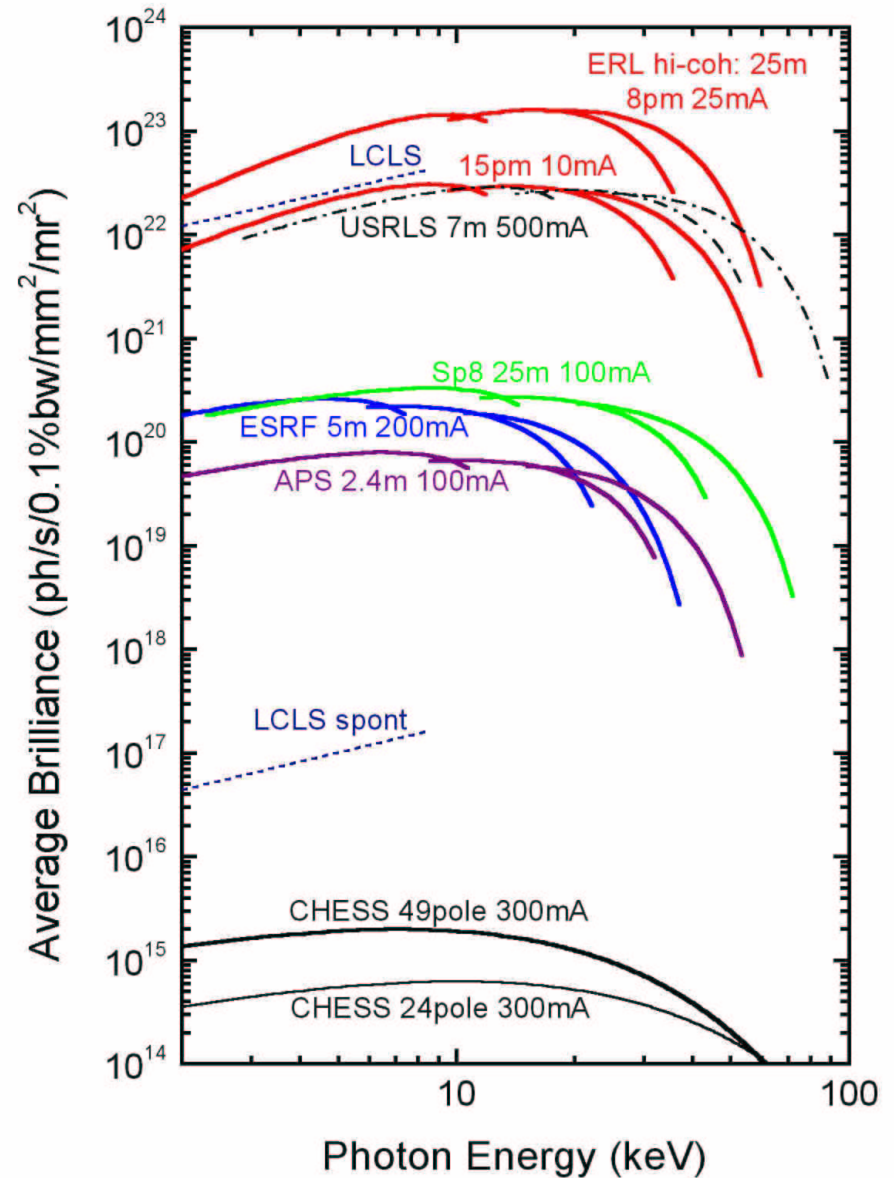
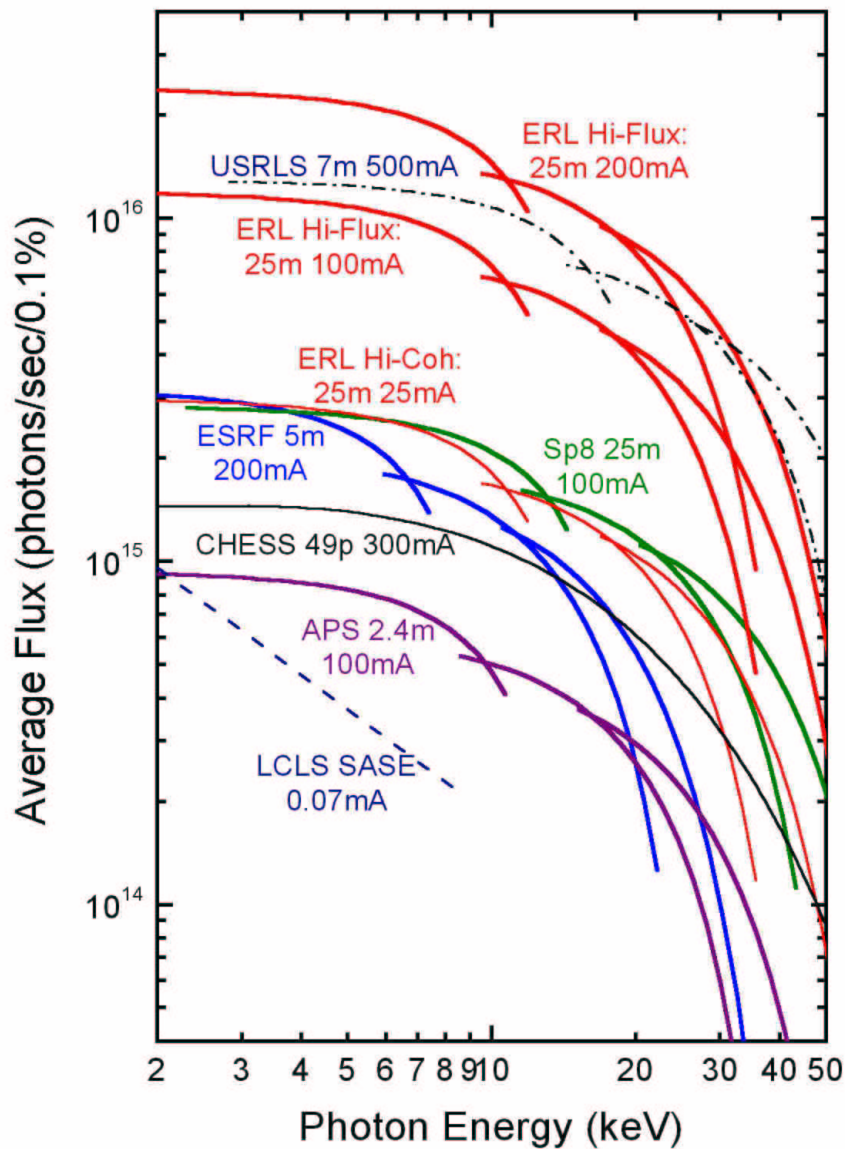



# Time resolution and coherence

03/23/2004

Short pulses, high brilliance:

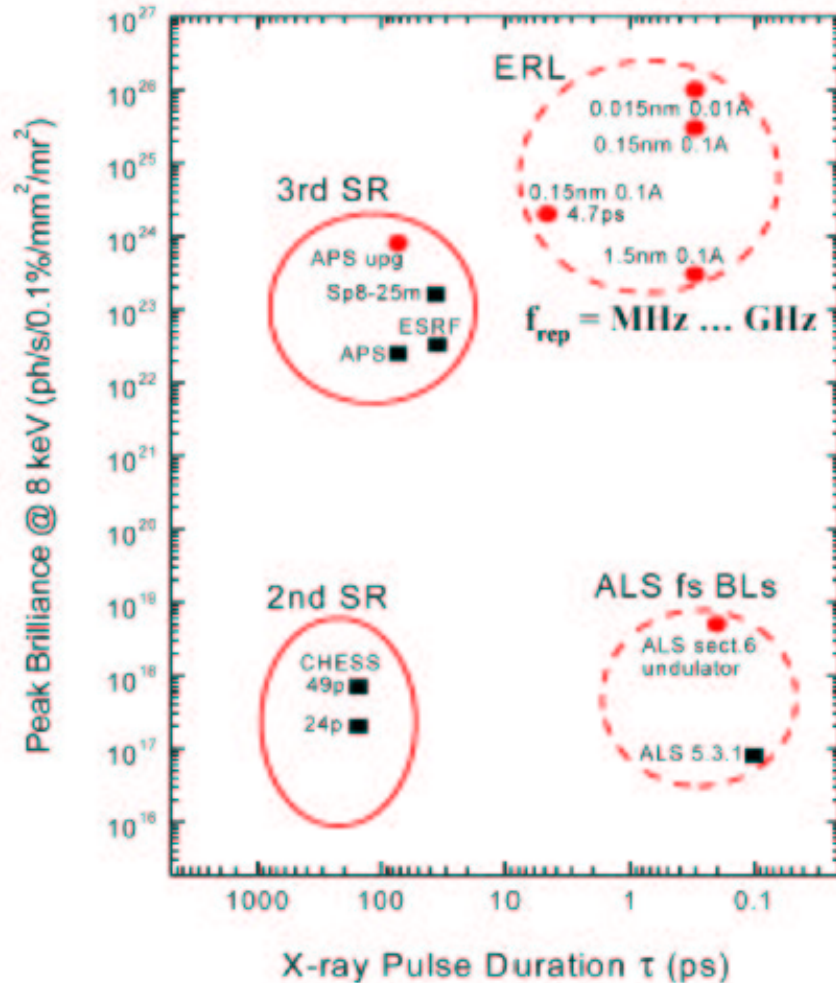

High coherent fraction:

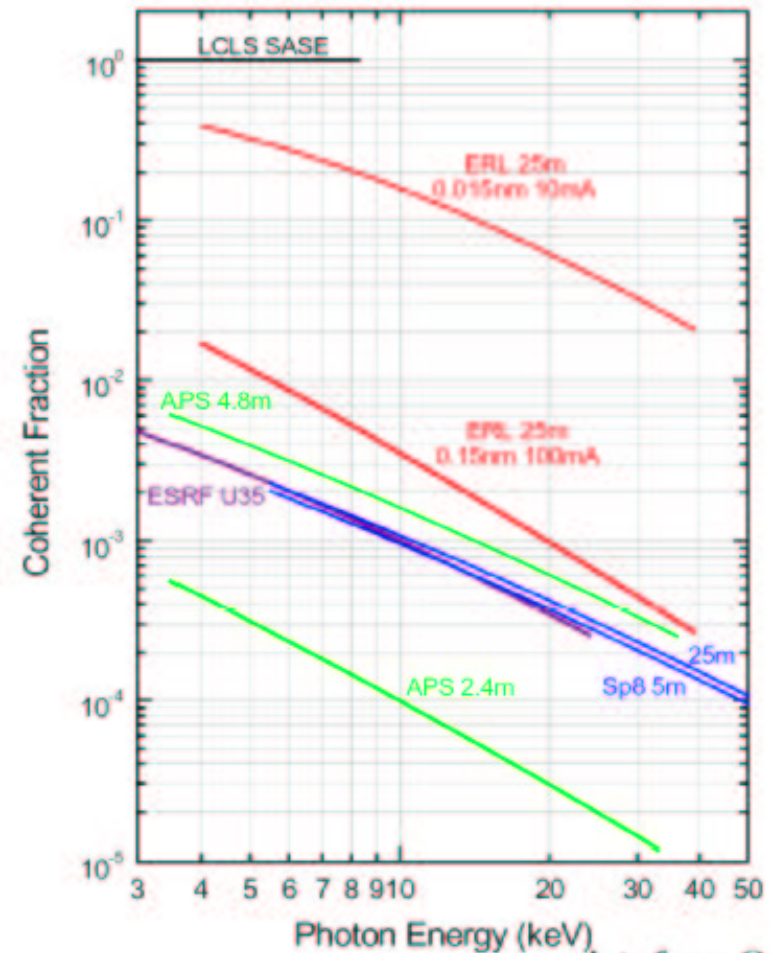

plots from Q. Shen

Georg.Hoffstaetter@Cornell.edu



# Energy Recovery & Linear Coll.

## A Possible Apparatus for Electron Clashing-Beam Experiments (\*).

M. TIGNER

*Laboratory of Nuclear Studies, Cornell University - Ithaca, N. Y.*

(ricevuto il 2 Febbraio 1965)

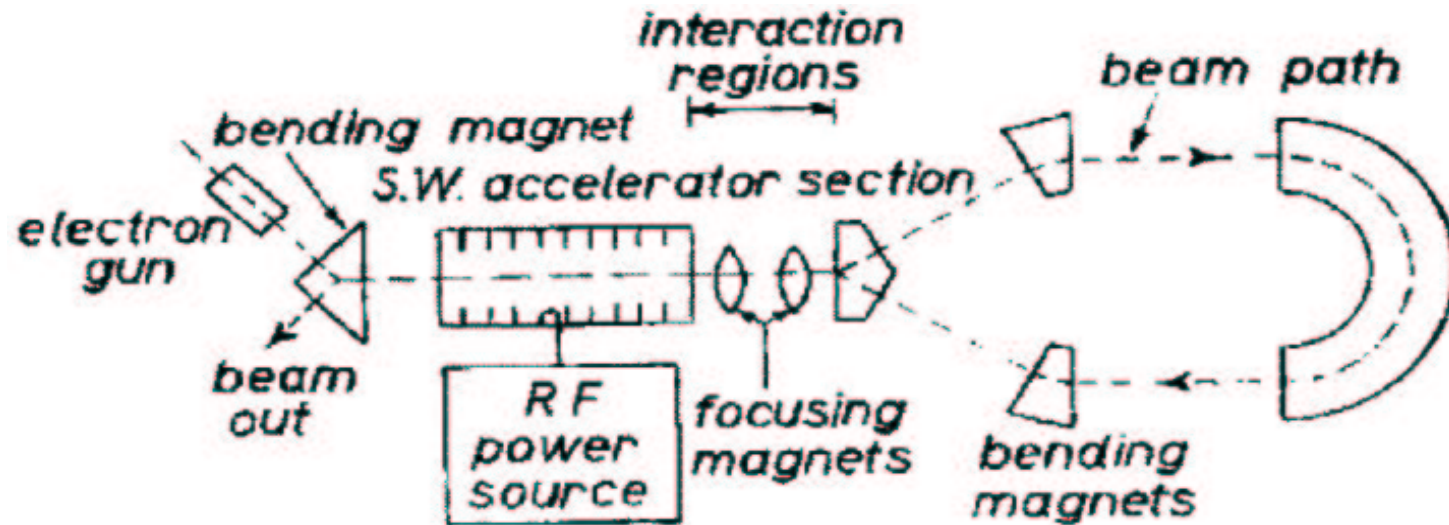

Energy recovery needs continuously fields in the RF structure

- Normal conducting high field cavities get too hot.
- Superconducting cavities used to have too low fields.

# Previous Energy Recovery Linacs

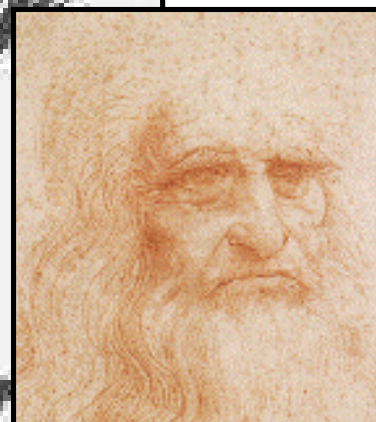
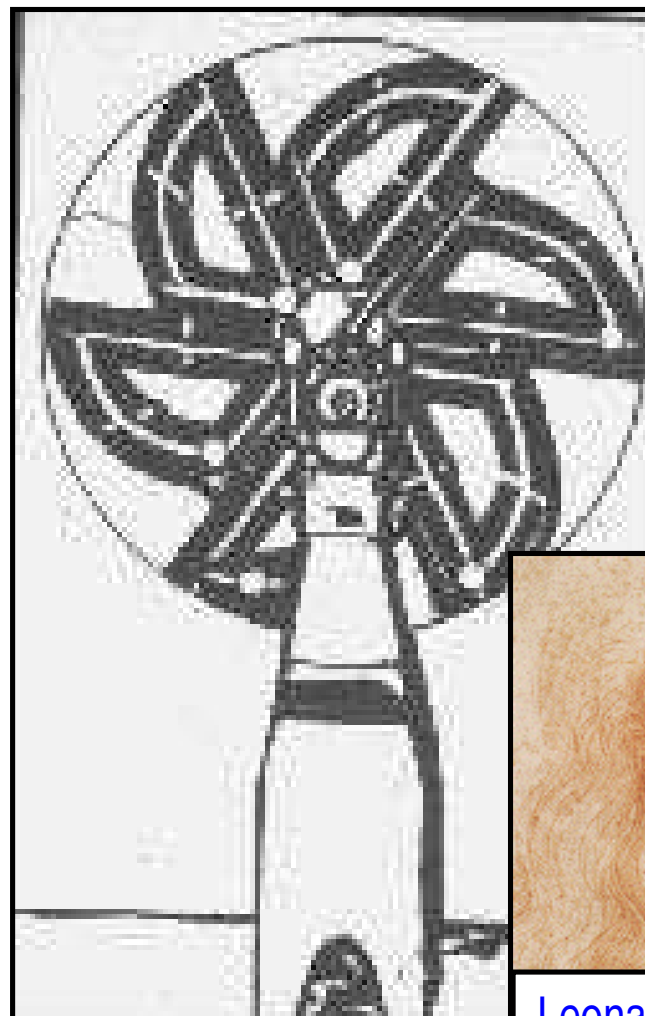

Leonardo da Vinci  
(1452-1519)

# ERLs in the World

After the success of high gradient super-conducting RF, several laboratories have worked on ERLs:

Upgrades of: TJNAF, JAERI

Light production: Brookhaven, Cornell, Daresbury, KEK, Novosibirsk

Electron Ion colliders: TJNAF

High energy electron cooling for RHIC: Brookhaven

Neither an electron source, nor an injector system, nor an ERL has ever been built for the required large beam powers and small transverse and longitudinal emittances.

⌘ A prototype at Cornell should verify the functionality

# Limits to ERLs

## Limits to Energy :

- Length of Linac and power for its cooling to 2K

## Limits to Current :

- Beam Break Up (BBU) instability

## For narrow beams :

- Coulomb expulsion of bunched particles (Space Charge)
- Radiation back reaction on a bunch (CSR)

# Instability with a single cavity and single Higher order mode

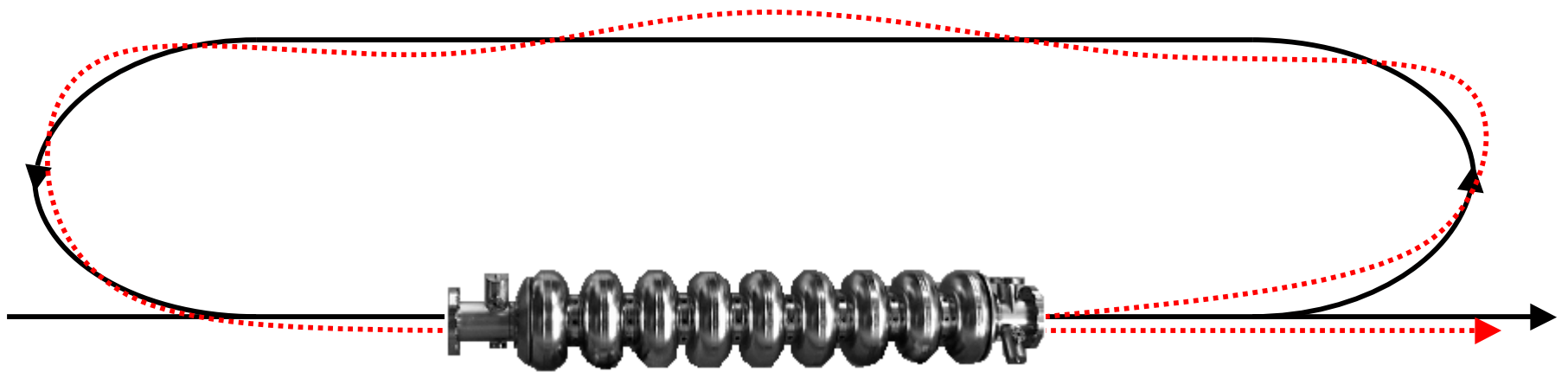

$$V_x(t) = \int_{-\infty}^t W_x(t-t') d(t') I(t') dt', \quad d_x(t) = T_{12} \frac{e}{c} V(t-t_r)$$

$$V_x(t) = T_{12} \frac{e}{c} \int_{-\infty}^t W_x(t-t') V(t'-t_r) I(t') dt'$$

# Comparison with Tracking

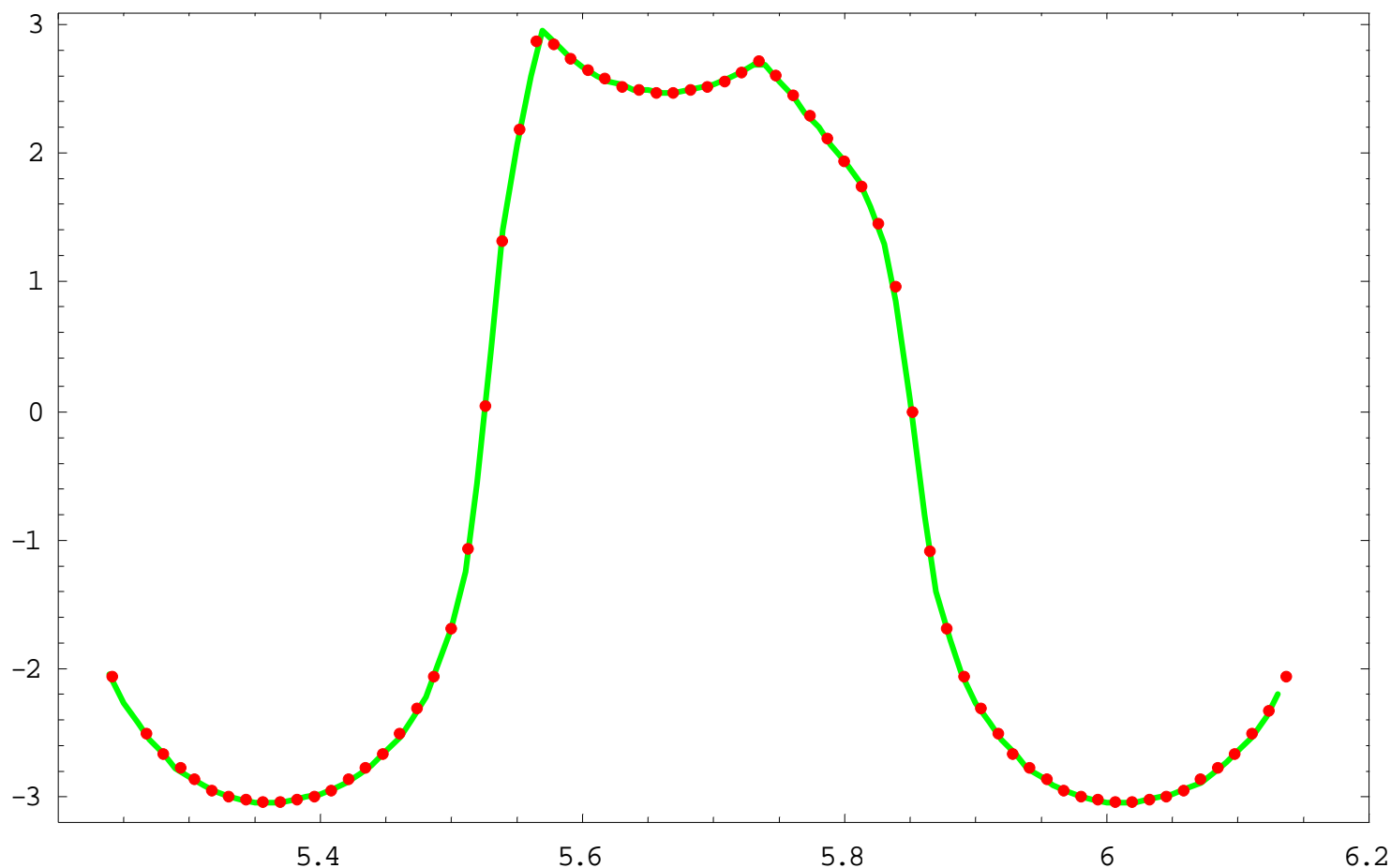

This agreement shows both, the quality of tracking and that of the theory.



# Results on BBU

Many HOMs in one cavity :

- only the most dangerous HOM contributes to the threshold.

HOMs in different cavities :

- HOMs in different cavities cannot cancel, but they can be decoupled by optical choices.

Multi turn recirculation :

- The threshold decreases approximately quadratically with the number of turns.

Closed orbit drift instability :

- Always has a threshold that is larger than the coherent oscillation BBU

# BBU limit for the 5GeV ERL

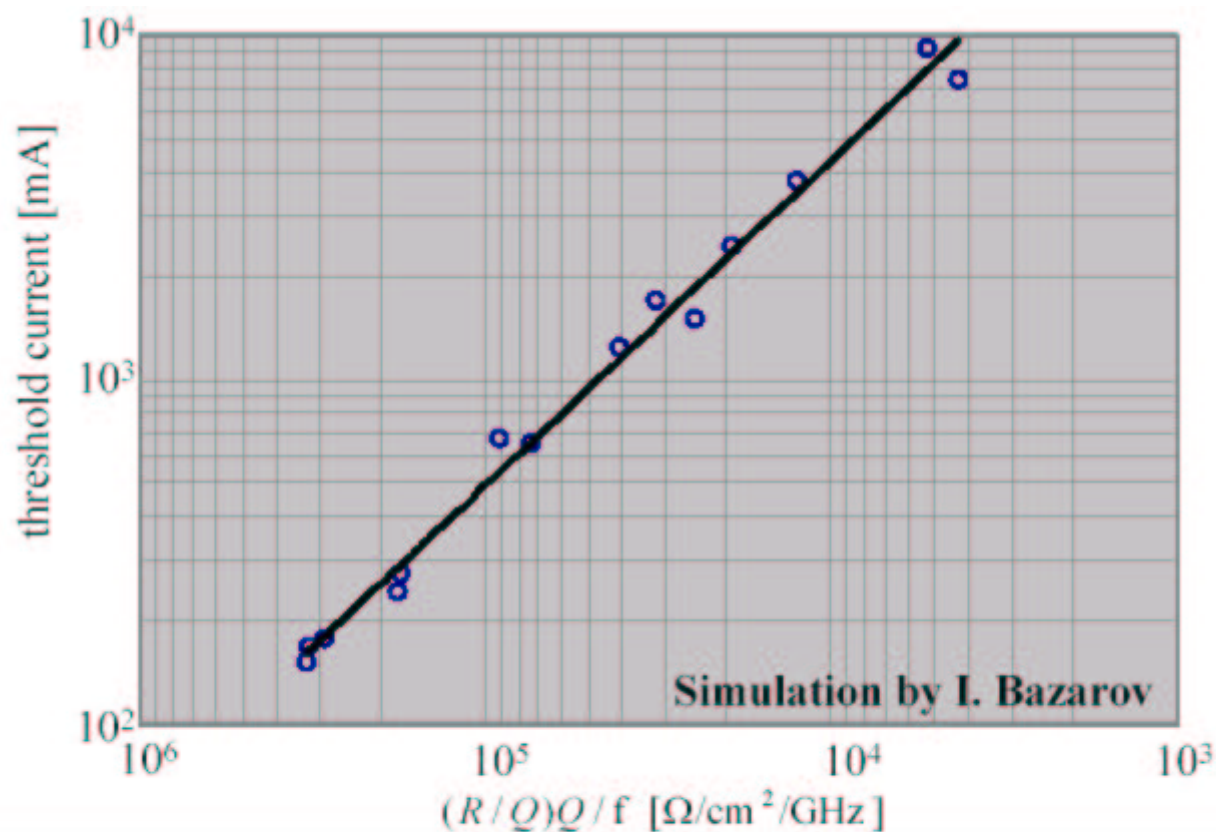

**$\Rightarrow (R/Q)Q/f < 2 \cdot 10^5 \Omega/\text{cm}^2/\text{GHz}$  required for BBU instability current  $> 100$  mA (with safety-factor).**

# Gun simulations

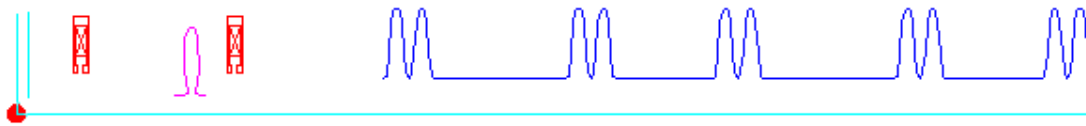

z

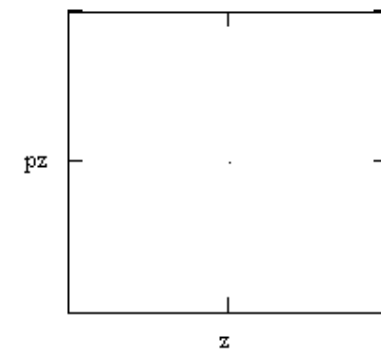
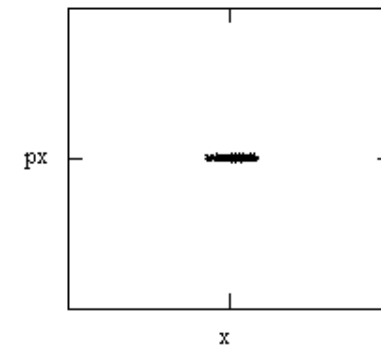
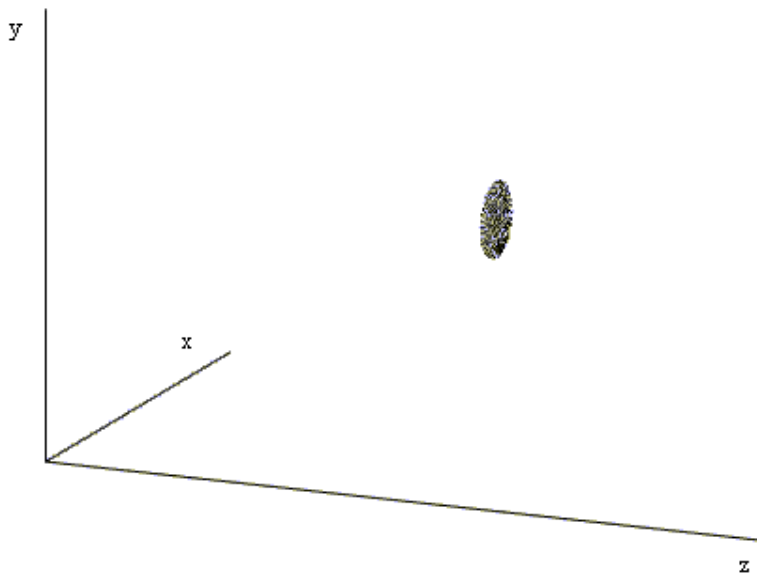

# Emit. scaling vs. charge, vs. bunch length

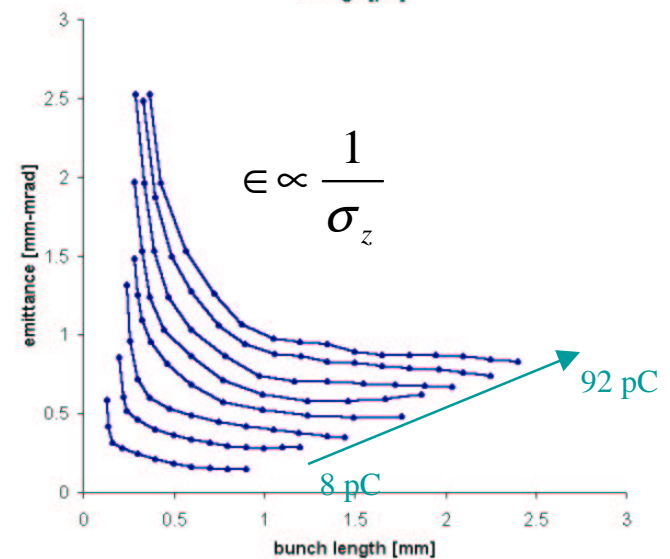
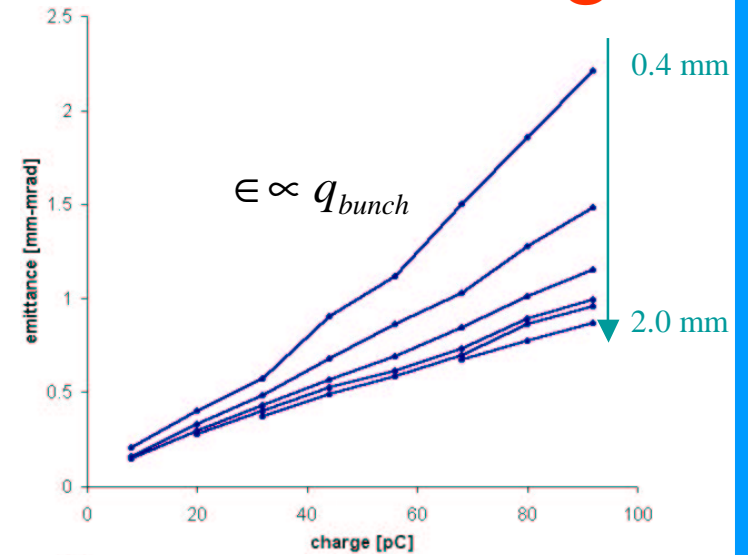
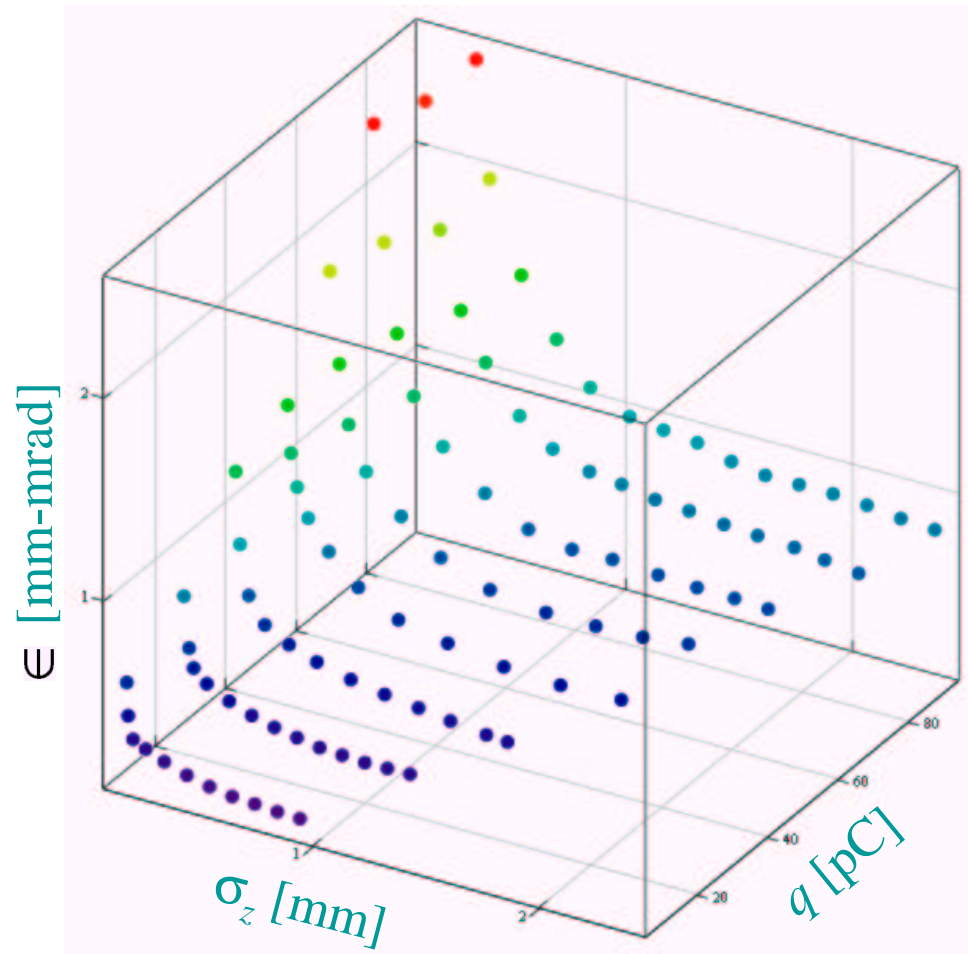

# Optimization results

- Optimization for emittances in case of transverse uniform, longitudinal gaussian 'laser' profile:
  - 0.086 mm-mrad for 8 pC/bunch
  - 0.58 mm-mrad for 80 pC/bunch final bunch length < 0.9 mm
  - Ongoing simulations for an ideal gun lead to even much smaller emittances
  - 5.3 mm-mrad for 0.8 nC/bunch
- Simulations suggest that thermal emittance is not important for high charge / bunch ( $\sim$  nC), but is important for low charge bunch ( $\sim$  pC)
- Better results if longitudinal laser profile shaping can be employed
- Note: results are similar to those of RF guns

# Emittance Growth in the Merger

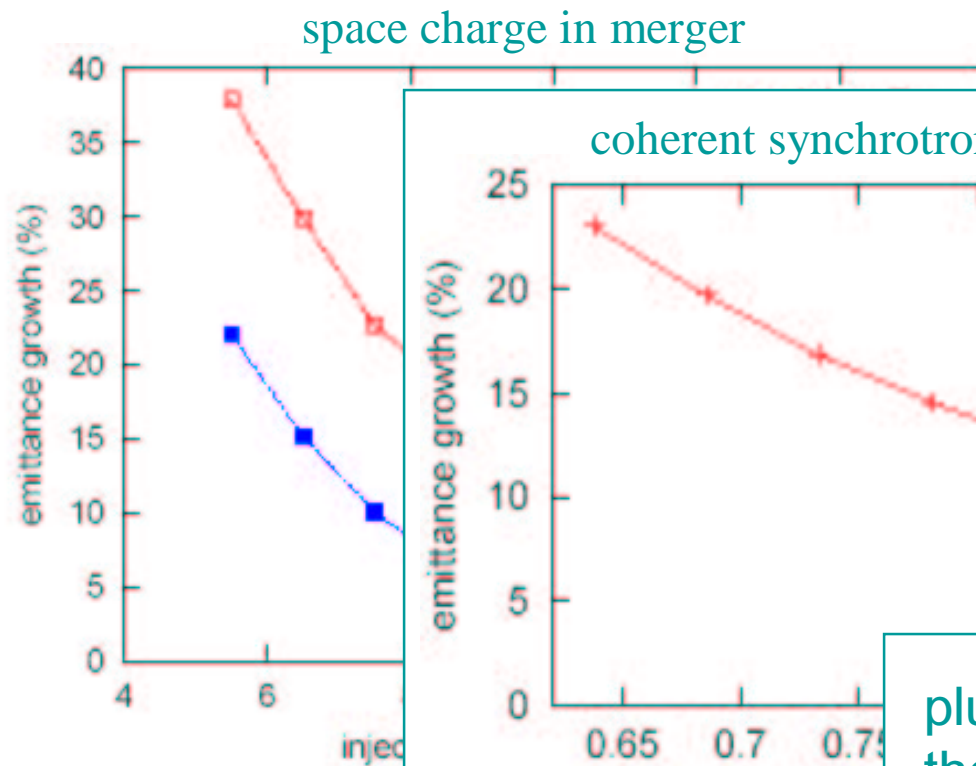

Figure 4: Emittance growth due to space charge for different injected emittances. Normalized emittance is taken to be 1.0.

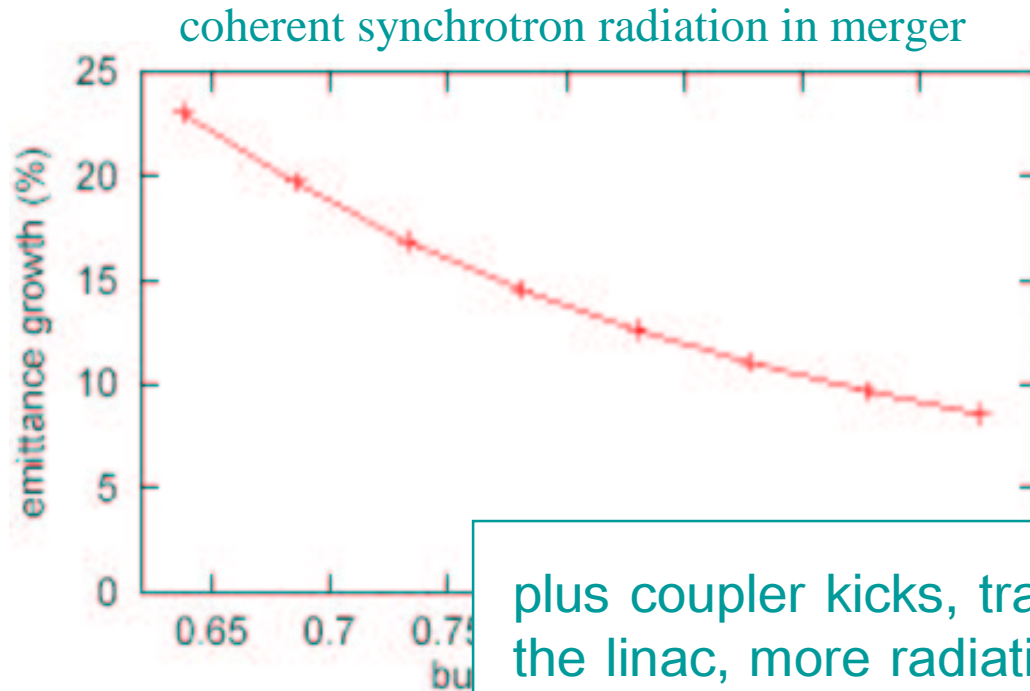

Figure 5: Emittance growth due to coherent synchrotron radiation for a 77-pC bunch as a function of dipole bend angle for 0.65 normalized emittance is taken to be 1.0.

plus coupler kicks, transport in the linac, more radiation in the arcs (both coherent and incoherent), wakes, optical aberrations (chromatic and geometric)...



# ERL Prototype Ia+Ib

Dump with quadrupole optic

Main linac

Injector

Gun  
Buncher

Bates bends

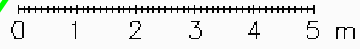

30m

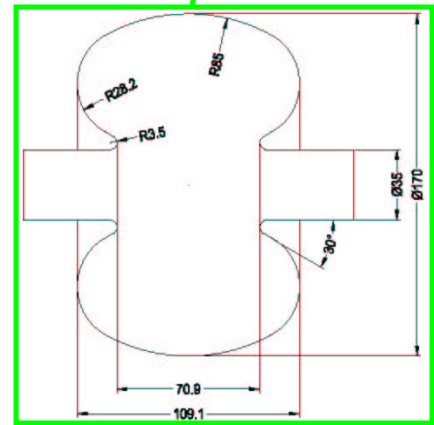
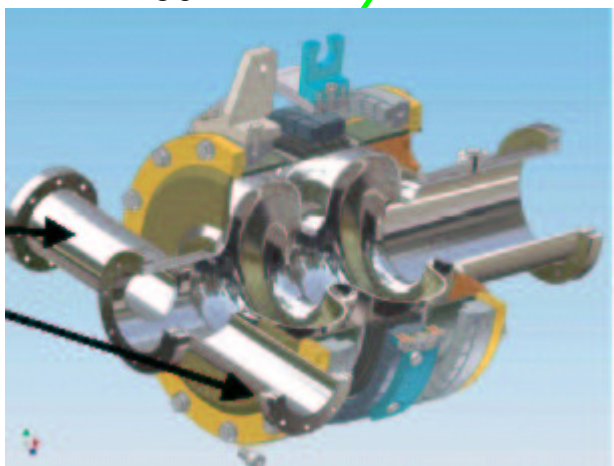

# Injector coupler

- 1 Coupling: 50 kW, but only 4% emittance growth due to coupler-focusing
- 1 Flexibility: Energy gain = 1 to 3 MV,  $Q_{ext} = 4.6 \cdot 10^4$  to  $4.1 \cdot 10^5$
- 1 Close to the TTF III coupler but:
  - 62mm (from 40) coax line
  - multicasting free
  - larger antenna
  - travel range increased (15mm)
  - air-cooled bellows (from 400K)

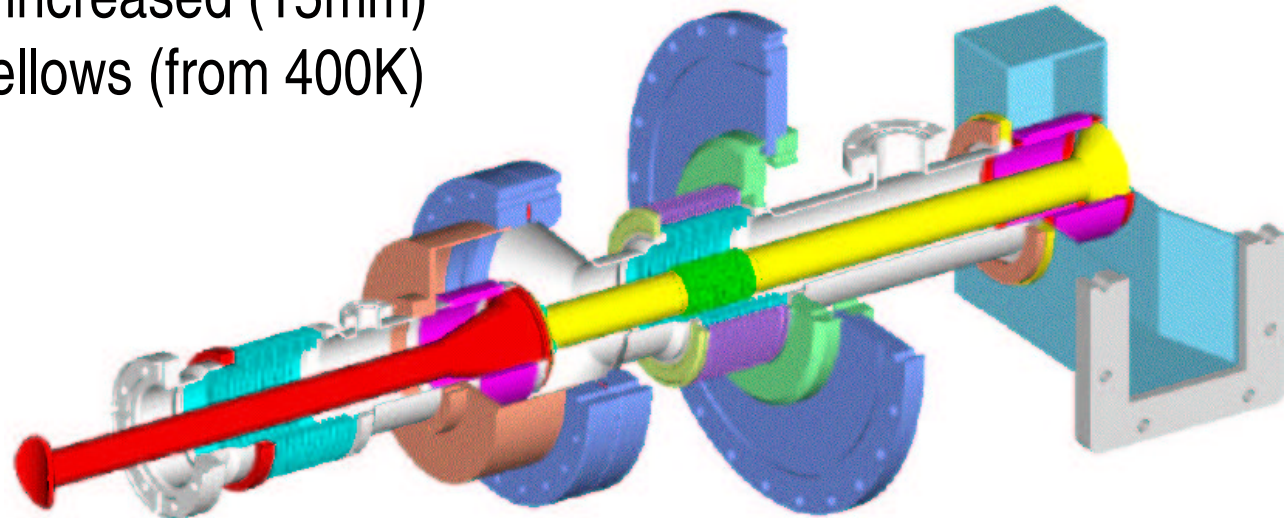

# Injector cryomodule concept

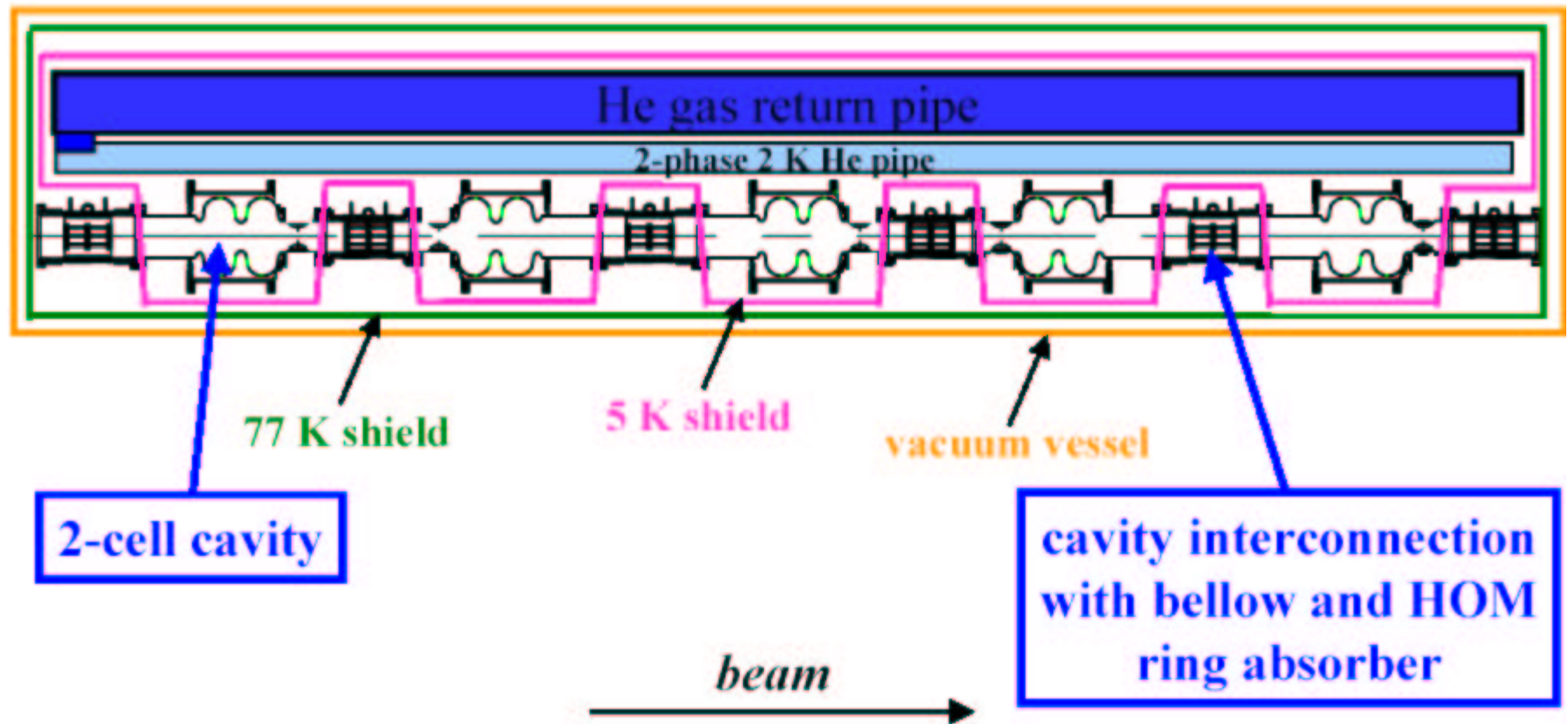

# Ferrite shielded bellows

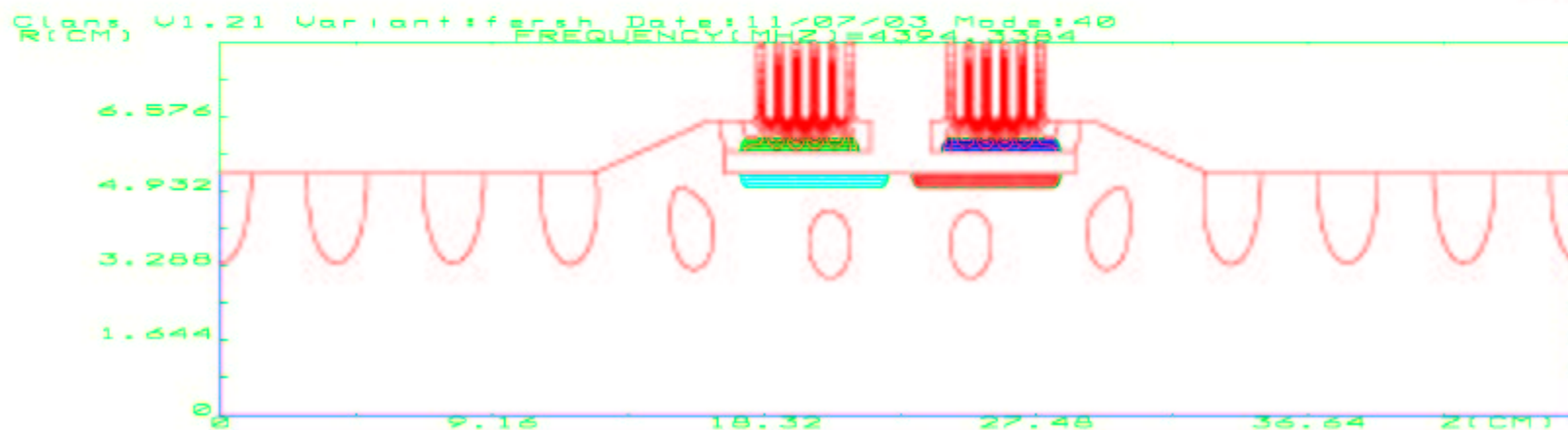
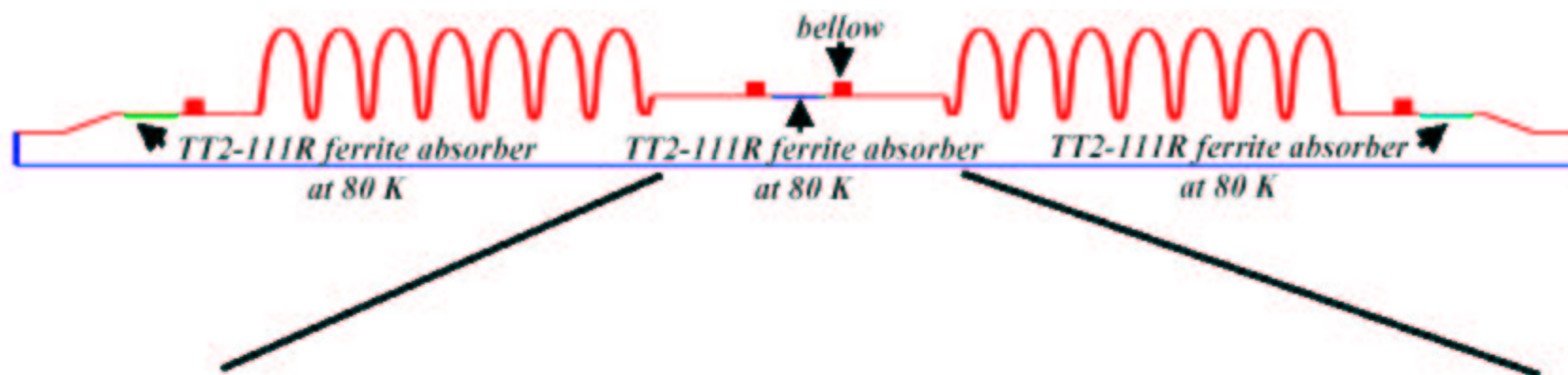

The bare bellows would lead to a loss factor of 1.2V/pC into the bellows.  
The ferrite shielded bellows absorb the HOM power in the cooled ferrite.

	ERL buncher cavity	ERL s.c. injector cavities	ERL s..c. main linac cavities
frequency [MHz]	1300	1300	1300
number of cavities	1	5	7
cells per cavity	1	2	7
R/Q [ $\Omega$ ] (circuit def.)	105	109	392
$Q_0$	20,000	$> 5 \cdot 10^9$	$> 10^{10}$
$Q_{\text{ext}}$	9,900	$4.6 \cdot 10^4$ ( $4.1 \cdot 10^5$ )	$2.6 \cdot 10^7$ for 25 Hz peak detuning
acc. voltage per cavity [MV]	0.12	1 (3)	$\approx 16$ (20 MV/m)
required klystron power per cavity [kW]	7	130	11
required relative amplitude stability (rms)	$8 \cdot 10^{-3}$	$1 \cdot 10^{-3}$	$3 \cdot 10^{-4}$
required phase stability (rms)	$0.1^\circ$	$0.1^\circ$	$0.06^\circ$



# ERL@CESR being analyzed

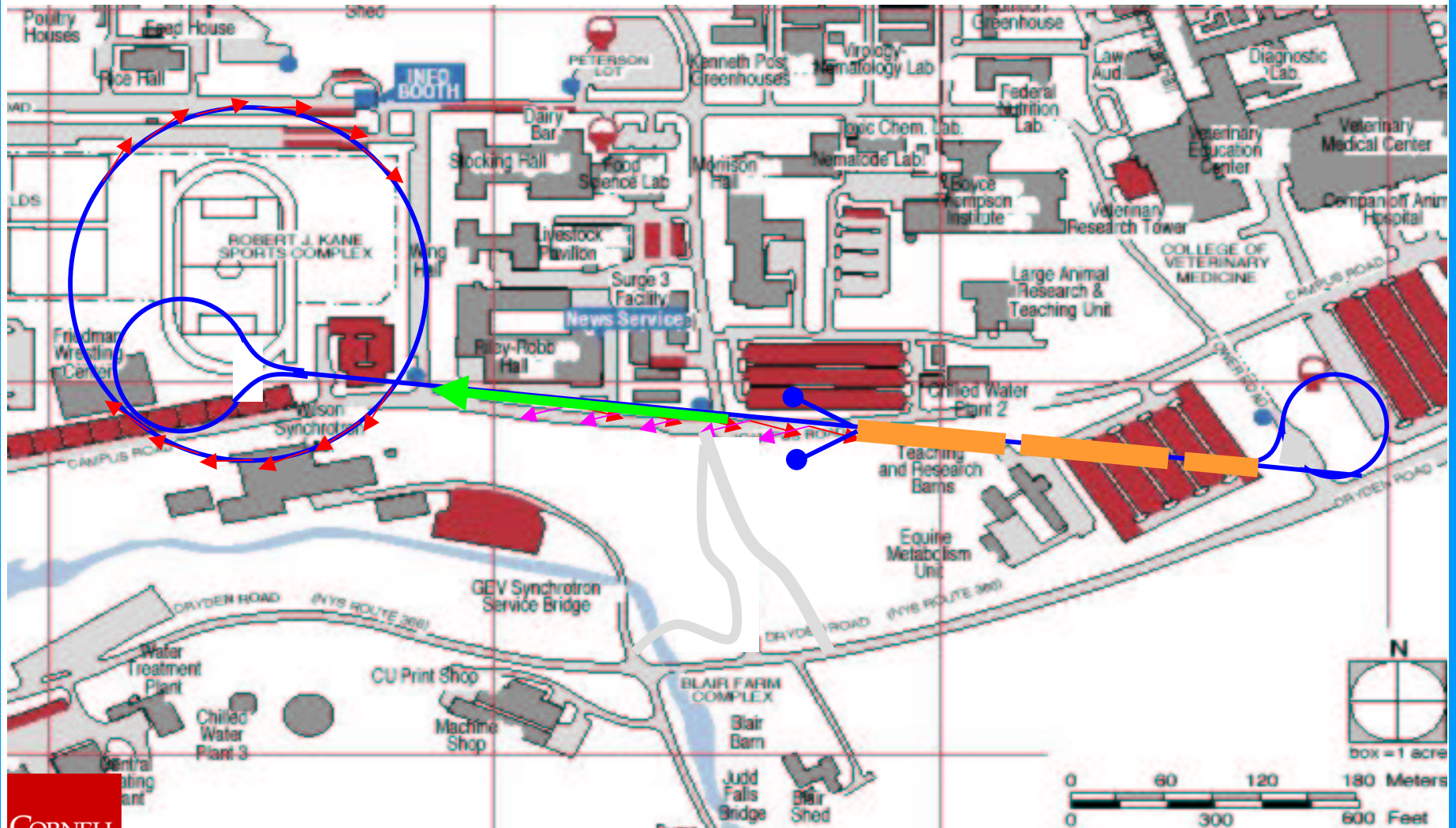



# Advantages of ERL@CESR

- 1 Use the tunnel for ERL-Phase-Ib.
- 1 Operation of CESR and ERL test simultaneously.
- 1 Use all of the CESR tunnel, which would be more of an upgrade.
- 1 Much more space for undulators.
- 1 Space for future upgrades, like an FEL.
- 1 Future extensions are possible.
- 1 No basements of existing buildings to worry about.
- 1 Only one tunnel for two linacs.
- 1 Less cryo lines needed since there is only one linac tunnel.

# Double linac tunnel

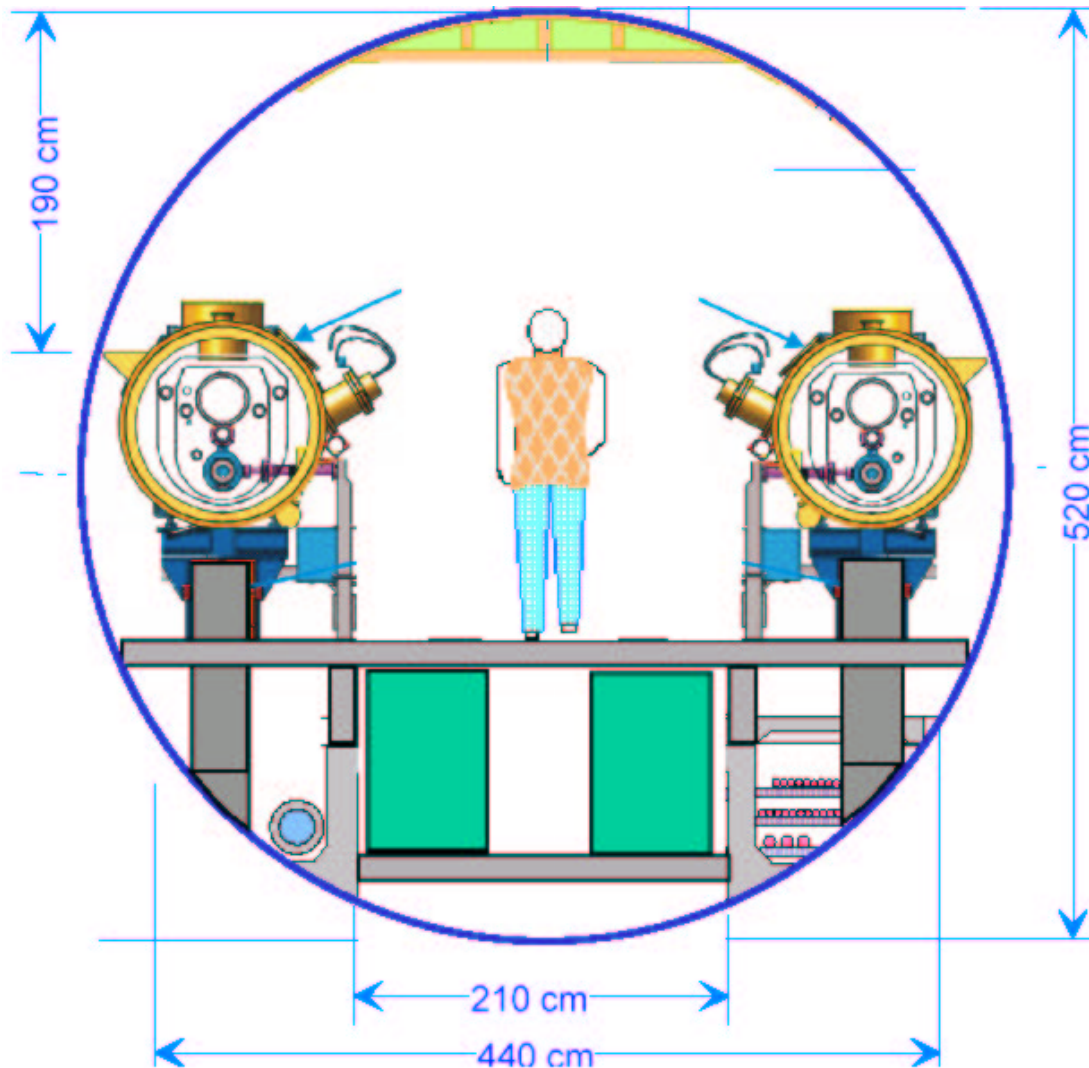

# Parameters

Parameter		Prototype	Light source
Energy	(GeV)	<u>0.1</u>	<u>5</u>
Current	(mA)	100	100
Inj. energy	(MeV)	5–15	5–15
Rep. Rate	(GHz)	1.3	1.3
Acc. gradient	(MV/m)	20	20
Q of cavities	( $10^{10}$ )	1	1
external Q	( $10^7$ )	2.6	2.6
Charge/Bunch	(pC)	77	77
nominal $\sigma_E$	( $10^{-3}$ )	0.2	0.2
nominal $\sigma_\tau$	(ps)	2	2
nominal $\epsilon_N$	( $\mu\text{m}$ )	2	2
short pulse $\sigma_\tau$	(ps)	< 0.1	< 0.1
microbeam $\epsilon_N$	( $\mu\text{m}$ )	0.2	0.2
Main Linac Cavities		<u>5</u>	<u><math>\approx 250</math></u>
Cooling@2K	(kW)	<u>0.2</u>	<u><math>\approx 17</math></u>

# HOM Damping in the ERL Main Linac

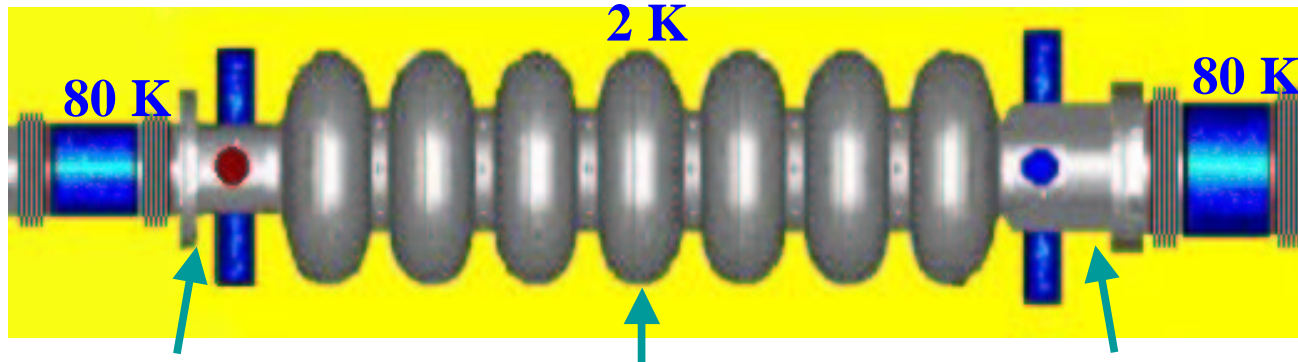

small 78 mm beam tube      7-cell s.c. cavity, TESLA shaped center cells      large 106 mm beam tube

- In average 140 W losses per cavity from beam-excited monopole modes.
- Opposite HOM couplers to reduce transverse kicks.
- Enlarged beam tube on one side to propagate all TM monopole modes and most dipole modes.
- 6 HOM loop coupler per cavity to reduce power per coupler and to damp quadrupole modes reliable.
- Ferrite broadband absorbers at 80 K between cavities to damp propagating modes.

# Ferrite shielded bellows

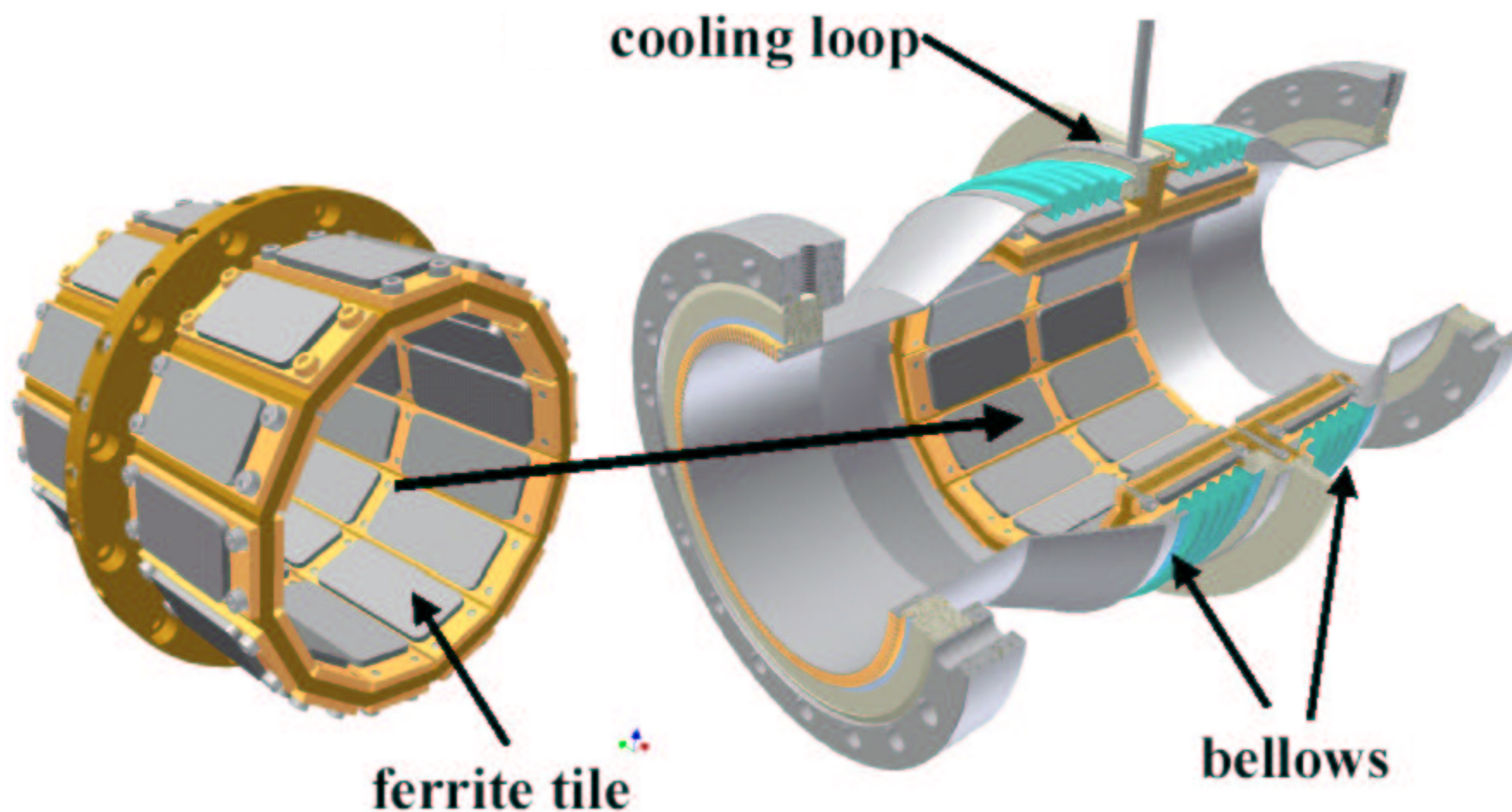

# Linac optics

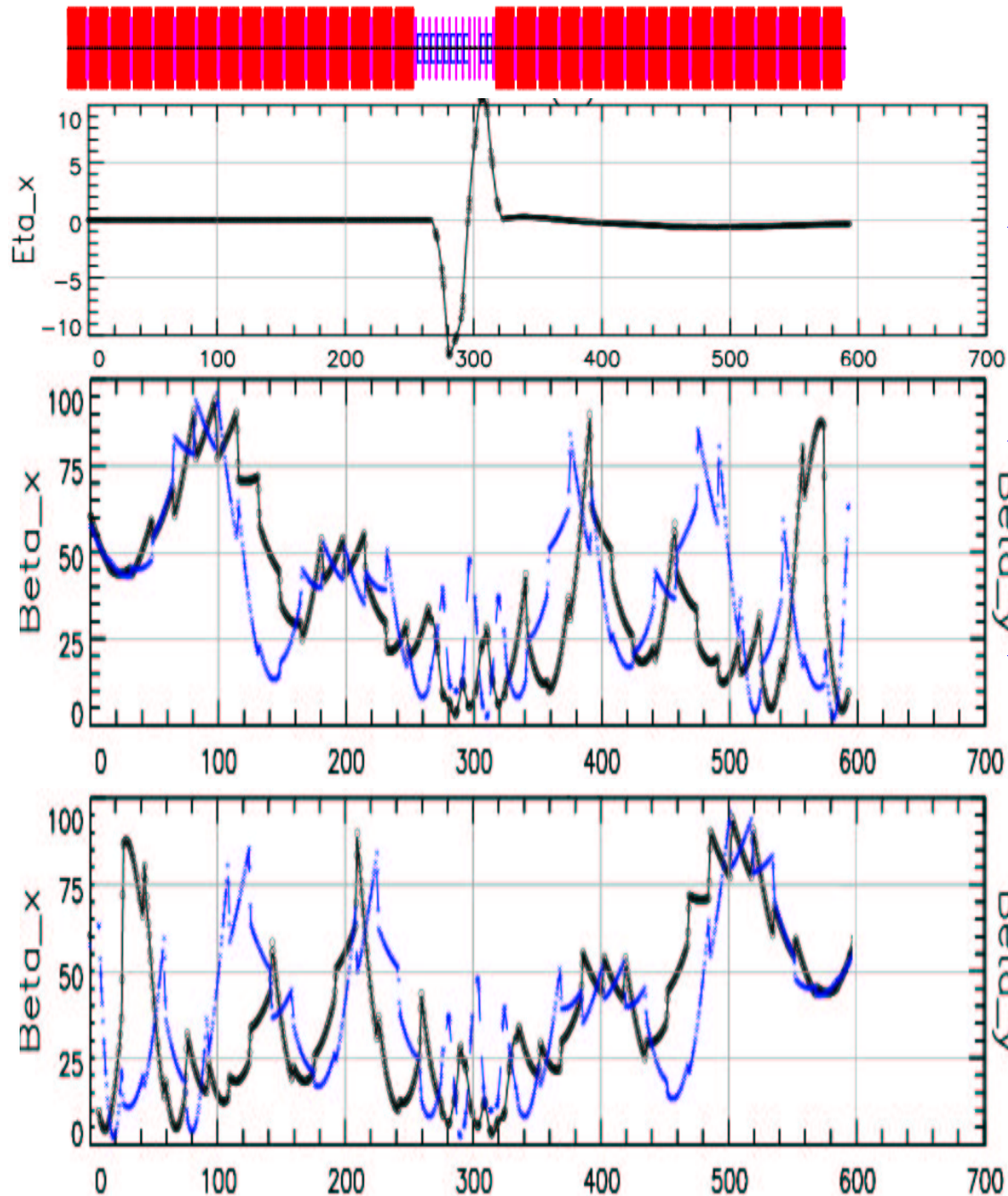

Optimize optics in the Linac  
for the accelerated and the  
decelerated energy.



# Optimization of Tunnel Layout

**Requirements:** Fit in  
two 2 m undulator, ———→  
four 5 m undulators, and ———→  
one 25 m undulator and ———→  
achromats between the undulators

Achromats

## Dispersion for short bunch operation

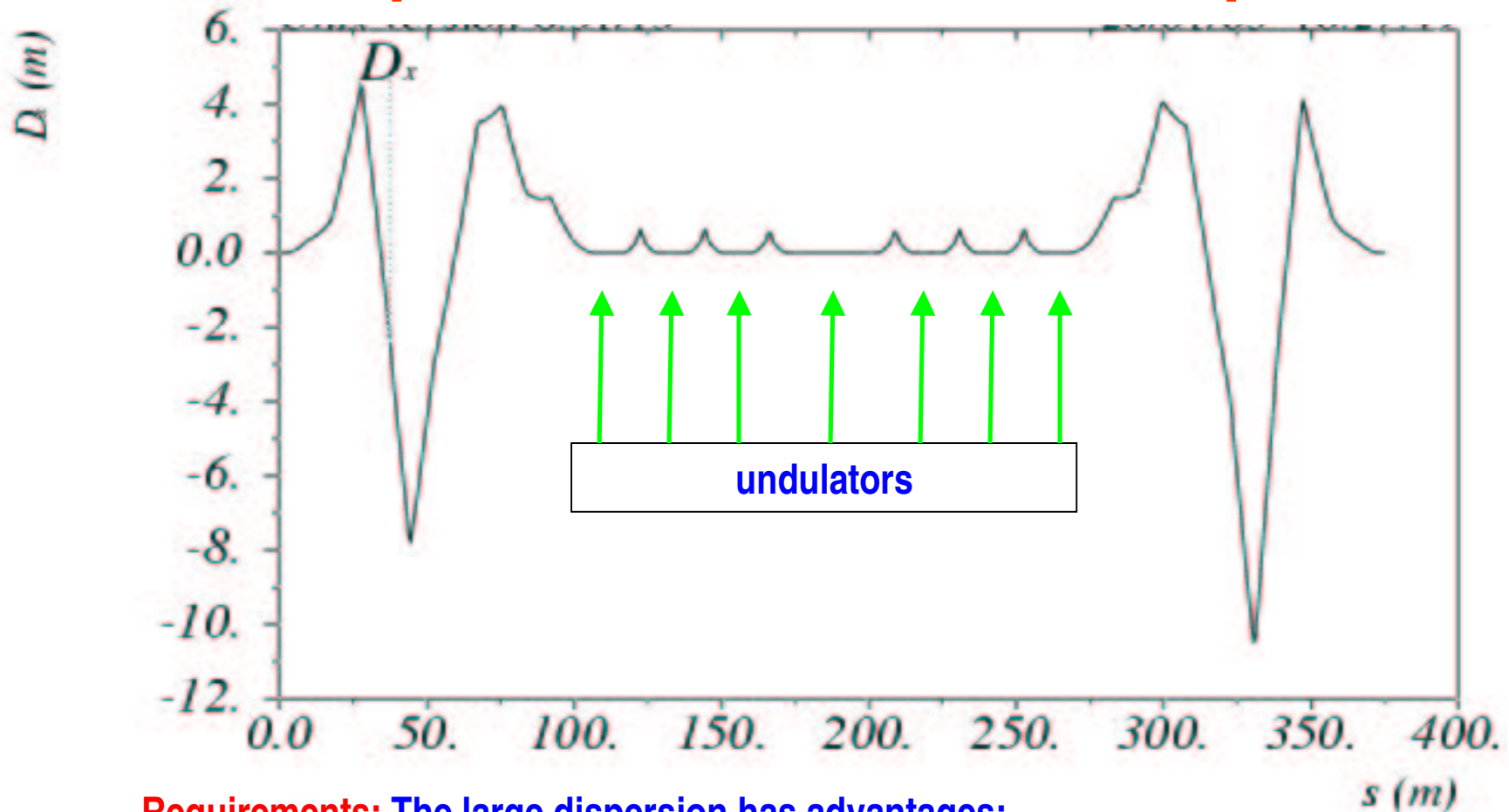

**Requirements:** The large dispersion has advantages:

Can be used to manipulate R56, and with sextupoles also higher chromatic orders.

# Emittance with CSR and nonlinear optics

03/23/2004

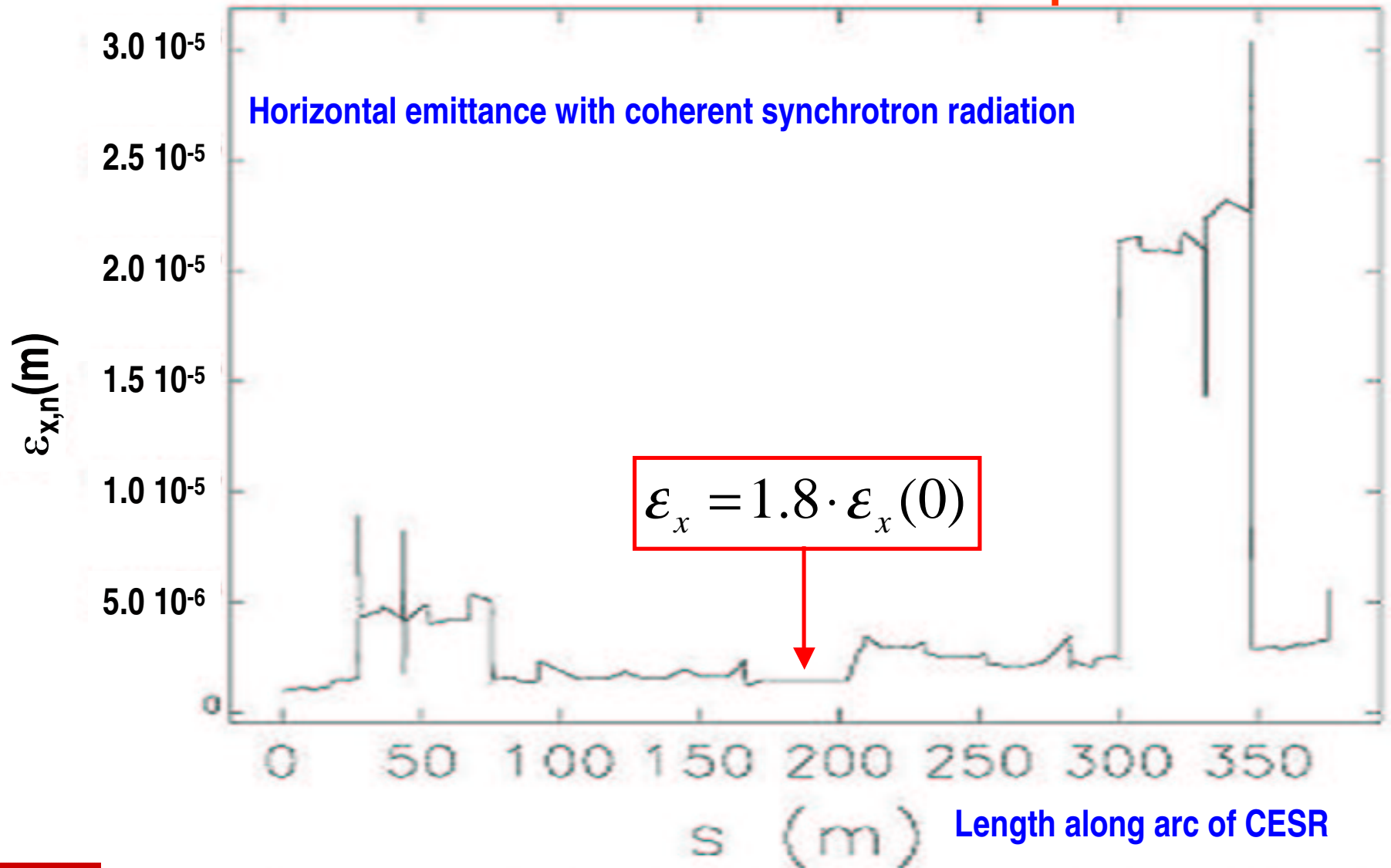

CORNELL

**Result:** After suitable nonlinear bunch length manipulation, the emittance growth can be controlled in all undulators.

# Conclusion

- 1 Possibilities of extending the CESR tunnel to accommodate an ERL have been investigated.
- 1 First and second order optics have been found for an ERL
  - which uses the current CESR tunnel and many of its components
  - which can be used to compress 2ps bunches to 100fs
  - which leads to less than a factor of 2 in transverse emittance increase due to CSR
  - Nearly all quadrupoles and sextupoles have a strength which can be achieved in CESR today
  - The BBU limit is at least as large 100 – 200mA

- 1 This upgrade of CESR to an ERL light source would be a demonstration of an upgrade path that could then be open to many existing X-ray rings.