

THE

STANDARD MODEL

Fundamental Particles

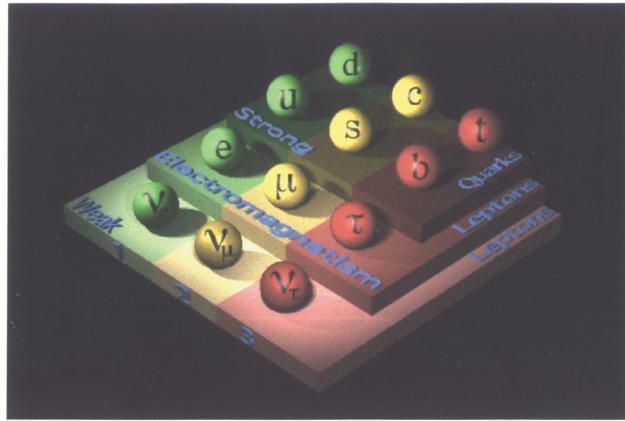
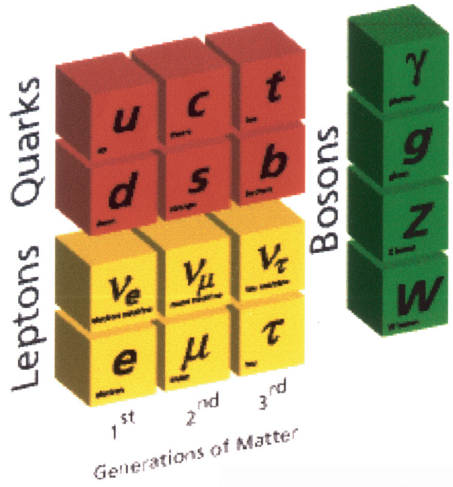

CORNELL
UNIVERSITY

LEPP

LABORATORY FOR ELEMENTARY-PARTICLE PHYSICS

Prepared by:

Ahren Sadoff, Professor of Physics
and

Lora Hine, Educational Outreach Coordinator

e-mail: outreach@lns.cornell.edu

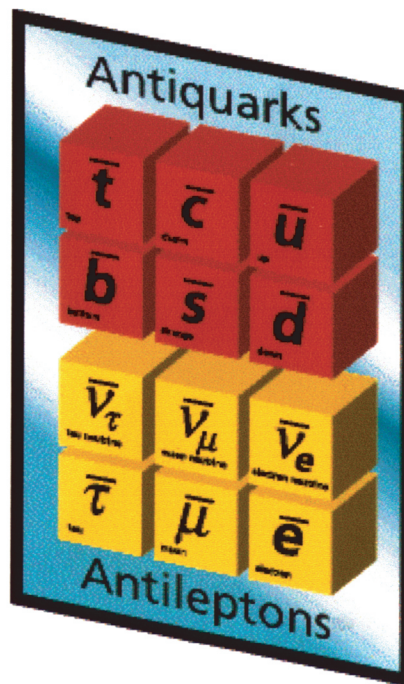
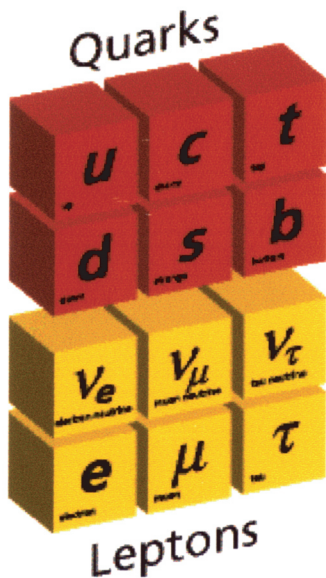

The Standard Model

1 Introduction

When we look at this world we live in, it appears to be a very, very complex place made up of millions of structures from inanimate objects like oceans, mountains, planets and stars to a vast variety of plants and animals, including us. Is our universe composed of an almost infinite number of different objects, or is there a basic, simple set of fundamental building blocks of matter from which everything else is made?

This is a question that goes back some 2500 years when Aristotle proposed that Air, Earth, Fire and Water were the basic building blocks and other Greek philosophers proposed the idea that atoms were the fundamental building blocks of matter. What we call "The Standard Model" is our most modern attempt to answer this age-old question. It appears to be extremely successful in that, up to now, all predictions of the theory have been experimentally verified.

The Standard Model goes beyond the question of matter and also attempts to answer the same question about forces. Again, when we observe our world, there seems to be a wide variety of forces: gravitational, electrical, magnetic, muscular, frictional, atomic, and nuclear to name a few. Can we understand the large number of different forces in terms of a relatively small number of fundamental forces? The Standard Model says yes!! In fact, it goes further in that it also correlates the fundamental forces with the fundamental particles of matter in that each particle "feels" only certain forces and not others.

At this point a clarification should be made between "elementary particles" and "fundamental particles", names which are sometimes used interchangeably and could be confused. Fundamental particles are basic building blocks which cannot be broken down into smaller entities, while another name for elementary particles could be sub-atomic. They are not necessarily fundamental, but some could be. For instance, protons and neutrons are elementary particles but are not fundamental since they are composed of smaller, fundamental particles. For a more detailed description of the different types of particles see the Particle Physics Flowchart on the last page of this article. The various and probably unfamiliar names will be explained in the text that follows.

Ironically, an understanding of the sub-atomic particles, the smallest objects, is necessary to understand the largest structure we know of, the universe itself. This is because during the first fraction of a second just after the Big Bang (the name for the beginning of the universe), the temperatures were so immense that the only things that could exist were the elementary particles. Any nuclei or atoms that could form would be instantly ripped apart due to the unimaginable heat at the time. So, an understanding of the smallest objects is necessary to understand the evolution of the universe itself.

2 The Basic Ideas of the Standard Model

A key word in understanding the Standard Model is *unification*. Another key word is *simplicity*. Unifying ideas should allow us to understand seemingly complex systems in terms of a few, simple fundamental objects.

As indicated above, the Standard Model unifies both matter and forces into a small

number of basic entities. This is just what the Greeks attempted to do with their Atomic Model. In their picture, the atom was a small, indestructible solid ball. All matter was composed of a relatively small number of different atoms. But during the latter part of the nineteenth century, experimental evidence indicated that the atom had to have an internal structure, so could not be fundamental. Further evidence suggested that the atom resembled a microscopic planetary system with negatively charged electrons circling a positively charged nucleus made up of protons and neutrons. So it was tempting to think that electrons, protons and neutrons would be fundamental particles. Three basic particles sounded very nice; it was a simple system. But, surprisingly, as physicists started exploring the nucleus with newly invented particle accelerators, they discovered more and more "elementary" particles. By about 1950, there was a "zoo" of over 100 known particles. A new unifying idea was needed and it came in the form of suggesting a new set of fundamental particles called *quarks*. But, before we can understand these new particles, we will need to first consider forces.

3 The Unification of Forces

What is a force? A simple definition is that it is something that creates a push or pull. But as we shall see, a more meaningful definition is that a force is an interaction between two or more objects. For instance, the electric force is due to the interaction between electrical charges, while the gravitational force is due to the interaction between masses.

3.1 Everyday Forces

How do we unify the seemingly large number of disparate forces into just a few forces? As an example, let's consider the following list: general contact forces, frictional, muscular, pressure forces, and chemical. At first glance, they appear very different, but they are all due to the interaction between atoms.

So, how do atoms interact with each other? The answer is that there is no special "atomic" force. Rather, atoms interact by the familiar attraction or repulsion due to electrical charges. In fact, the atom itself is held together by the attraction of the negatively charged electrons to the positively charged nucleus. So, every force that we normally experience, except for gravity, is due to the electrical force. In addition, it was shown in the nineteenth century that the electric and magnetic forces are not separate forces, but are manifestations of one force called the Electromagnetic force. We can produce an electrical force from a magnetic force and vice versa. Thus, our everyday life is completely controlled by just two forces, Gravity and the Electromagnetic force.

3.2 Nuclear Forces and a Unification

Besides these, we know of just two other forces. They both have an effect only over nuclear dimensions and are known as the Weak and Strong nuclear forces. In fact, today, we have gone even further with unification in that we now understand that the Electromagnetic force and the Weak nuclear force are different manifestations of the same force, which is called the Electro-Weak force. This Electro-Weak unification is an intrinsic part of the Standard Model.

While the Standard Model has been a great success in that all experiments performed so far have verified its predictions, we know it is not complete. It does not unify the Strong nuclear force or Gravity with the Electro-Weak force. Our ultimate goal is to understand how to combine all these interactions in a single unified theory--- sometimes called "The Theory of Everything" or "TOE". We believe that this single primordial force only existed for a very, very short time ($\sim 10^{-35}$ sec.) right after the Big Bang. As the universe began to cool, this single force began to take on the different forms we see today. We can think of this as somewhat analogous to water taking on different forms as steam changes to liquid and then to solid ice as the temperature decreases. All are water, but in different forms.

3.3 How Forces are Transmitted; from Fields to Particles

There is another part of the force story that has to do with how forces are transmitted between different objects. In the nineteenth century, the idea of the "field" was introduced to answer the question as to how objects could interact over a distance (in the case of Gravity, over very large distances such as the 93 million miles between the earth and the sun). Every force has its field associated with it. For example, an electric charge produces an electric field throughout space and then this electric field can interact with a second electric charge that is located at some distance from the first. It is the interaction of the field produced by one electric charge on a second charge that produces the Electric force. It is exactly the same with Gravity except a mass produces a gravitational field which then interacts with another mass to produce the Gravitational force.

The field concept has proven to be very powerful and is used today for most purposes such as radio, television or microwave transmission. But in our most modern theory, each force field is associated with its own force particle. In this picture, a particular force is created between two matter particles when the appropriate force particle is exchanged between them. Figure 1 may help in visualizing how this comes about. It shows two ice skaters approaching each other from opposite directions. As they pass, one skater throws a heavy ball to the other. Each one will have their path altered due to the exchange of the ball. If the ball were invisible and you were just watching the two skaters, it would look like there was some force between them causing them to slightly repel each other. The diagram in Figure 2 shows how we now understand the Electromagnetic force between two charged objects, in this case two electrons. The Electromagnetic force particle is called the "photon". It is the particle

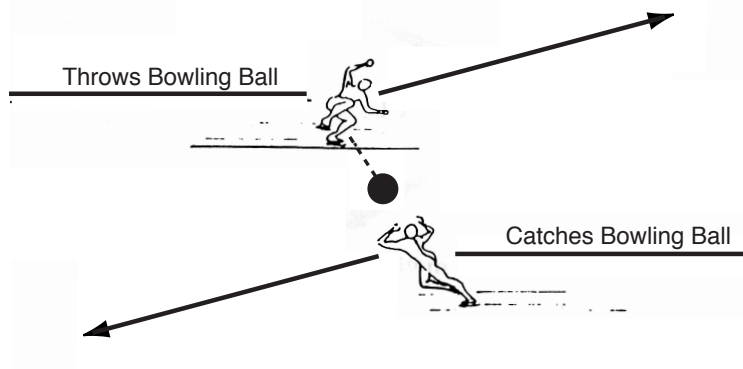

Figure 1

associated with electromagnetic waves which includes radio waves, microwaves, x-rays, and light. In order to have a force between two electrically charged objects, a photon must be exchanged. Such diagrams are known as Feynman Diagrams, named after their inventor, Richard Feynman, who was a Nobel Prize winner and one of the great physicists of the twentieth century.

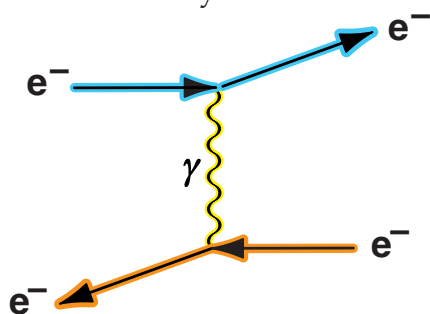

Figure 2

3.4 The Force Particles are called Bosons

Since we have four fundamental forces today, we have four fundamental force particles which are given the generic name "Bosons". While these differ in important ways as shown below, they have one property in common. They all have integer values of a basic unit of a quantity called "spin". Elementary particles can spin around an axis just as the earth spins around its axis. In terms of a basic unit of spin, all elementary particles have either integer (0, 1, 2, etc.) or half integer (1/2, 3/2, etc.) units of spin. Those particles with integer spin are known as "Bosons", while those with half-integer values are called "Fermions". We will come back to this when we talk about matter particles. Table 1 summarizes the four fundamental interactions and the properties of the corresponding force particles.

We see from the table that Gravity is the weakest of all forces in terms of its intrinsic strength. One way to understand the meaning of these relative strengths is to consider the gravitational and electric forces between two elementary particles such as protons (separated by a distance d). The ratio between these two forces can easily be calculated using the equations for the two force laws:

$$\text{Gravitational force } F_G = \frac{Gm_p^2}{d^2} \quad \text{and}$$

$$\text{Electric force } F_e = \frac{Ke^2}{d^2}$$

where G and K are the universal constants for the gravitational and electrostatic forces and m_p and e are the mass and electric charge of the proton. (Note that the ratio is independent of the distance between the two protons since both have the same $1/d^2$ dependence.)

This ratio of the gravitational force of attraction to the electric force of repulsion depends only on well known constants of nature and is approximately 10^{-36} , which is the same as the ratio of 10^{-38} to $1/137$, the intrinsic strengths from Table 1. This is an extremely small number, which tells us that Gravity is intrinsically much weaker than all the other forces. But, even so, if there is enough mass in a relatively small space, it can dominate over all other forces. This is what happens in a Black Hole.

Table 1. The Fundamental Interactions. The column labeled "Intrinsic Strength" shows how strong the forces are relative to the Strong Nuclear force. The mass unit of GeV for the Weak bosons is a commonly used unit for elementary particles. In this unit, the proton has a mass of about 1 GeV.

Force	Intrinsic Strength	Boson Name	Symbol	Mass	Charge	Spin
Strong	1.0	Gluon	g	0	0	1
Electromagnetic	1/137	Photon	γ	0	0	1
Weak	10^{-9}	Weak Boson	W^{\pm}, Z^0	~ 100 GeV	$\pm e, 0$	1
Gravitational	10^{-38}	Graviton	G	0	0	2

3.5 Electro-Weak Unification

Let us see if we can understand the unification of the Electromagnetic and Weak Nuclear forces. The information in Table 1 will help us. First we have to understand the mass units used in the Table. According to Einstein's famous equation $E=mc^2$, mass and energy are equivalent. When dealing with elementary particles, it is more meaningful to use this equation to give the very small masses of elementary particles in energy units instead of kilograms. For instance, the mass of a proton in kilograms is about 1.7×10^{-27} , which is a very small number, hard to put into perspective. On the other hand, in our energy unit the proton mass is very close to 1.0 GeV. But, the important use of the energy unit is to allow us to compare the mass energy of a particle to its kinetic energy of motion. When the kinetic energies of two particles with different masses are much greater than their mass energies, we can completely ignore the difference in masses as far as energy is concerned. Of course, if there are other properties that are different, e.g. electric charge, then that could make a difference as to how the particles would interact.

Now, let's look at Table 1. We see that the Z^0 boson and the photon (γ) have the same electric charge (0), but the former has a mass of 100 GeV while the latter is massless. This is essentially the basic difference between the two. At low energies (i.e. energies comparable or less than 100 GeV), this makes a huge difference in how the photon or the Z^0 would affect the interaction between, let's say, two electrons. But at energies that were available right after the Big Bang, much greater than 100 GeV, the Z^0 and photon would cause the same interaction between any two charged particles, as depicted in Figure 3. Thus, as far as the electrons in the figure are concerned, at high energies they would feel the same force from the exchange of a Z^0 or a photon.

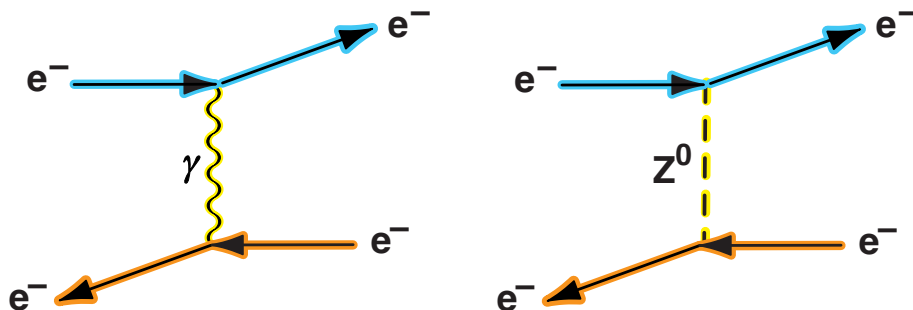

Figure 3

4 The Unification of Matter

As stated earlier, the question of the fundamental structure of matter dates back to the early Greeks. Figure 4 depicts a more modern view. We see that such small things as viruses are made up of molecules, which are made up of atoms, which are made up of electrons and a nucleus. The nucleus itself is made up of protons and neutrons, which are made up of entities called *quarks*. This picture could keep going, with the *quarks* being made up of something even smaller. But all the evidence we have today indicates that the *quarks* are indeed fundamental. This is an essential part of the Standard Model.

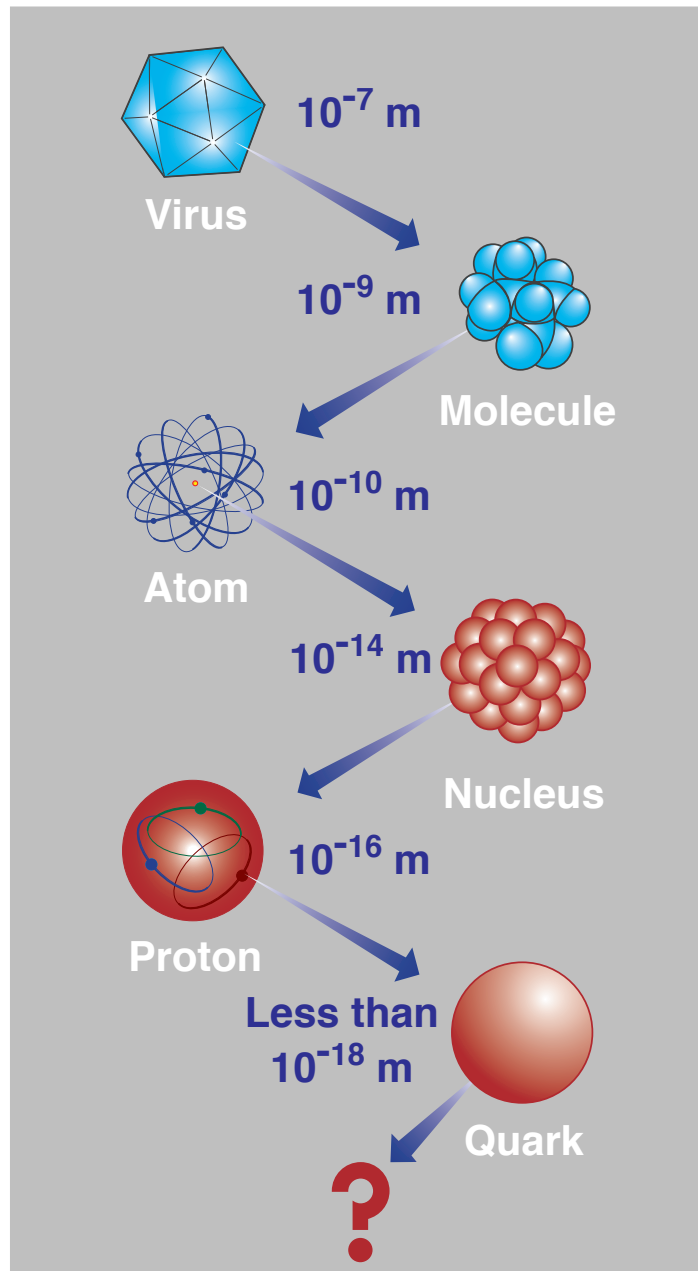

Figure 4

4.1 Two Classes of Fundamental Particles

Note that in the description above, electrons were not indicated as being composed of *quarks*. They are not. In fact, they, and other particles like them, form a separate class of fundamental particles. They are known as *leptons* which comes from the Greek *leptos* meaning fine or small. They interact via the Weak nuclear force. Since some of them are charged, like the electron, they also interact via the Electromagnetic force. Figure 5 shows a chart of the *quarks* and *leptons*. Let us consider the similarities and differences between these two types.

Matter Particles			Charge	
Leptons	$\begin{pmatrix} e \\ \nu_e \end{pmatrix}$	$\begin{pmatrix} \mu \\ \nu_\mu \end{pmatrix}$	$\begin{pmatrix} \tau \\ \nu_\tau \end{pmatrix}$	-1
				0
Quarks	$\begin{pmatrix} u \\ d \end{pmatrix}$	$\begin{pmatrix} c \\ s \end{pmatrix}$	$\begin{pmatrix} t \\ b \end{pmatrix}$	+2/3
				-1/3
+ <u>Anti-particles</u>				

Figure 5

4.1.1 Similarities

Both are Fermions (they all have a spin of 1/2 unit); there are six types (called flavors) of each and the flavors are grouped into three pairs of "families". For the *quarks*, the up and down *quark* flavors are in the first family; charm and strange form the second family and top and bottom the third. For the *leptons*, the electron and the electron neutrino form the first family, the muon and its neutrino the second and the tau and its neutrino the third.

Another similarity is that both *quarks* and *leptons* have anti-particles associated with them. Anti-particles are, in one sense, mirror images of their particle partners. For instance, the anti-electron has the identical mass as the electron but all other properties such as electric charge are opposite. So the anti-electron has a positive electric charge and, is in fact, called a positron. We will refer to anti-particles briefly below.

4.1.2 Differences

One of the basic differences is that *quarks* are never seen alone, but always are bound together in groups of two or three to form observable particles such as protons. On the other hand, leptons, e.g. the electron, are directly observable.

Electric charge provides another difference. The *leptons* in the upper row in figure 5, e, μ, τ , all have one unit of negative electric charge (the magnitude of the charge of the electron or proton is defined as the basic unit), while the neutrinos are uncharged. On the other hand, the upper *quarks*, u, c, t , all have +2/3 of the unit charge, while the lower *quarks*, d, s, b , all have -1/3 of the unit charge.

Finally, they also differ in their basic interaction. As stated above, the *leptons* interact through the Weak nuclear force. The *quarks* interact through the Strong nuclear force. Those *leptons* that are charged also interact through the Electromagnetic force. Most also

have mass, but we can neglect the Gravitational force since it is so minute compared to the others.

4.2 More about Quarks

One of the important differences pointed out above is that individual *quarks* are never observed alone. This is because the Strong Nuclear force is so strong that it prevents *quarks* from separating too far and getting free. *Quarks* only combine in two classes of observable particles.

In one pattern, the *quarks* combine in groups of three, forming particles known as *baryons* which comes from the Greek word *barus* meaning heavy. Both protons and neutrons are *baryons*. The proton is made of two *up quarks* and one *down quark* (note that the charges of the three *quarks*, $2/3 + 2/3 - 1/3$, add up to one unit of charge). The neutron, on the other hand, is made up of two *down quarks* and one *up quark* (its total charge $2/3 - 1/3 - 1/3$ is zero). Figure 6 shows a representation of the proton, with the *quarks* being held together by the exchange of *gluons*.

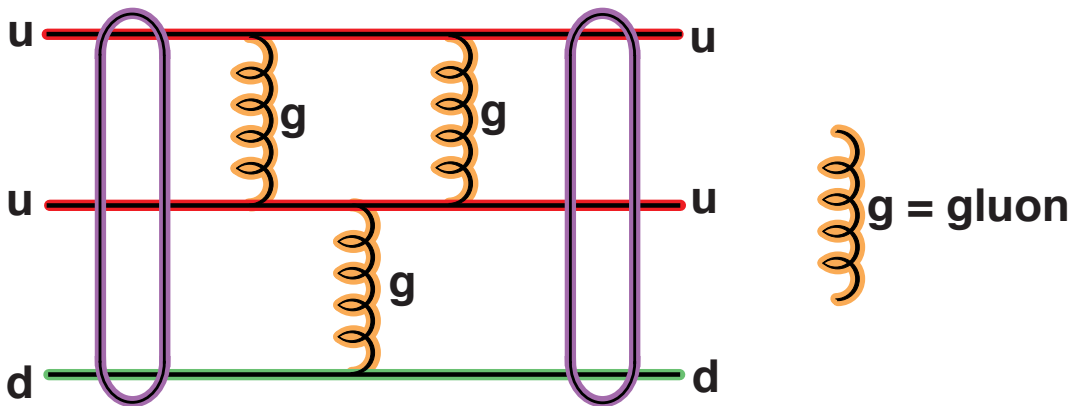

Figure 6

The other combination pattern is where a *quark* and an *anti-quark* combine to form particles known as *mesons*, from the Greek word for middle. These particles are not as familiar to us as protons and neutrons, and are only observed when produced in particle accelerators or in cosmic rays. Their masses tend to be less than that of *baryons*.

4.3 More about Leptons

As stated above, *leptons* interact via the Weak nuclear force. The e , μ and τ *leptons*, having electric charge, also interact via the Electromagnetic force. Since that force is so much greater than the Weak nuclear force, it dominates their interactions. On the other hand, the neutrinos, all having no charge, interact only through Weak nuclear force. Since this force is so weak, neutrinos hardly interact at all. This has important consequences for us. Electron neutrinos are copiously produced in nuclear reactions that fuel all burning stars, including, of course, our sun. Since they hardly interact, they escape from the sun depositing very little if any of their energy back into the sun. This,

in fact, is the main mechanism for star cooling. If the neutrinos interacted more, additional energy would be deposited in the star causing it to burn faster. If this were true for our sun, it would have burned up all its fuel by now and would be a dead star. In other words, we could no longer exist, at least here on earth. So, the existence of weakly interacting neutrinos is very important to us.

4.4 A Mystery

Just about all of the observed matter in the universe is composed of atoms, which in turn, are made up of electrons, protons and neutrons. The latter two are composed of *up* and *down quarks* only. In addition, we have just discussed the importance of electron neutrinos. It would appear that the universe only requires four fundamental particles: *up* and *down quarks*, the electron and the electron neutrino. So, why does nature need four other *quarks* and four other *leptons*? At this time, we do not know the answer. It is one of the mysteries that particle physicists are trying to unravel.

Particle Physics Flowchart

