

Constraining Cosmology using the Growth of Structure and the Cosmic Microwave Background

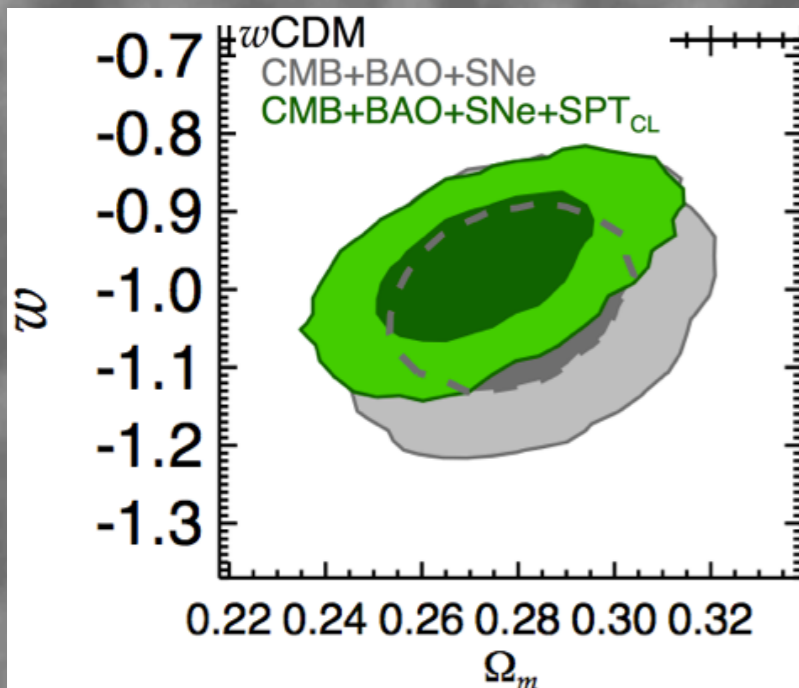

Bradford Benson
(University of Chicago)

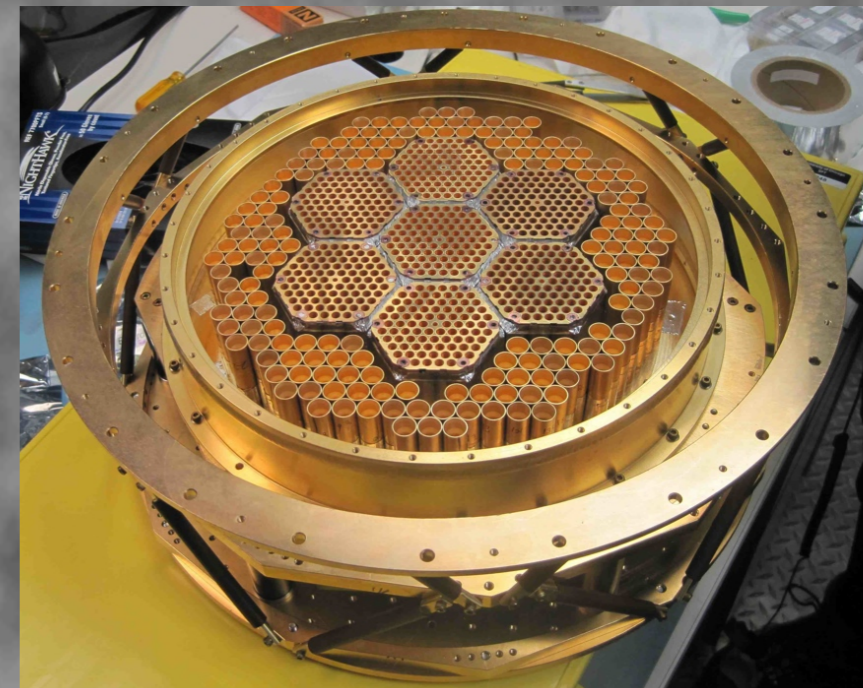

Pillars of Modern Cosmology

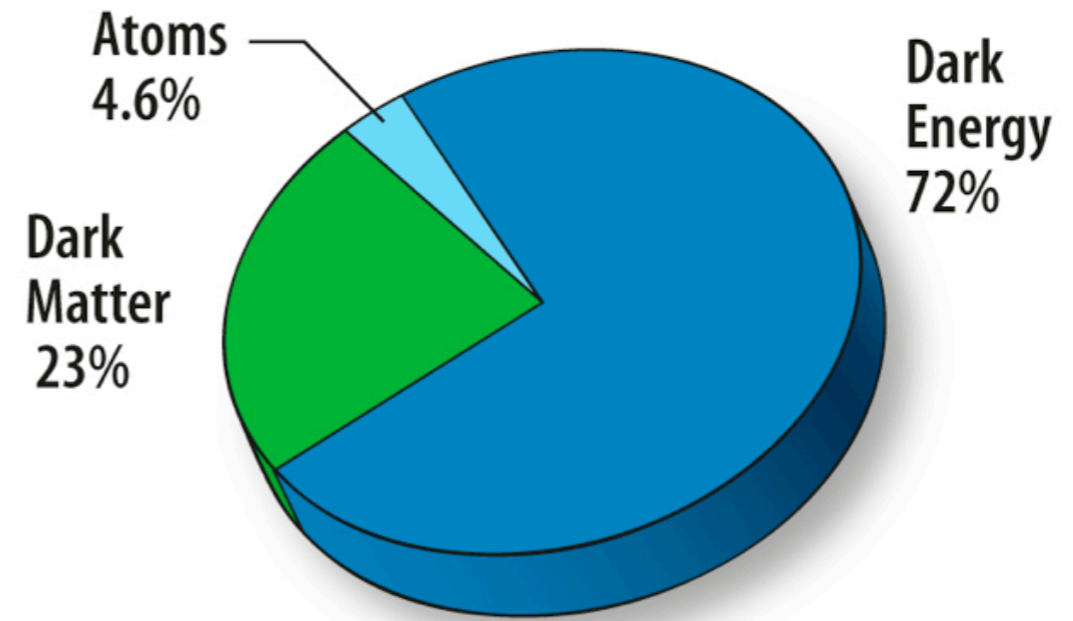

1. Dark Energy

2. Dark Matter

3. Inflation

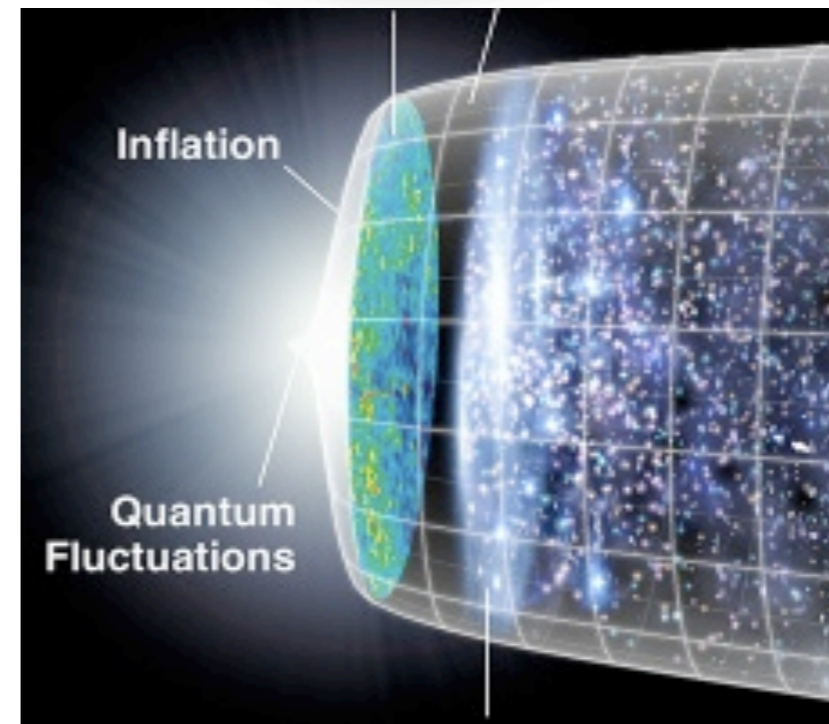

All three imply new physics (and all three raise fundamental questions!)

Big Questions Remain!

1. Dark Energy

- What drives cosmic acceleration? Vacuum energy? Do its properties evolve with redshift? Is General Relativity correct on large scales?

2. Dark Matter

- Particle-based explanation for dark matter? What are they: WIMPs, axions, etc.? Remaining questions for neutrinos: How massive? and how many species?

3. Inflation

- Can we observationally confirm Inflation? What physics was responsible for it? What other paradigm can replace it?

The CMB as a Backlight to the Universe

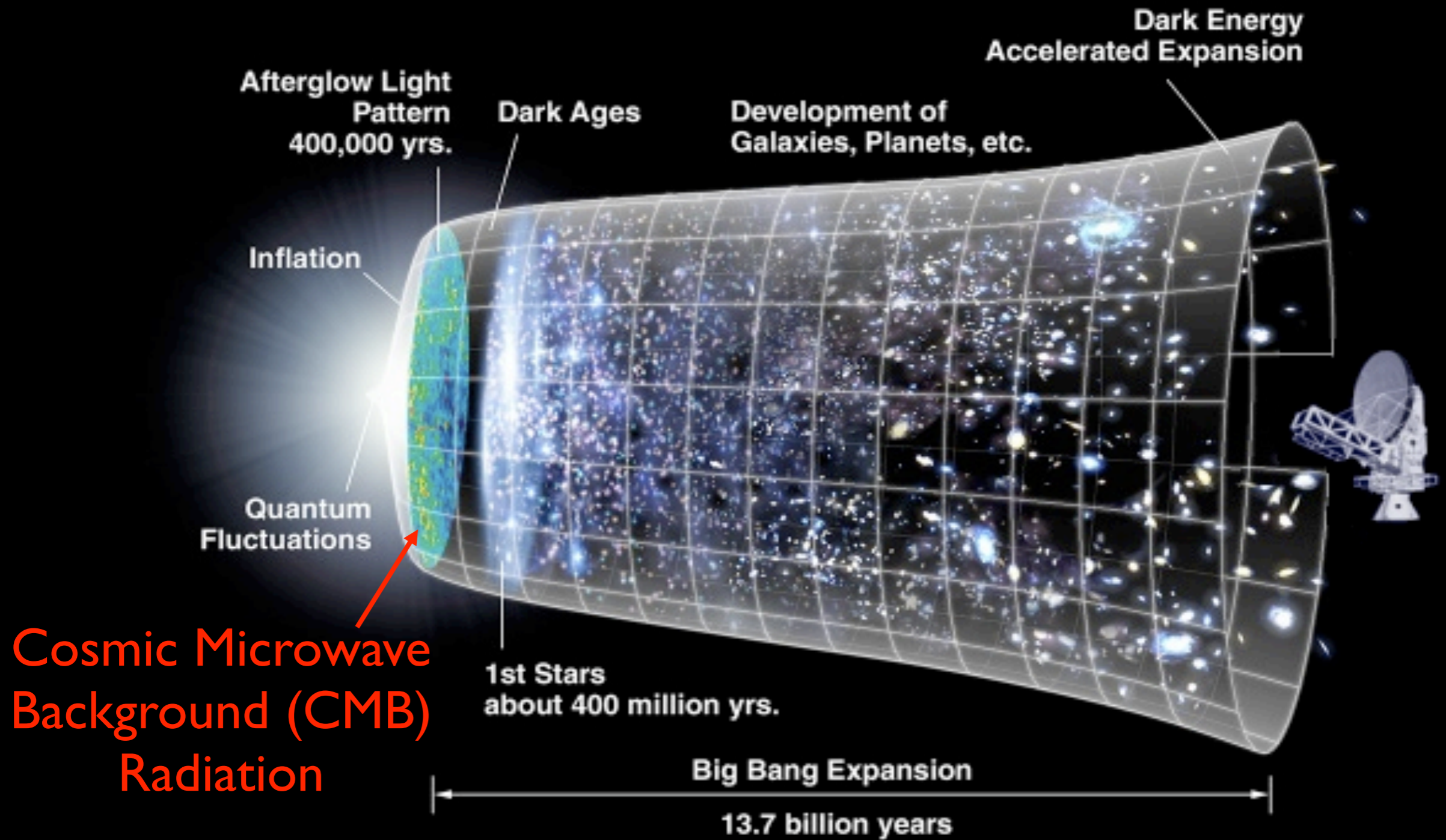

(image modified from
NASA/WMAP)

Structure Formation in the Universe

Cosmic Microwave Background

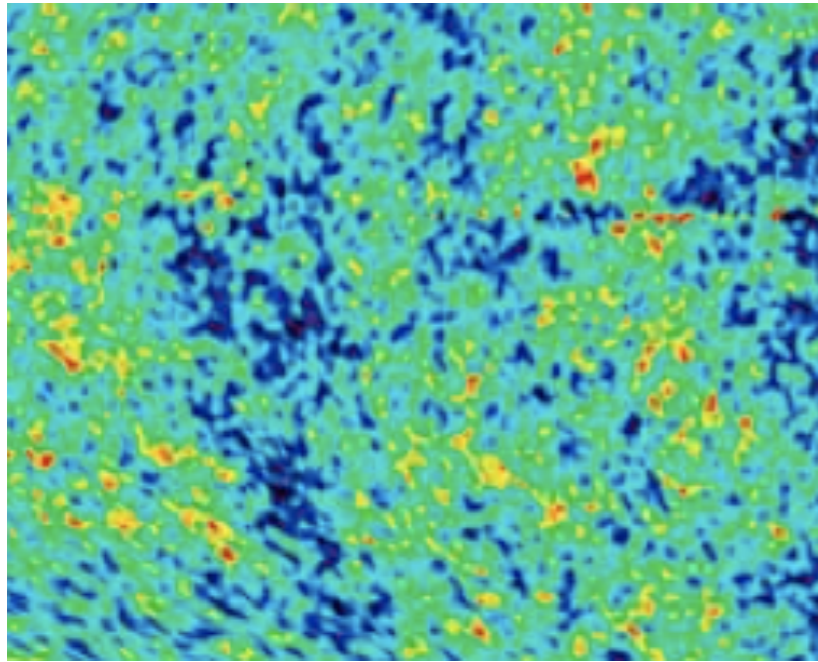

~400,000 years

Structure Formation

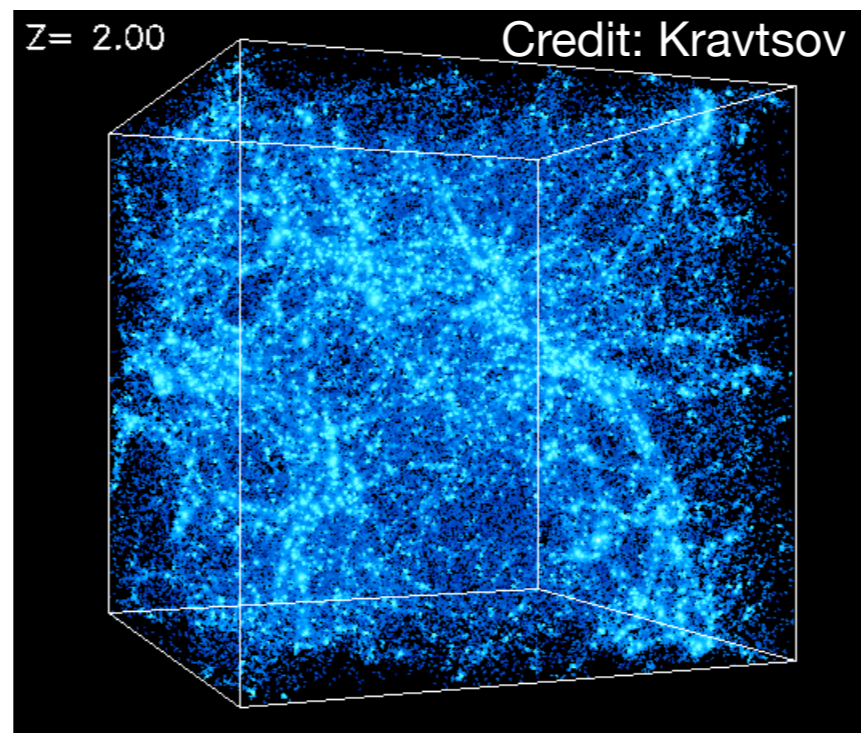

~3 billion years

Galaxies and Clusters of Galaxies

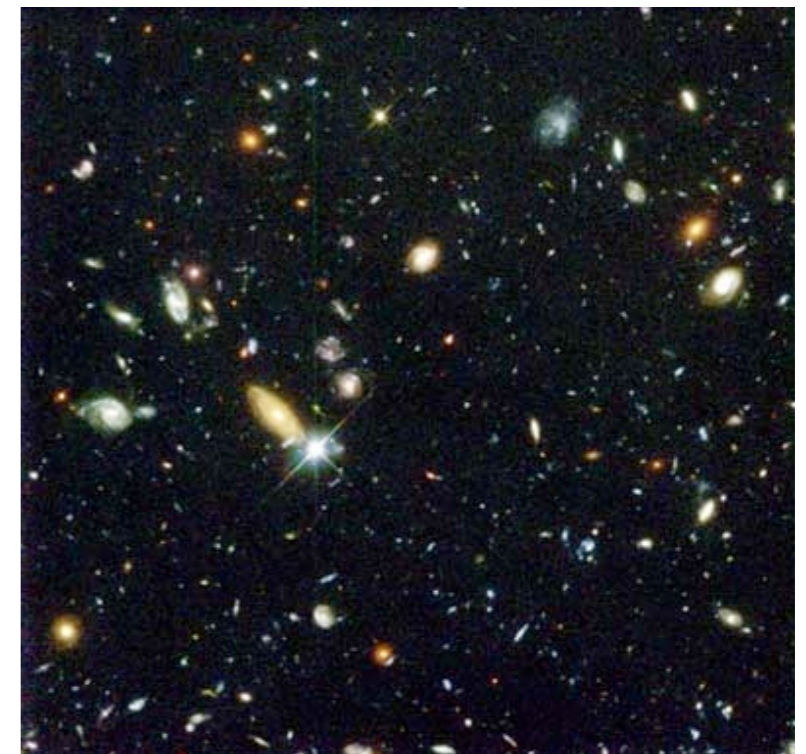

~13.7 billion years

The CMB Measures Structure Formation

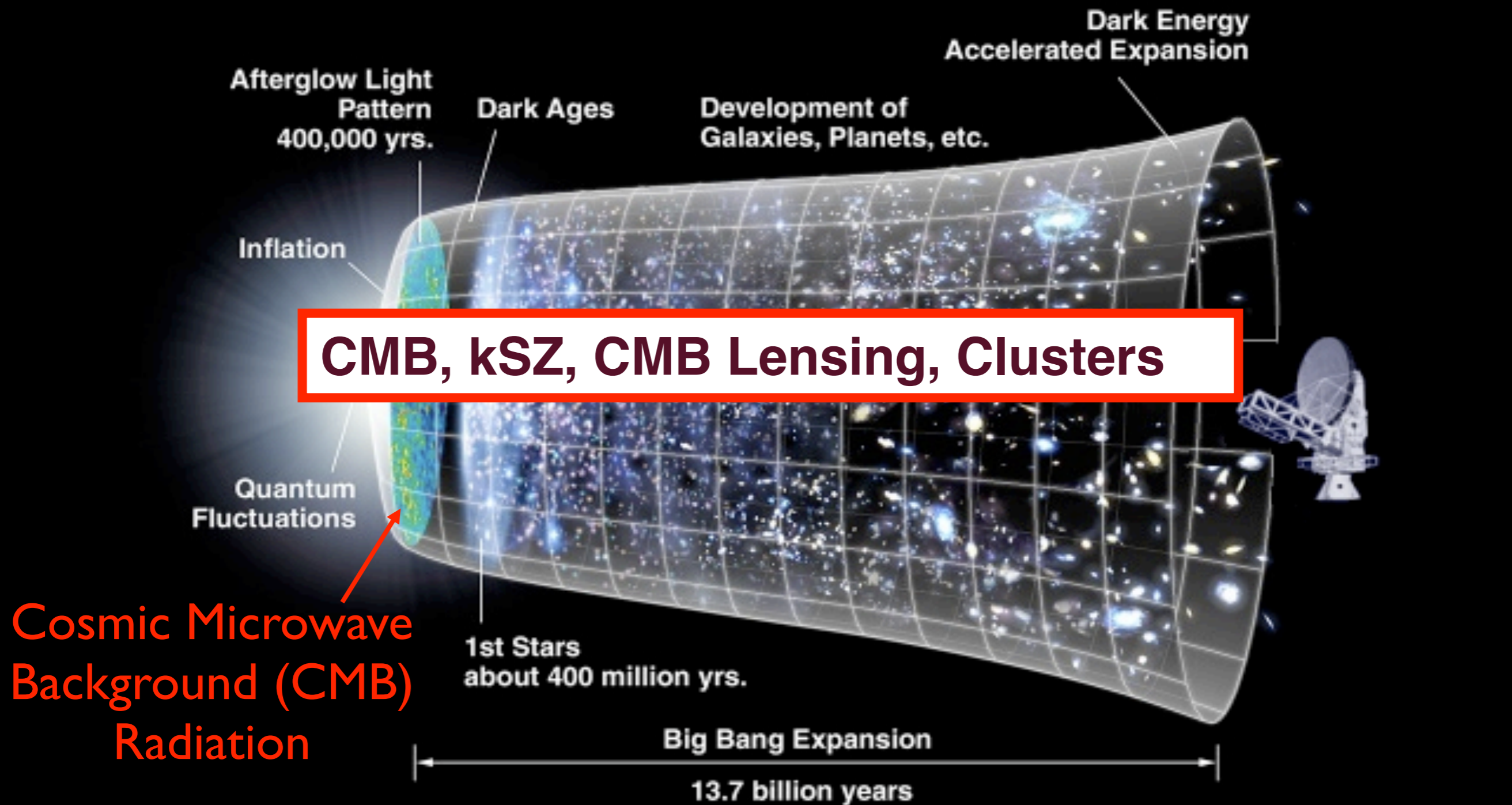

(image modified from NASA/WMAP)

Cosmological Parameters

1. Dark Energy

- Ω_Λ , dark energy density
- w , dark energy equation of state
- w_a , evolution of dark energy

2. Dark Matter

- Ω_m , dark matter density
- Σm_ν , sum of neutrino masses
- N_{eff} , number of relativistic species

3. Inflation

- n_s , scalar tilt
- r , tensor-to-scalar ratio
- f_{NL} , non-gaussianity

Cosmological Parameters

1. CMB Anisotropy

2. Clusters

3. CMB Lensing

1. Dark Energy

- Ω_Λ , dark energy density
- w , dark energy equation of state
- w_a , evolution of dark energy

2. Dark Matter

- Ω_m , dark matter density
- Σm_ν , sum of neutrino masses
- N_{eff} , number of relativistic species

3. Inflation

- n_s , scalar tilt
- r , tensor-to-scalar ratio
- f_{NL} , non-gaussianity

Cosmological Parameters

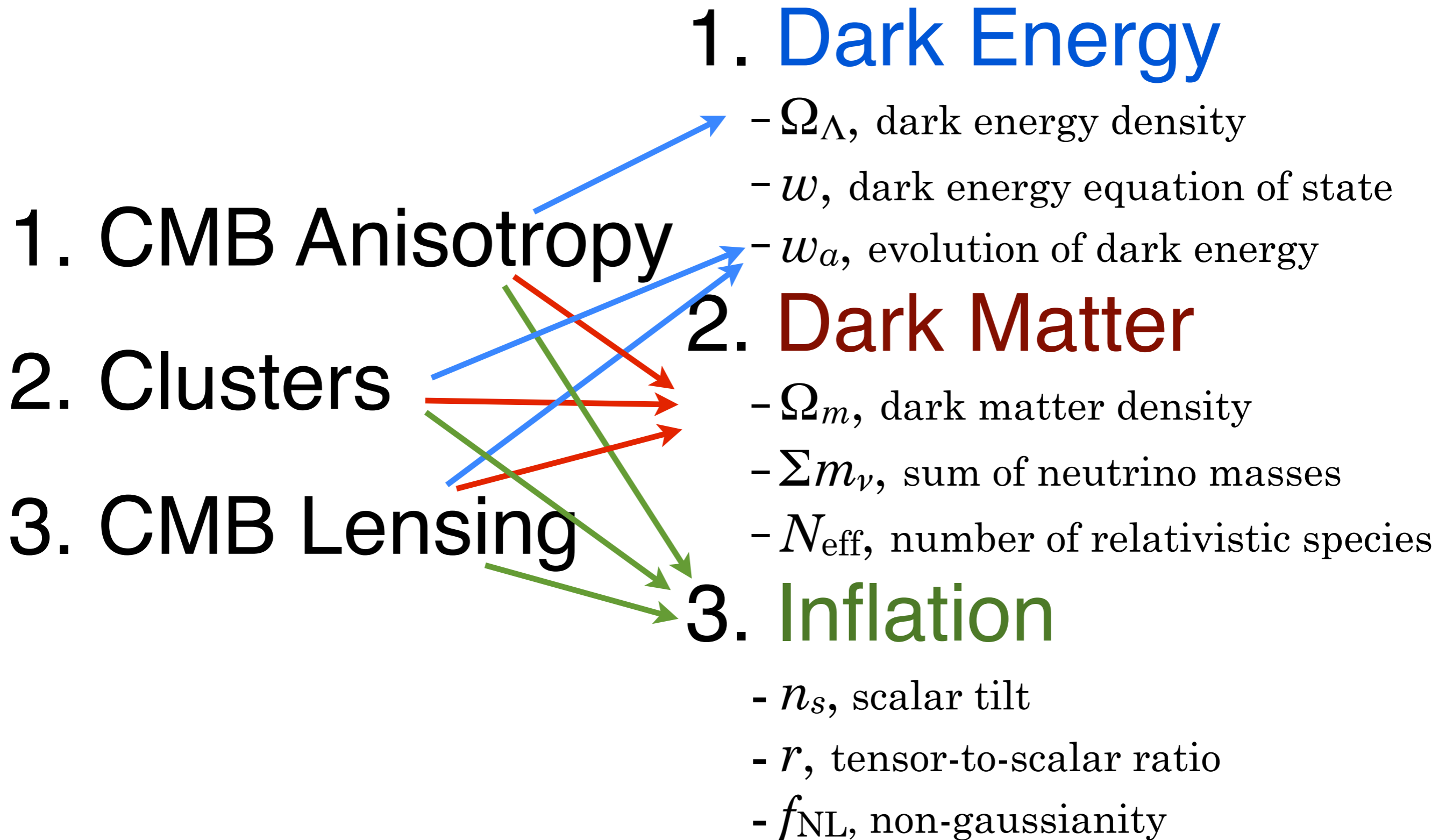

The South Pole Telescope (SPT)

Millimeter-Wavelength Telescope

- 10 meter primary mirror
- 1 deg² field of view

SPT-SZ Receiver Camera

- ~960 bolometers
- 3-colors: 100, 150, 220 GHz
- Resolution of 1.6, 1.2, 1.0 arcmin (well-matched to high- z clusters, r_{500} ($z=1.0$) ~ 2 arcmin)

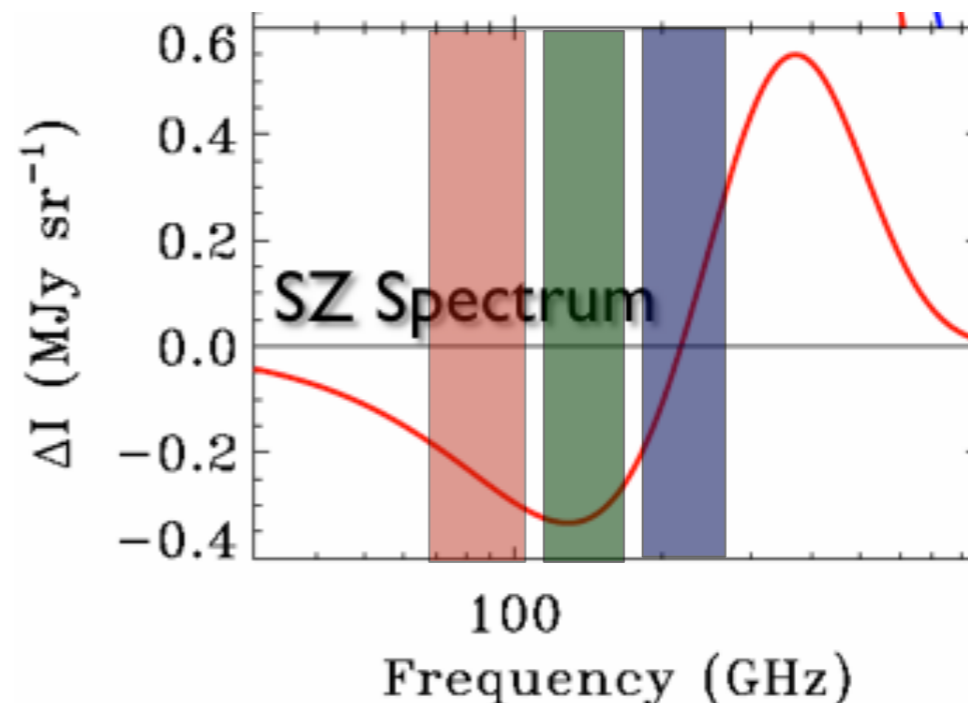
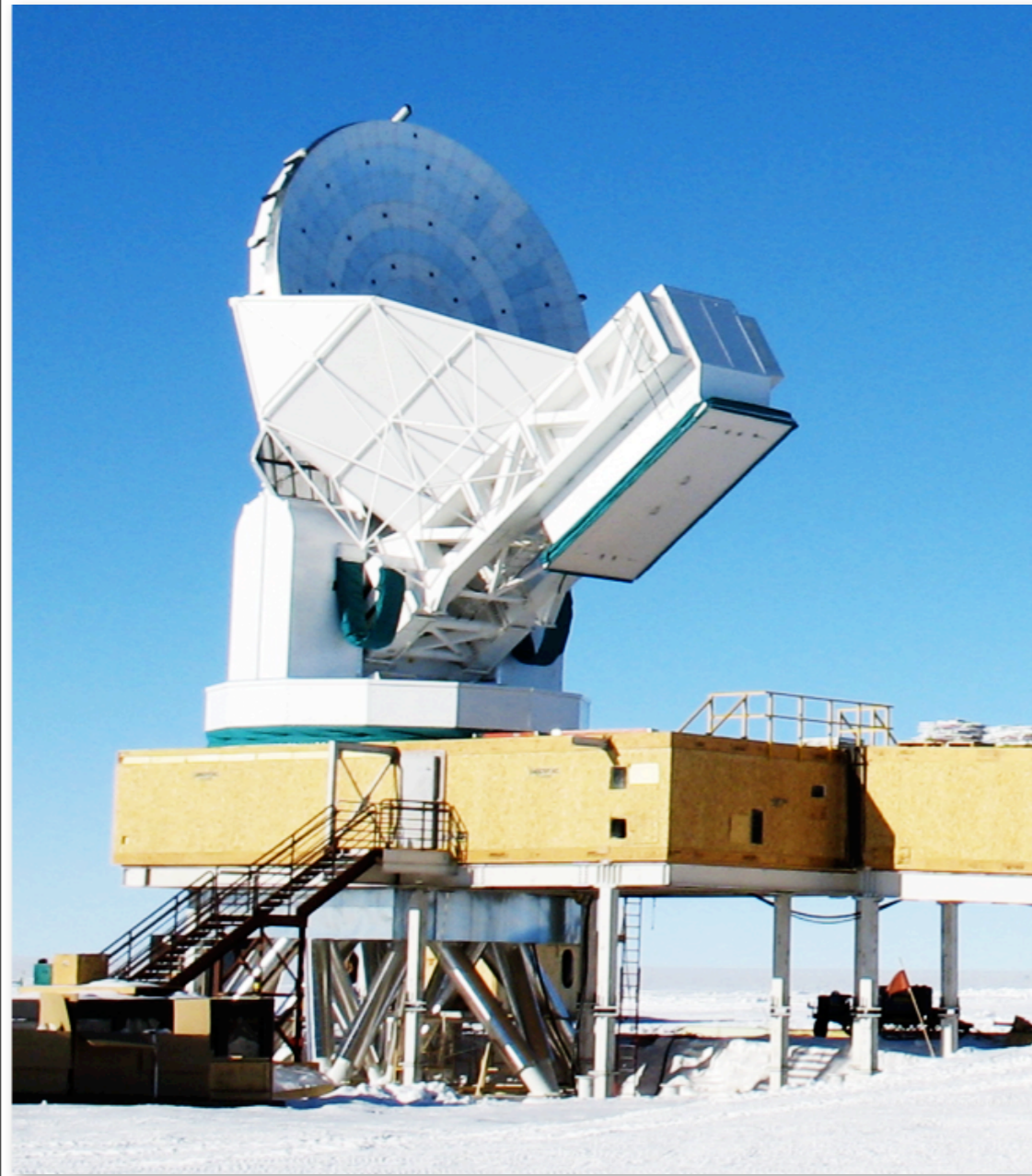

Funded by
NSF



Why Observe the CMB from the South Pole?

SPT

South Pole Environment

- Extremely Dry
 - Percipitable Water Vapor in Winter is $\sim 4x$ < than Chile, $\sim 6x$ < than Hawaii
- High Altitude ($\sim 10,000$ ft)
- Stable (no diurnal variations)
- Low peak wind-speed

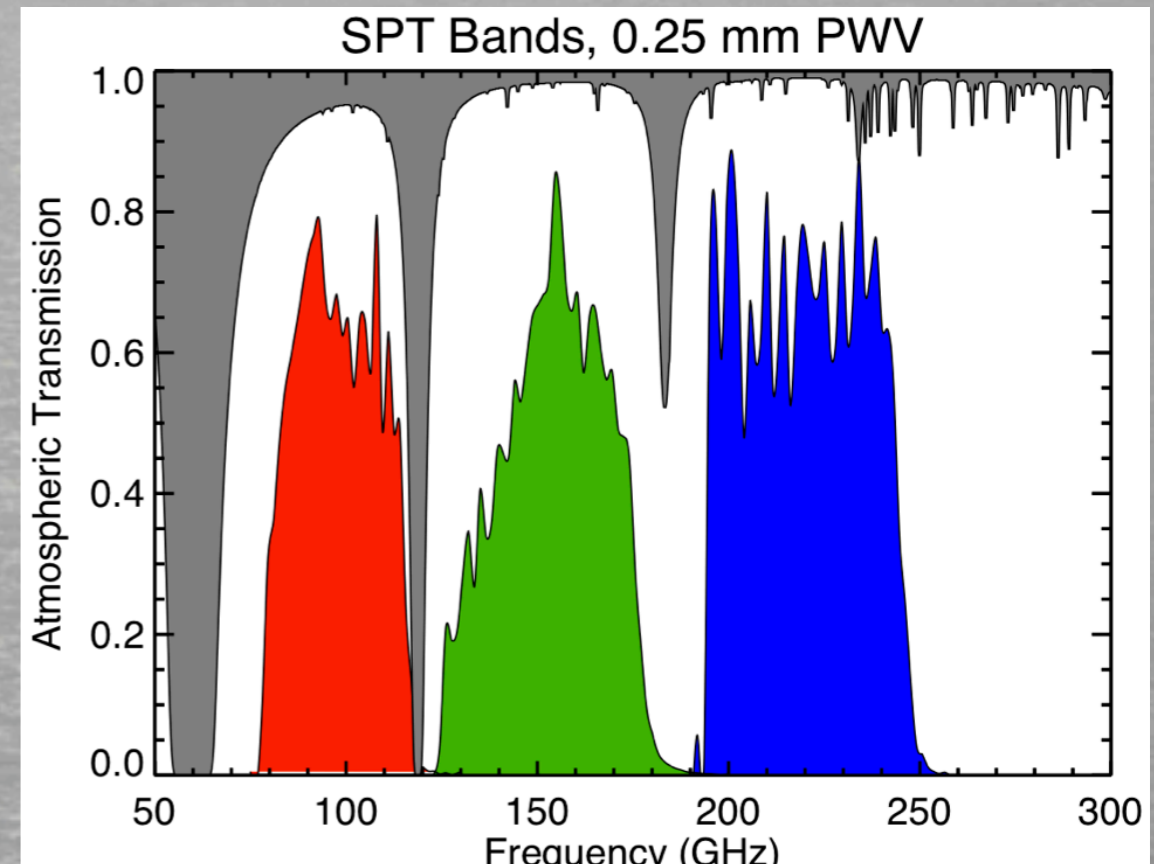

Why Observe the CMB from the South Pole?

SPT

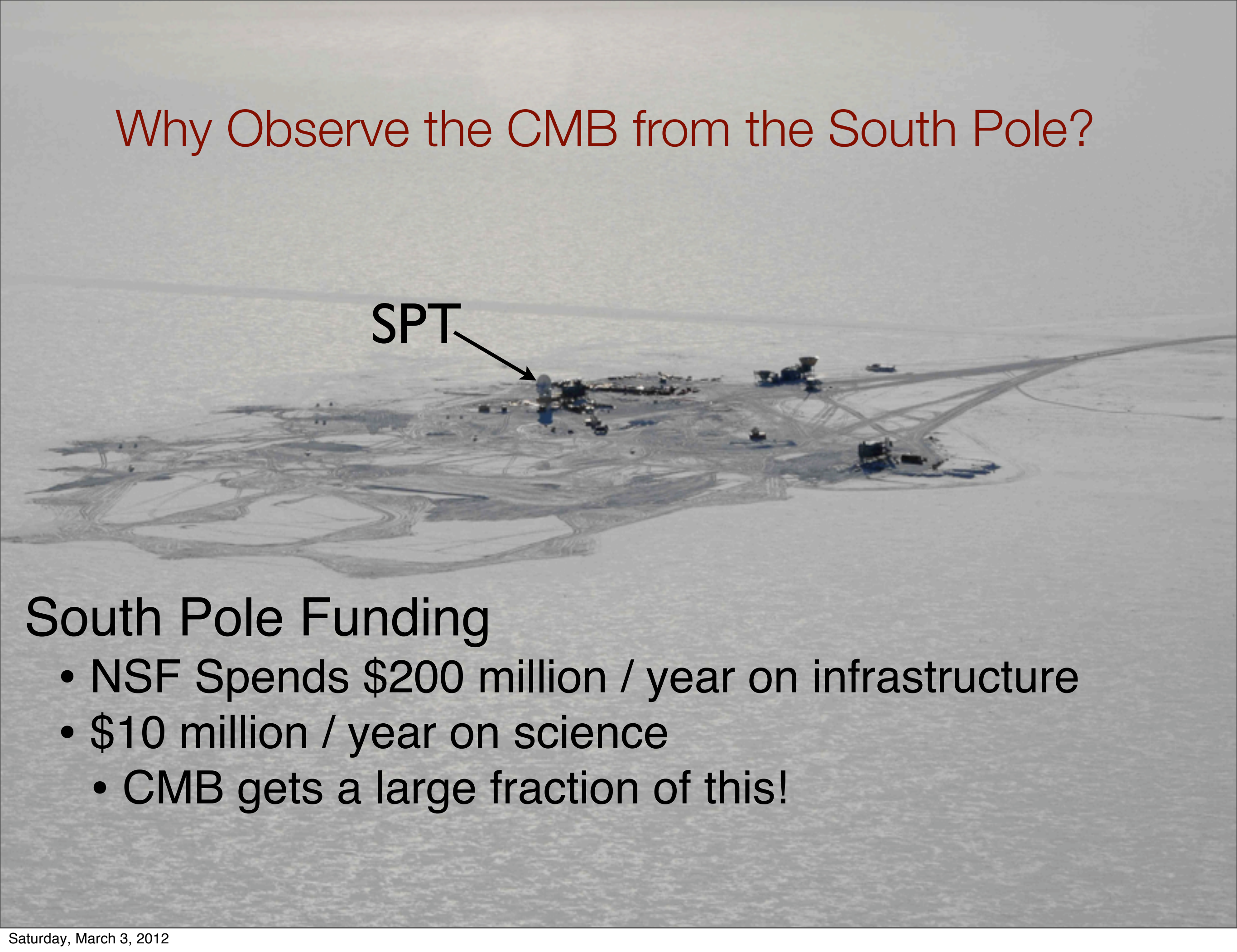
An aerial photograph of the South Pole station, showing various buildings and infrastructure on a vast, flat, snow-covered landscape. A black arrow points from the text 'SPT' to a specific structure in the center of the station.

South Pole Funding

- NSF Spends \$200 million / year on infrastructure
- \$10 million / year on science
 - CMB gets a large fraction of this!

The South Pole has led ground-based measurements of the CMB for the past decade

SPT (2007-2011)

SPT_{pol} (2012-2014)

SPT_{pol2} (?)

SPT-submm (?)

DASI (1999-2003)

QUAD (2004-2007)

KECK (2011-2014)

ACBAR (2001-2005)

BICEP (2006-2008)

BICEP2 (2010-2012)

POLAR-1 (2014-?)

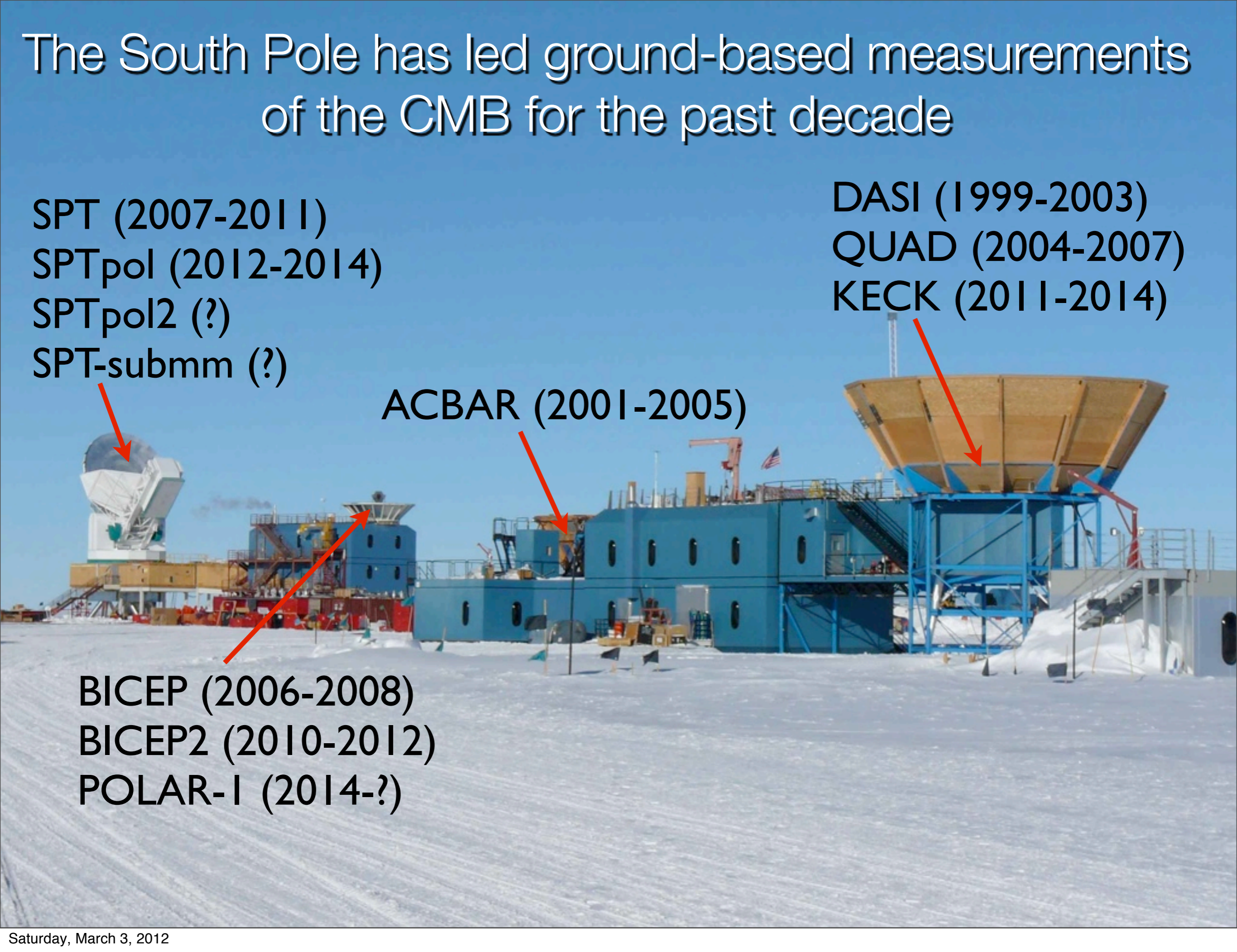

The 2500 deg² SPT-SZ Survey

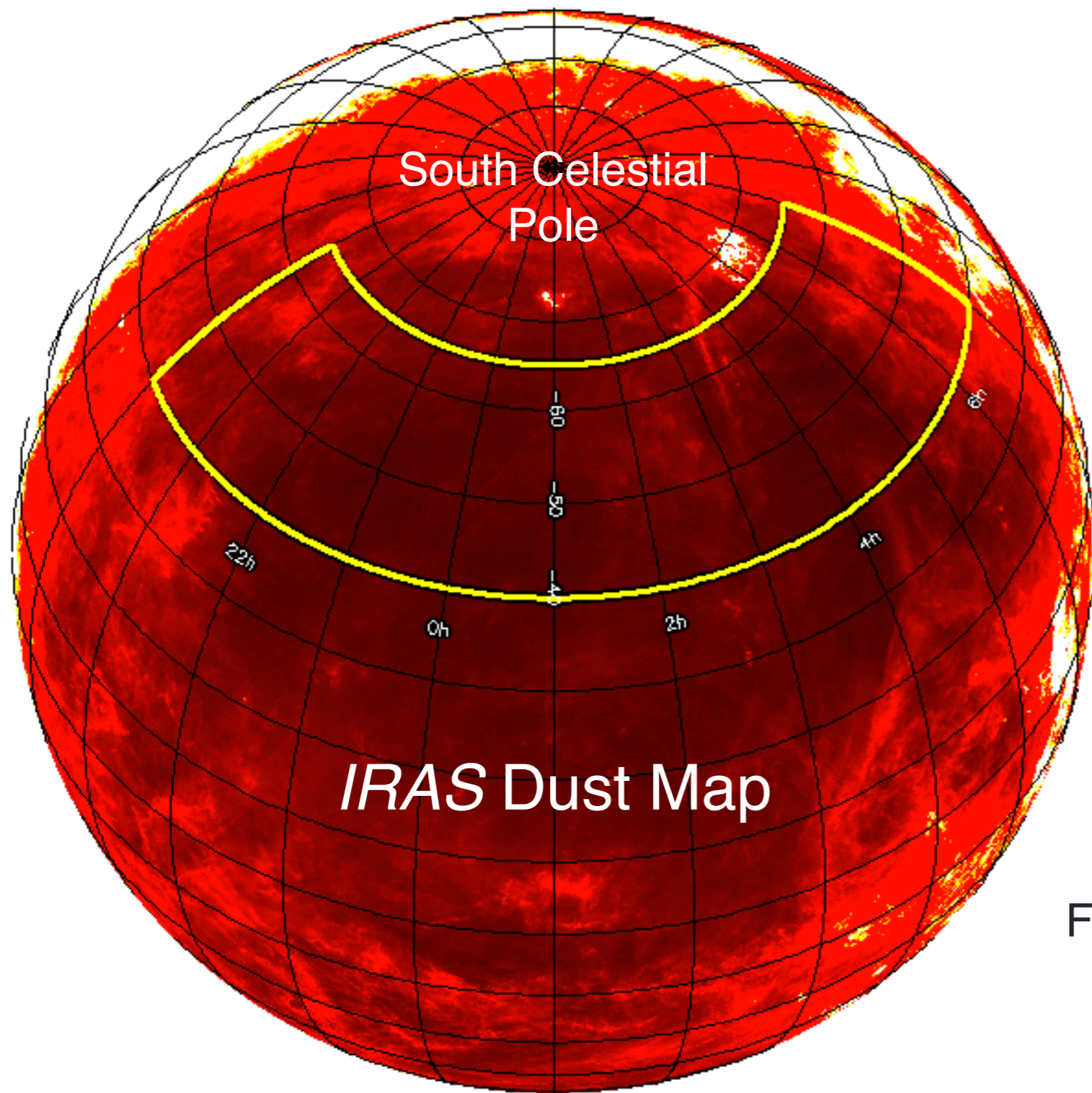

- 2500 deg² at high galactic latitude in Southern Sky.

- **Status:** 5-year survey finished (!!!)
Nov. 2011

Final survey depths of:

- 90 GHz: 42 $\mu\text{K}_{\text{CMB-arcmin}}$
- 150 GHz: 18 $\mu\text{K}_{\text{CMB-arcmin}}$
- 220 GHz: 85 $\mu\text{K}_{\text{CMB-arcmin}}$

(In these units, tSZ is 1.7 times brighter at 90 GHz than at 150 GHz.)

WMAP

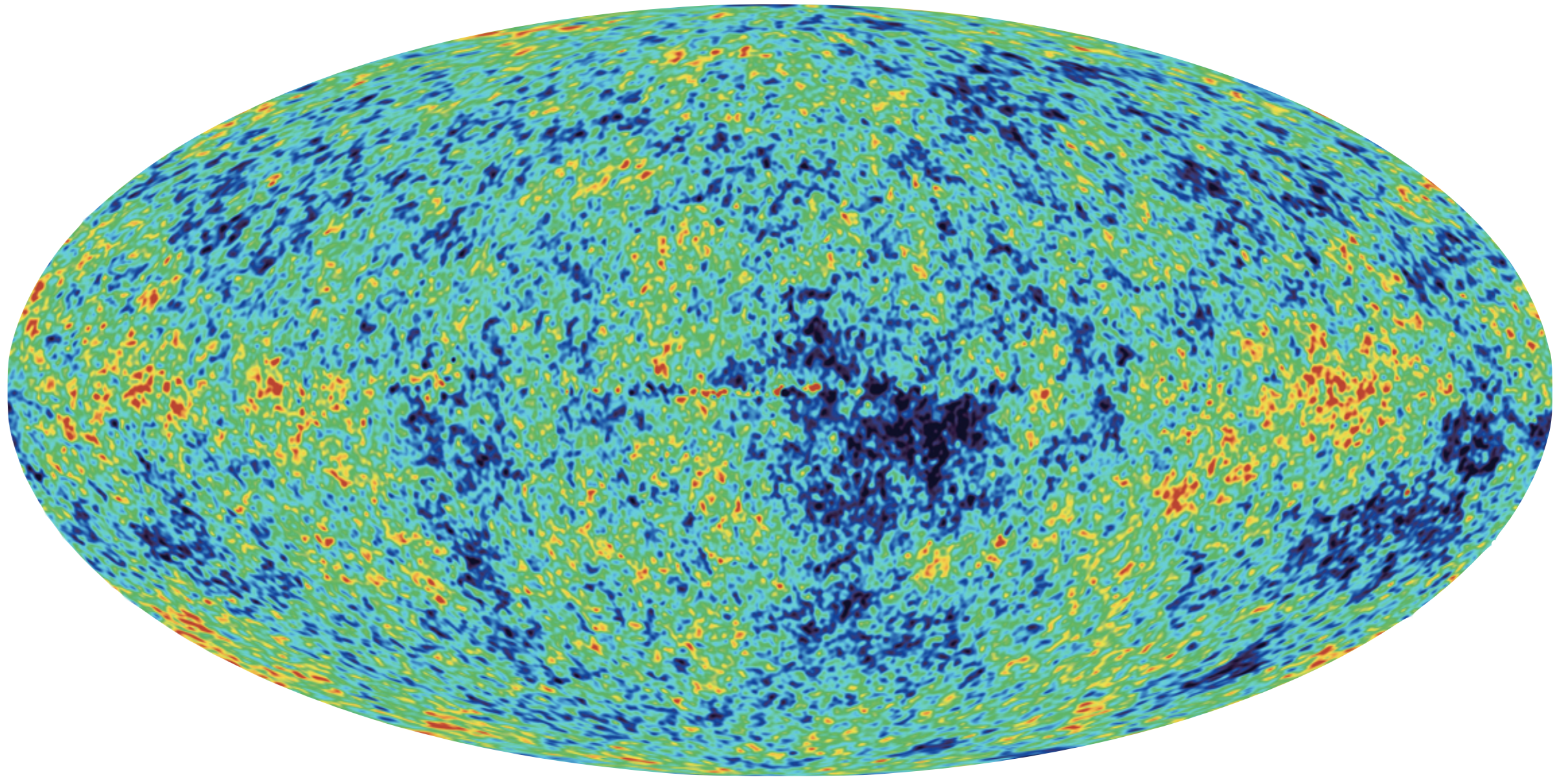

WMAP

230 deg²
(9% of SPT survey)

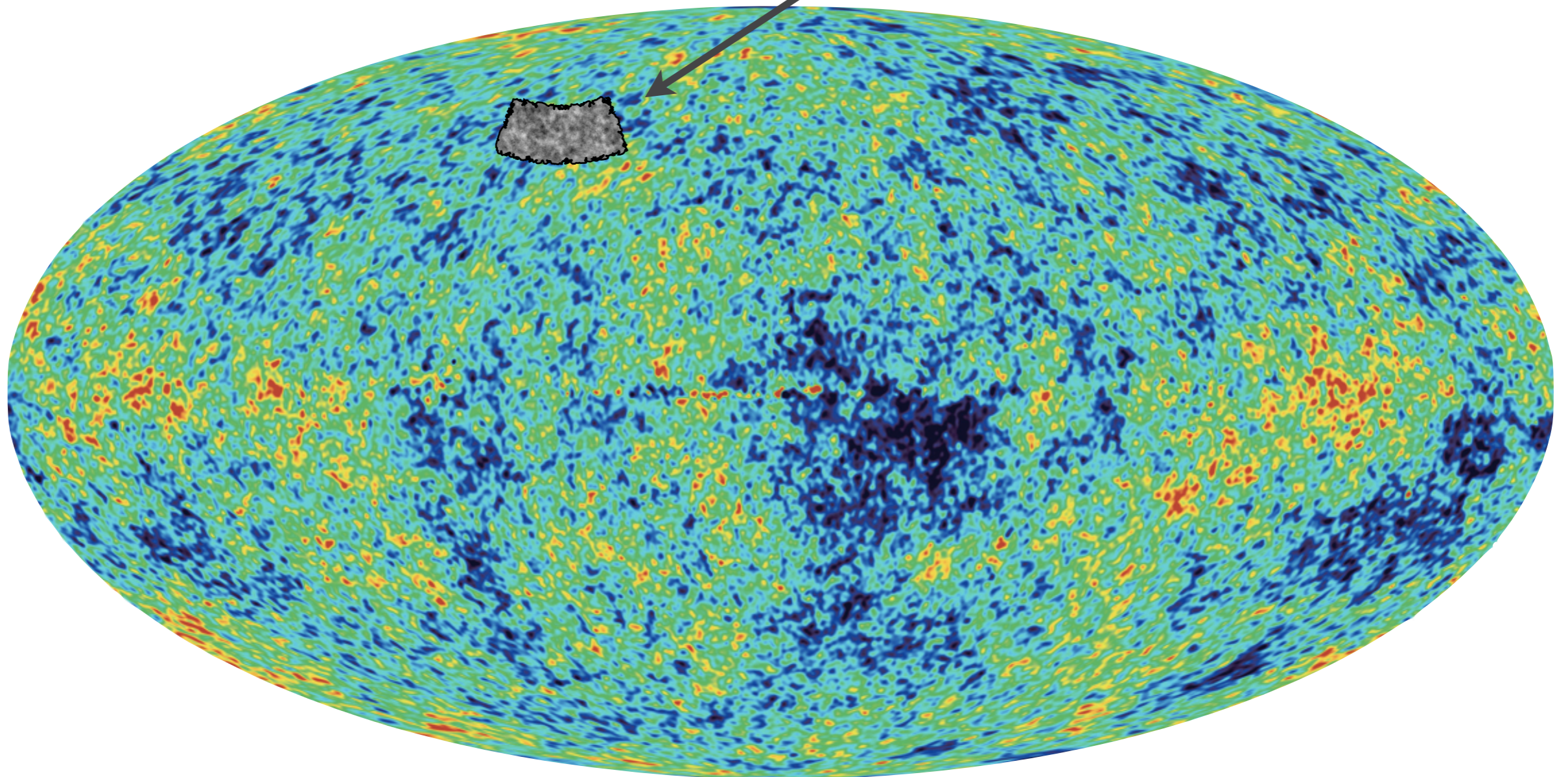

WMAP

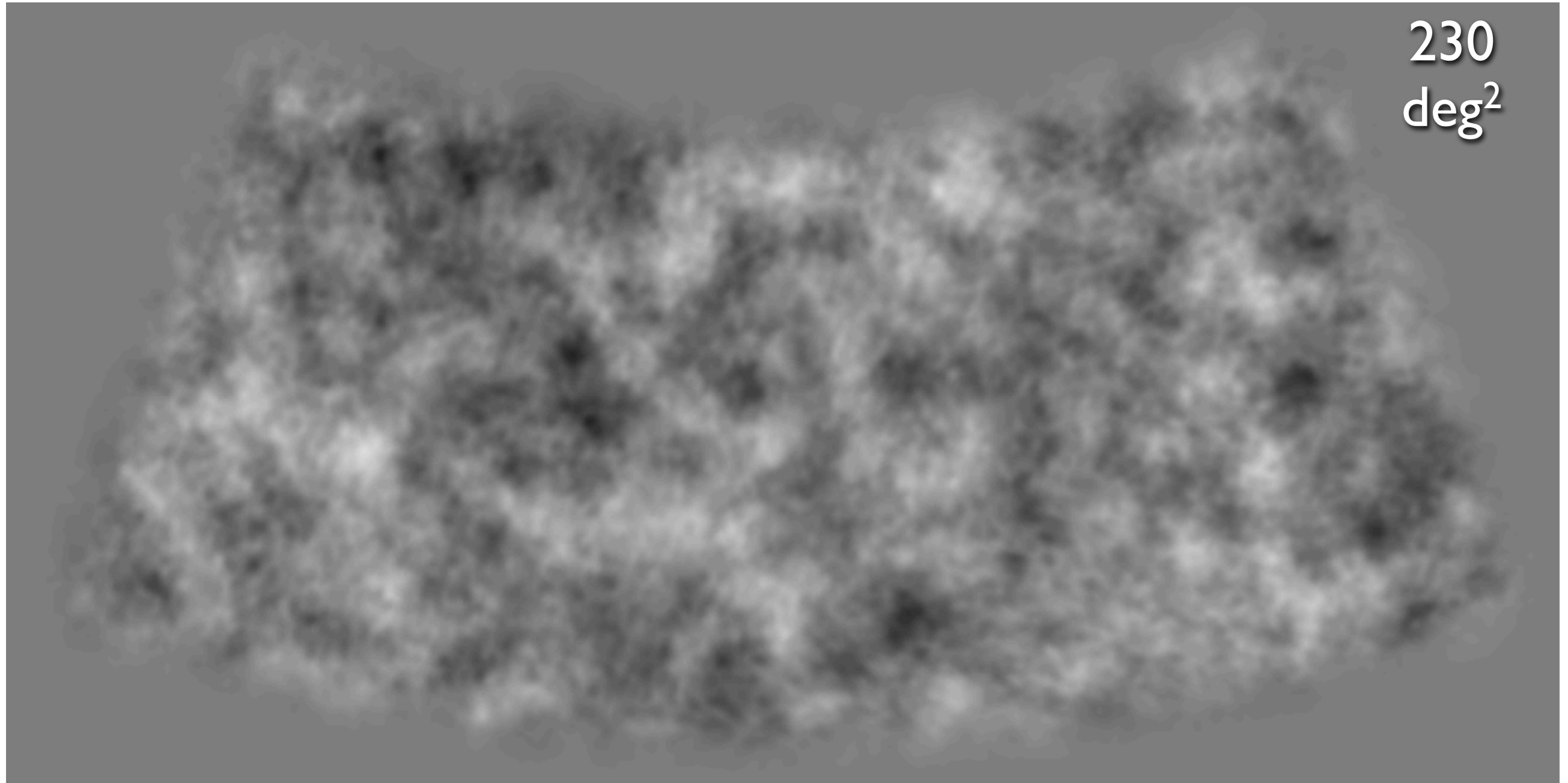

SPT

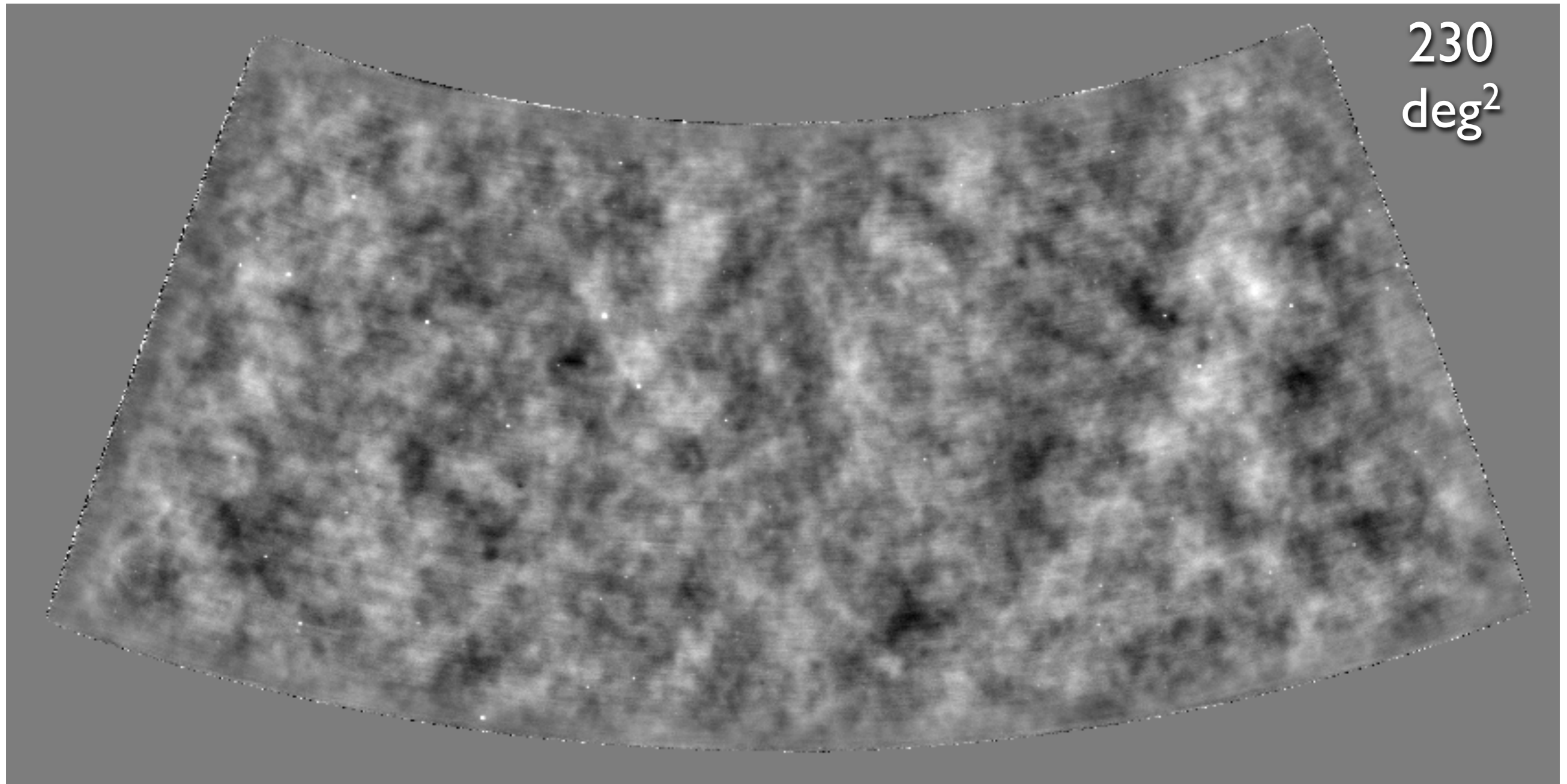

13x smaller beam (13' vs 1')

17x deeper (300 uK-arcmin vs 18 uK-arcmin)

Evolution of Detector Focal Planes

2001: ACBAR
16 detectors

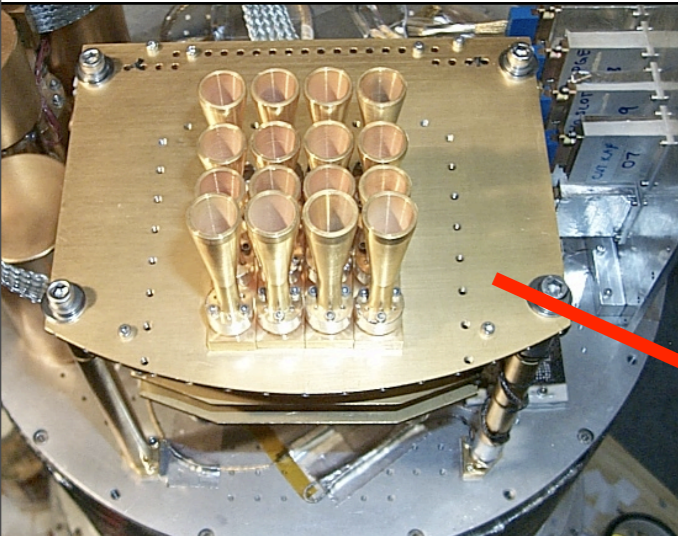

2005: BICEP
~100 detectors

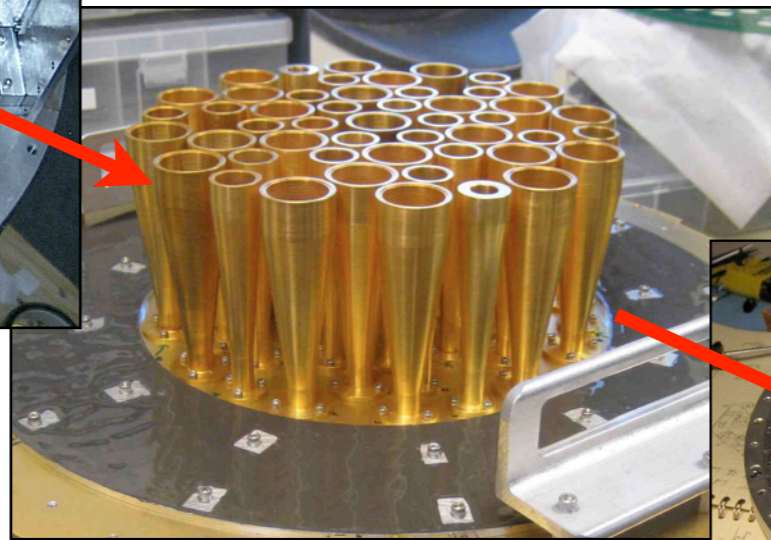

2007: SPT
960 detectors

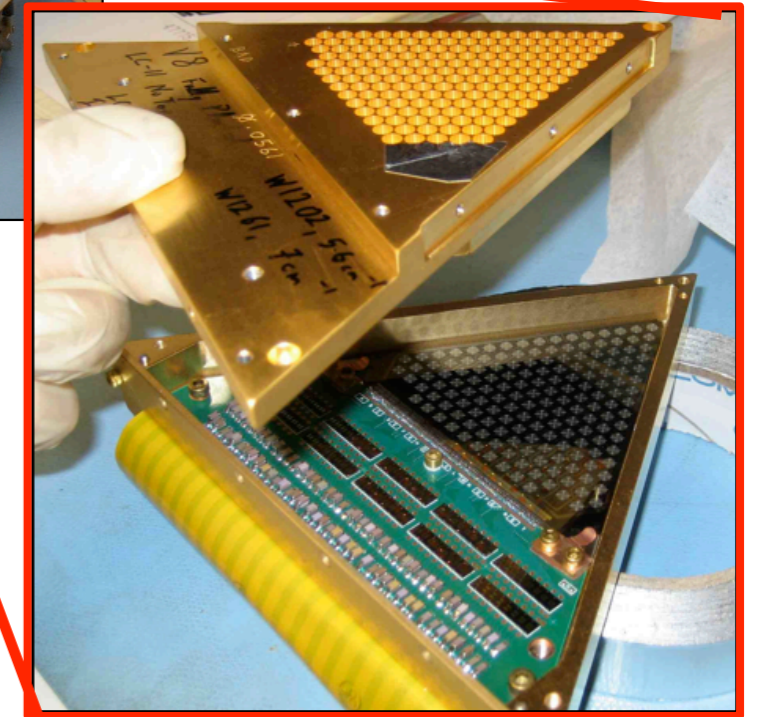
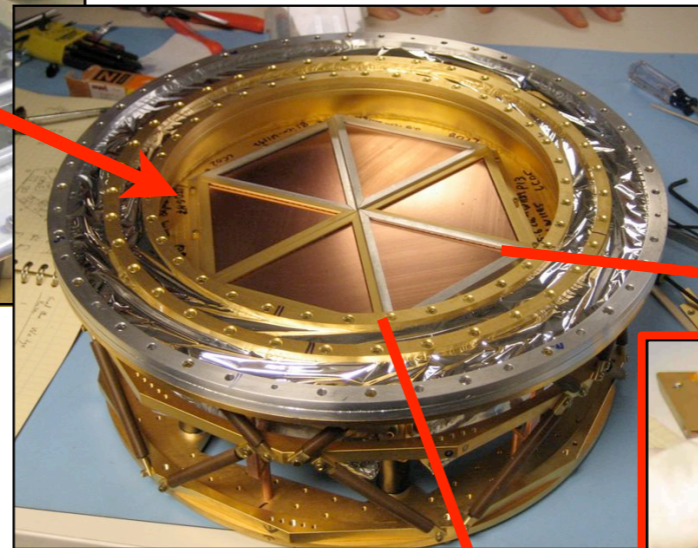

ACBAR was the first experiment to make a “background limited” detector, since then we’ve just been trying to make more of them

SPT Receiver

- Built at UC-Berkeley
 - an effort that I lead from 2004-2008
- Required development of several key technologies:

- 1) **Pulse Tube Coolers**
- 2) **Superconducting (TES) bolometers**
- 3) **Large format bolometer arrays**
- 4) **Multiplexed low-noise SQUID readout electronics**

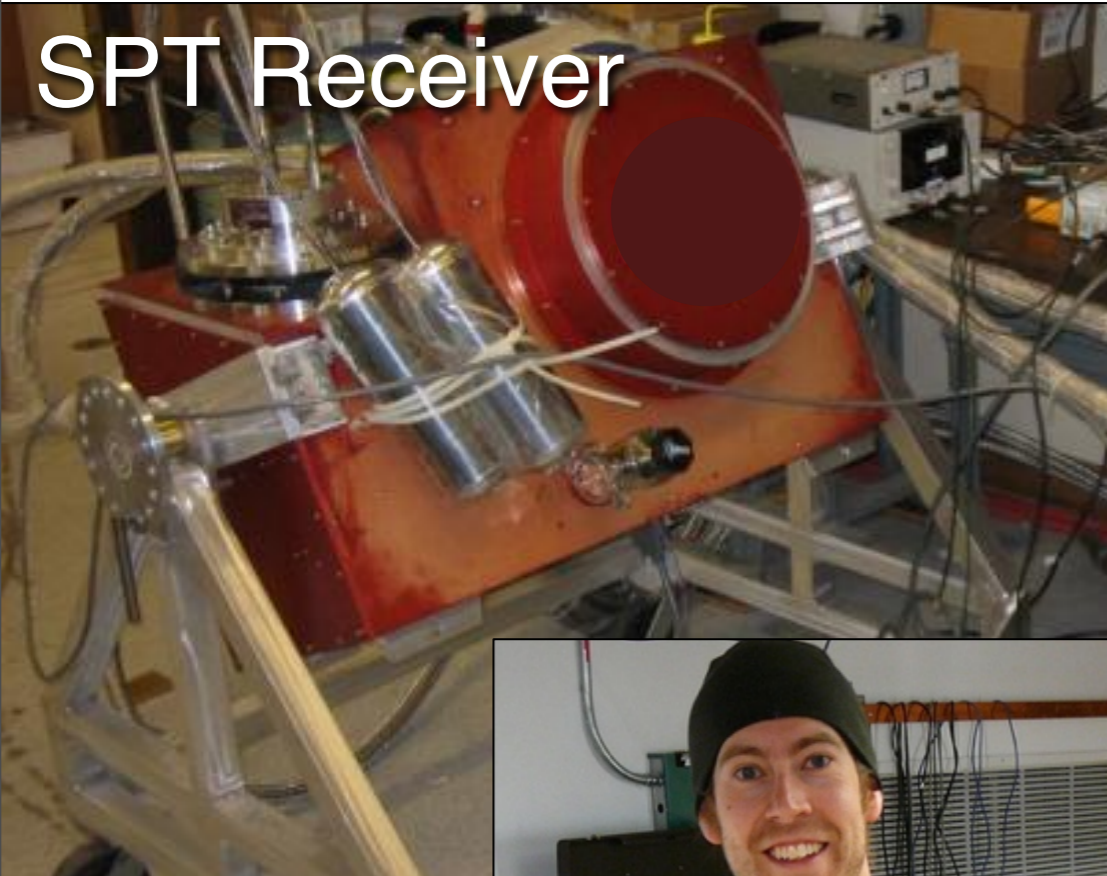

SPT Focal Plane

SPT Detector Wafer

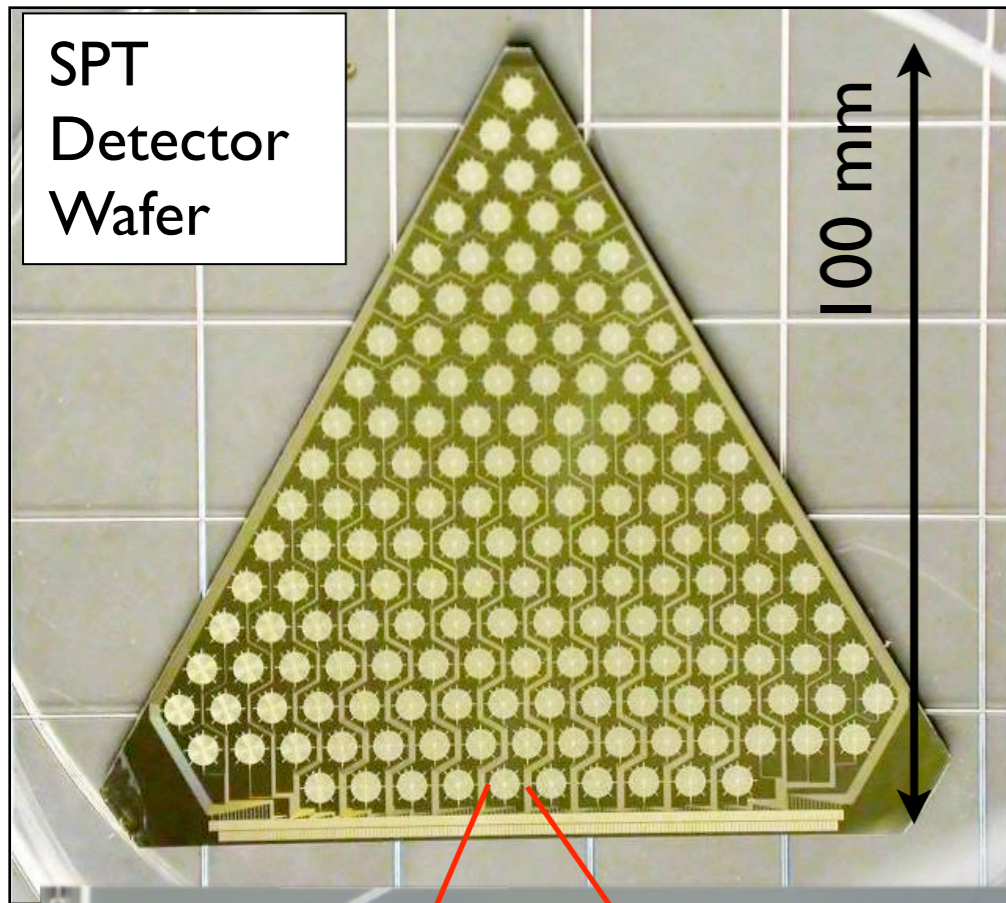

- Fabricated at UC-Berkeley
- 160 bolometers per wafer
- Al-Ti bi-layer (TES) with $T_c = 0.55$ K
- Optical time constant of ~ 10 ms
- Electrical time constant of ~ 1 ms
- Wafer thickness tuned to observing frequency/wavelength

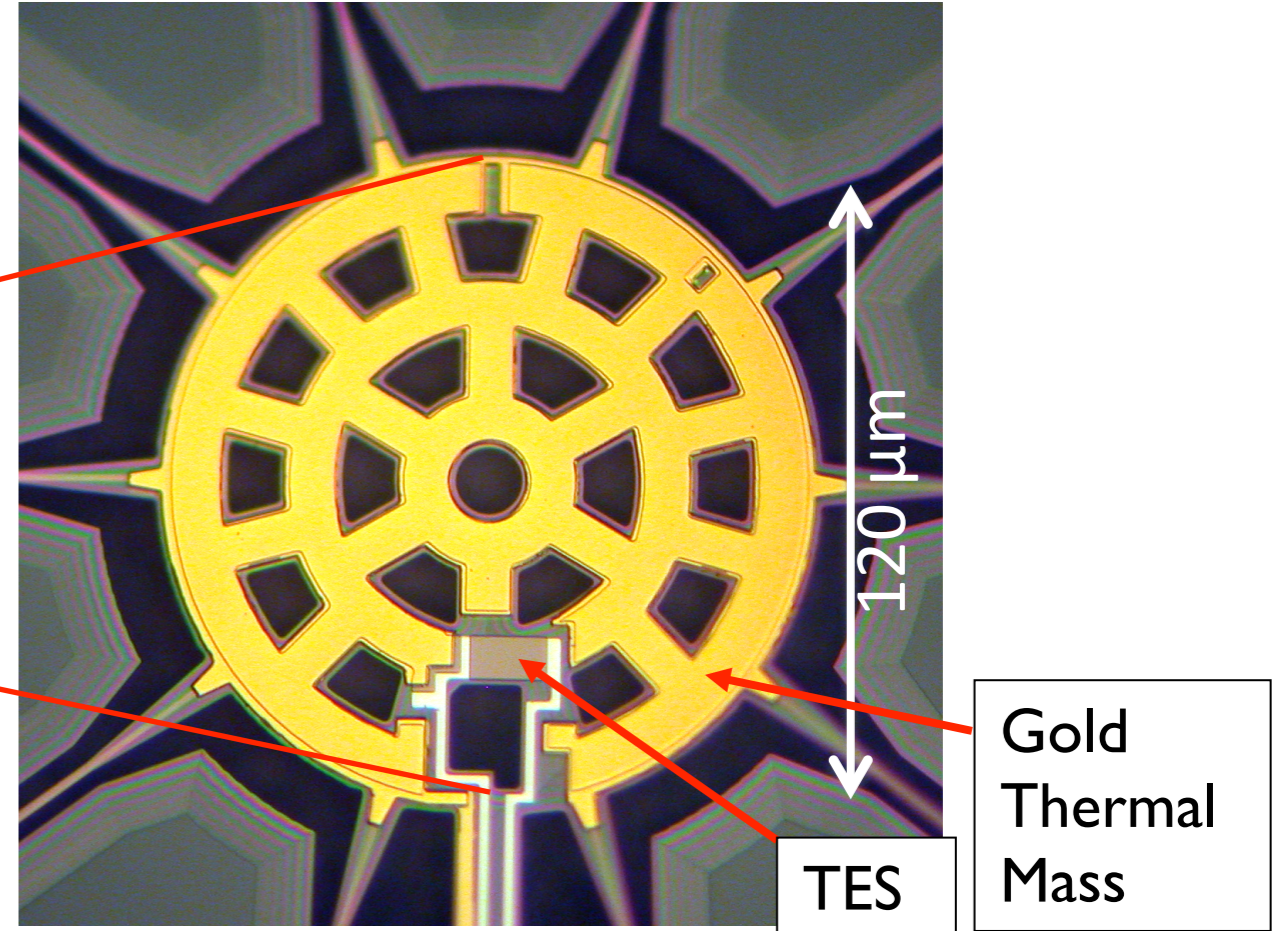
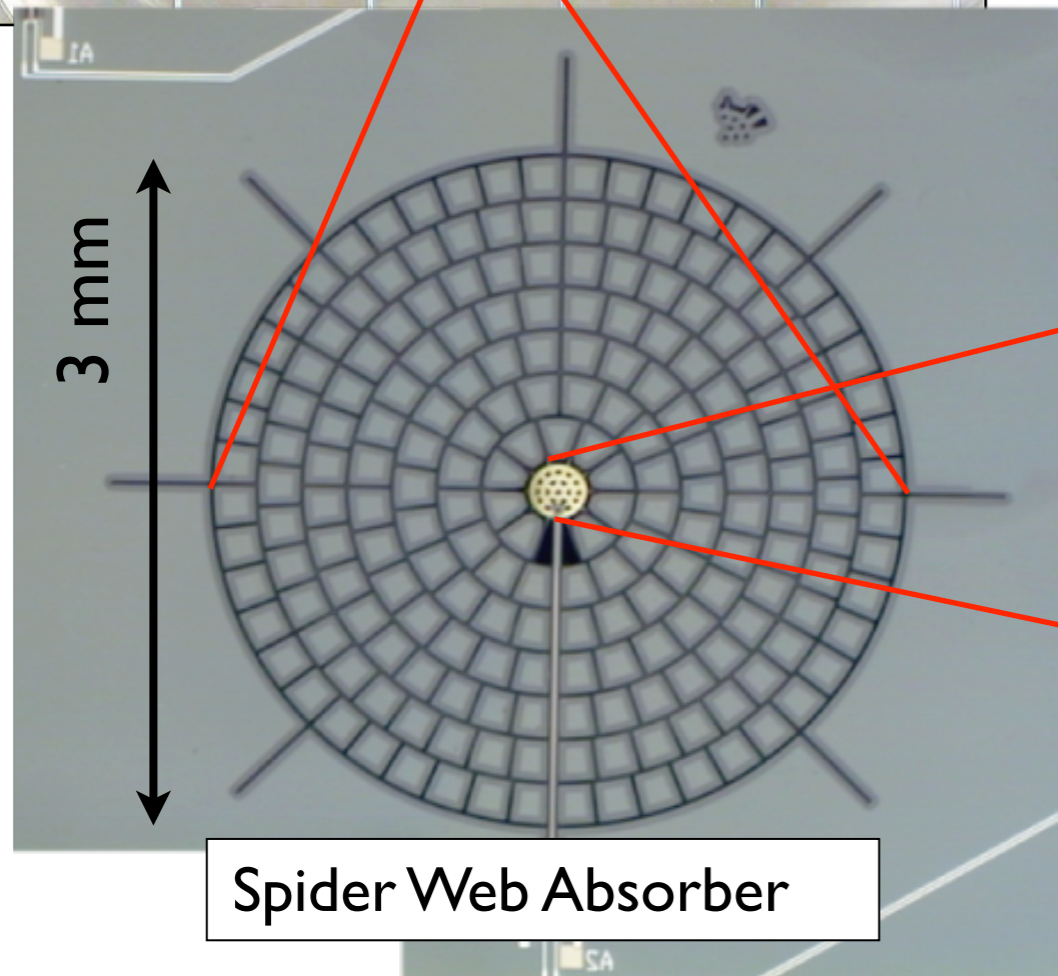

SPT Focal Plane Optics

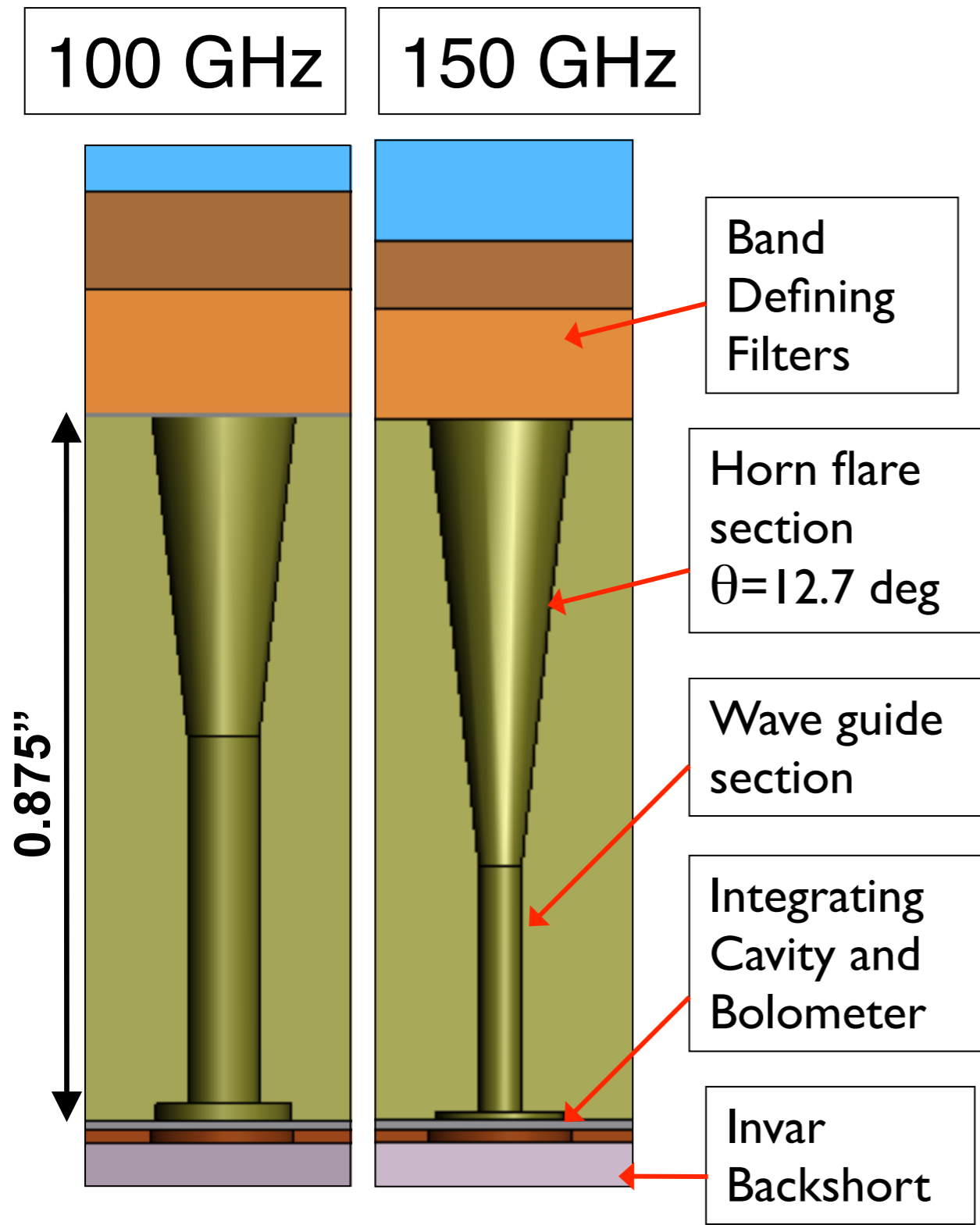

- Light coupled to the detectors thru a conical horn, waveguide, and integrating cavity
- Bands set by waveguide diameter on the low frequency edge and metal-mesh filters on the high-edge

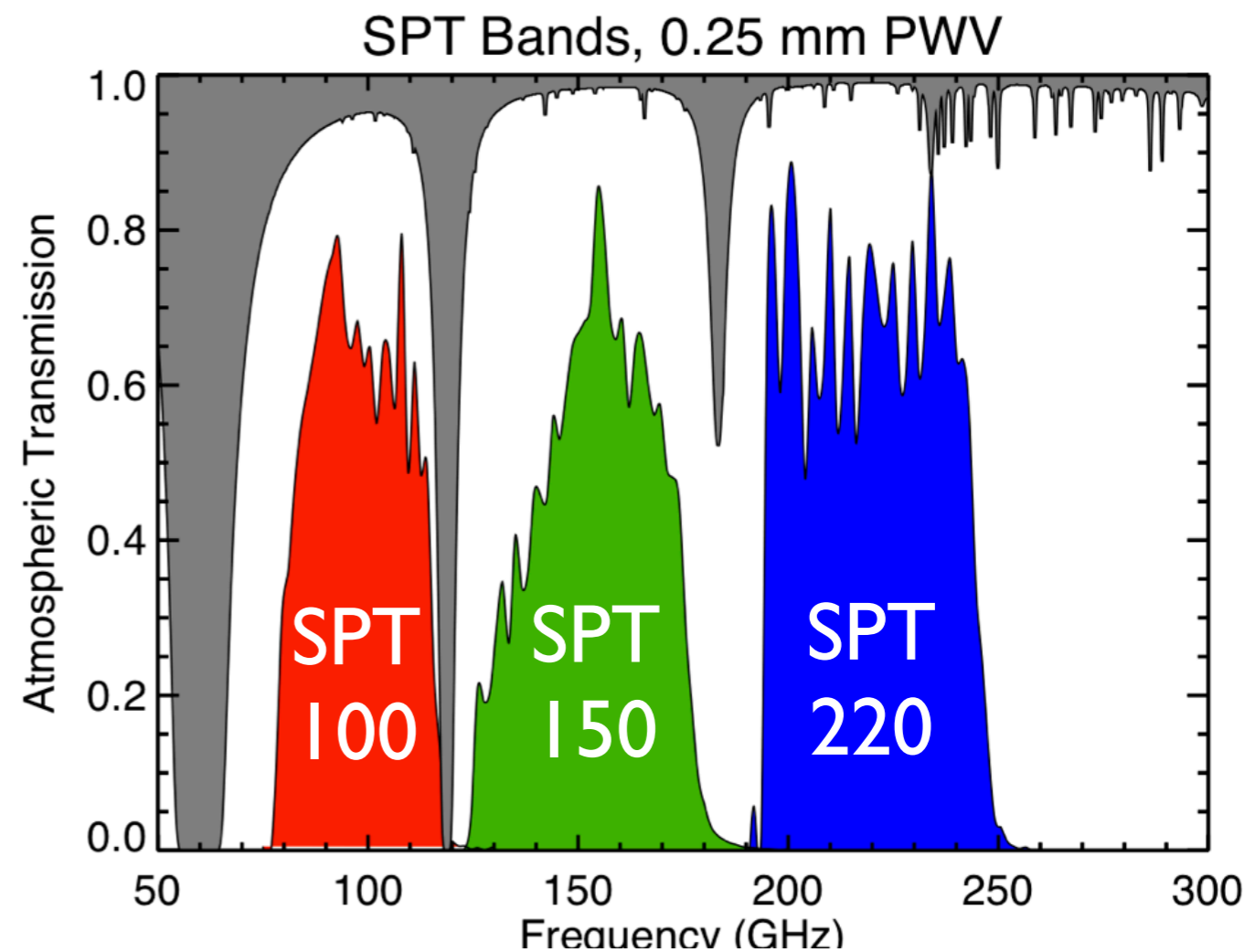

Frequency Domain Multiplexing (fMUX)

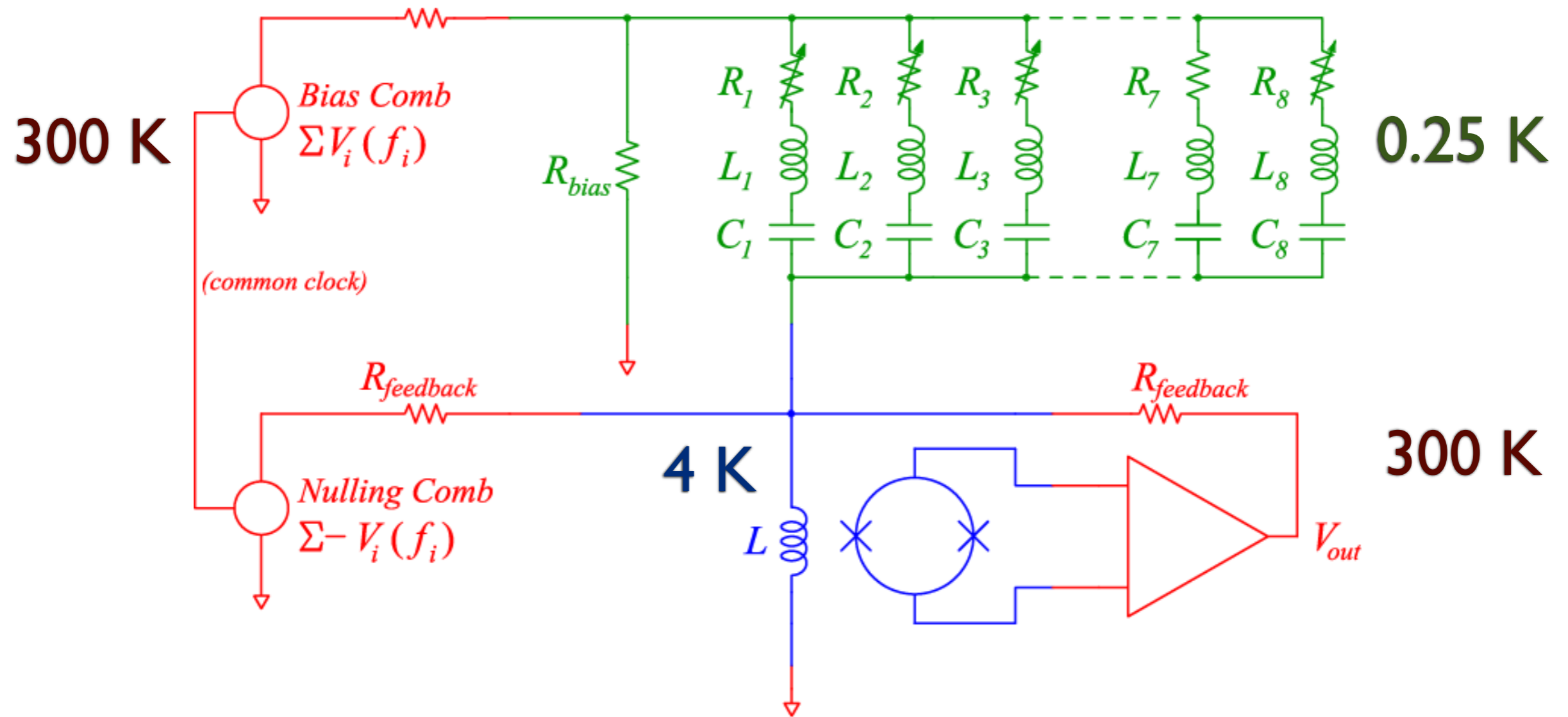

- Developed current summing fMUX at Berkeley and Lawrence Berkeley Labs (LBL)
- AC Bias a row of detectors with comb of frequencies between 300-950 kHz
- Crosstalk determined by Q of LC resonance (designed to be $< 1\%$)
- Null current thru SQUID to improve its dynamic range and linearity

Evolution of Detector Focal Planes

2001: ACBAR
16 detectors

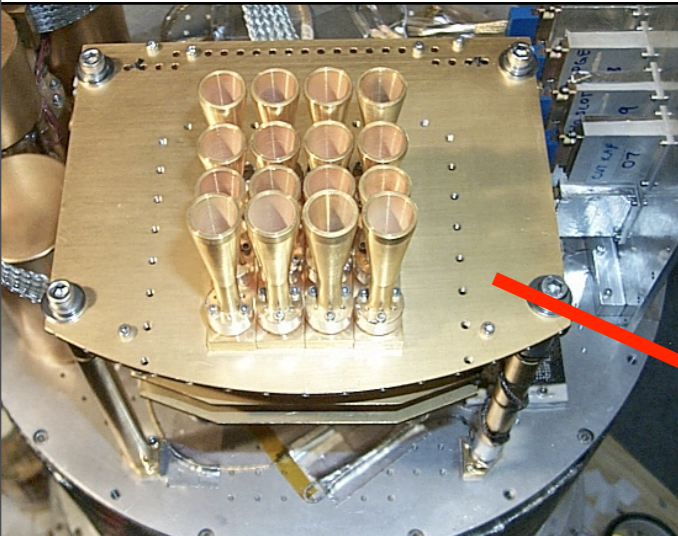

2005: BICEP
~100 detectors

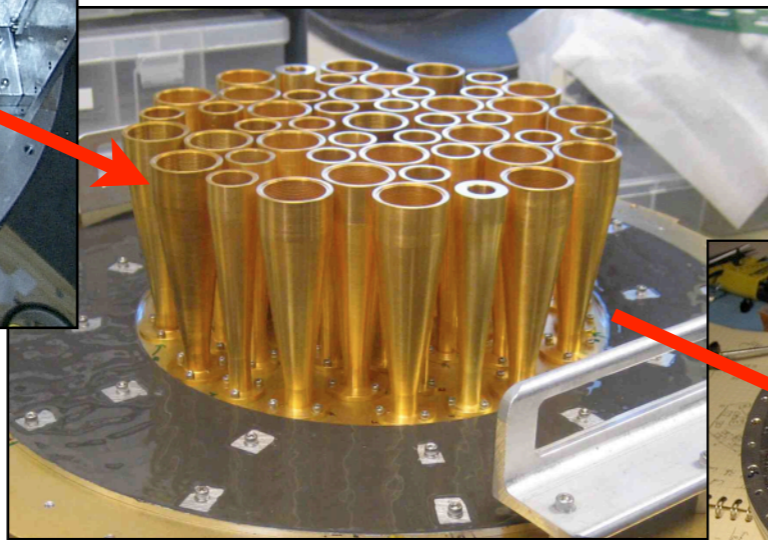

2007: SPT
960 detectors

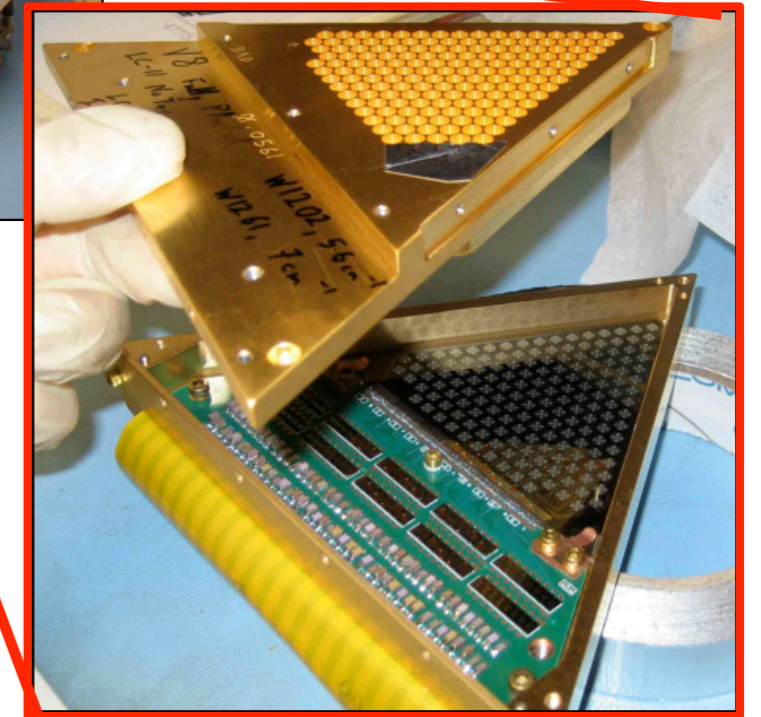
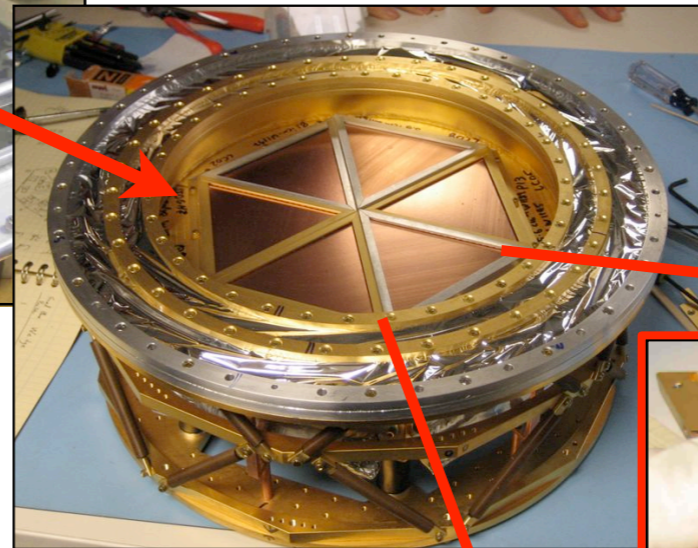

ACBAR was the first experiment to make a “background limited” detector, since then we’ve just been trying to make more of them

Evolution of Detector Focal Planes

2001: ACBAR
16 detectors

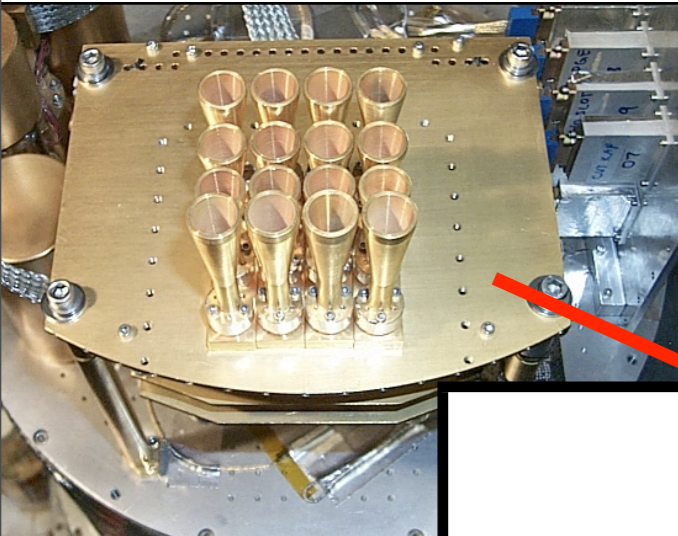

2005: BICEP
~100 detectors

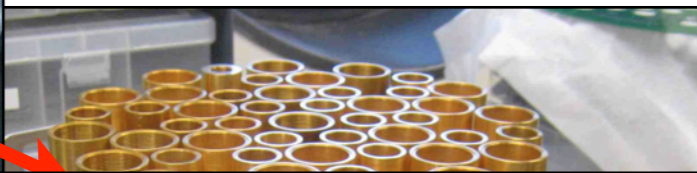

2007: SPT
900 detectors

	NET (noise equivalent temperature) ($\mu\text{K CMB s}^{0.5}$)	SZ Mapping Speed
ACBAR	90	1
BICEP	57	5
ACT	30	9
SPT	18	30
SPTpol	tbd	tbd

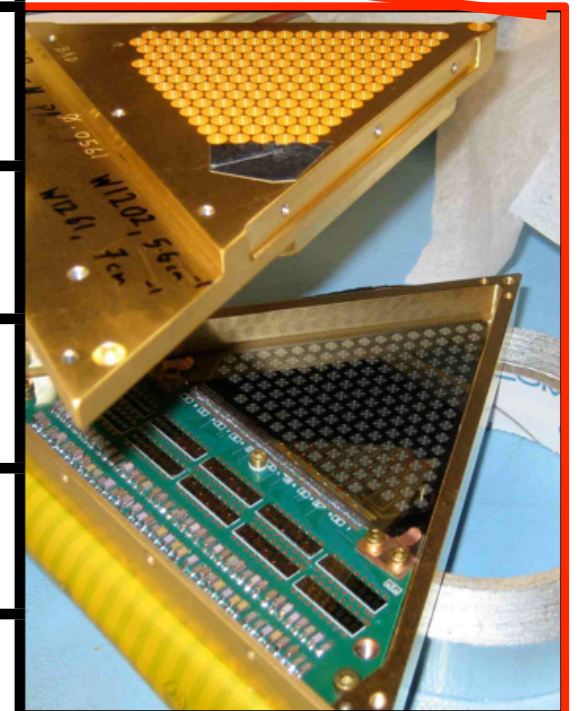

Cosmology from the CMB

1. CMB Anisotropy
2. Clusters
3. CMB Lensing

Cosmology from the CMB

- 1. CMB Anisotropy**
2. Clusters
3. CMB Lensing

Best-fit Λ CDM CMB Model

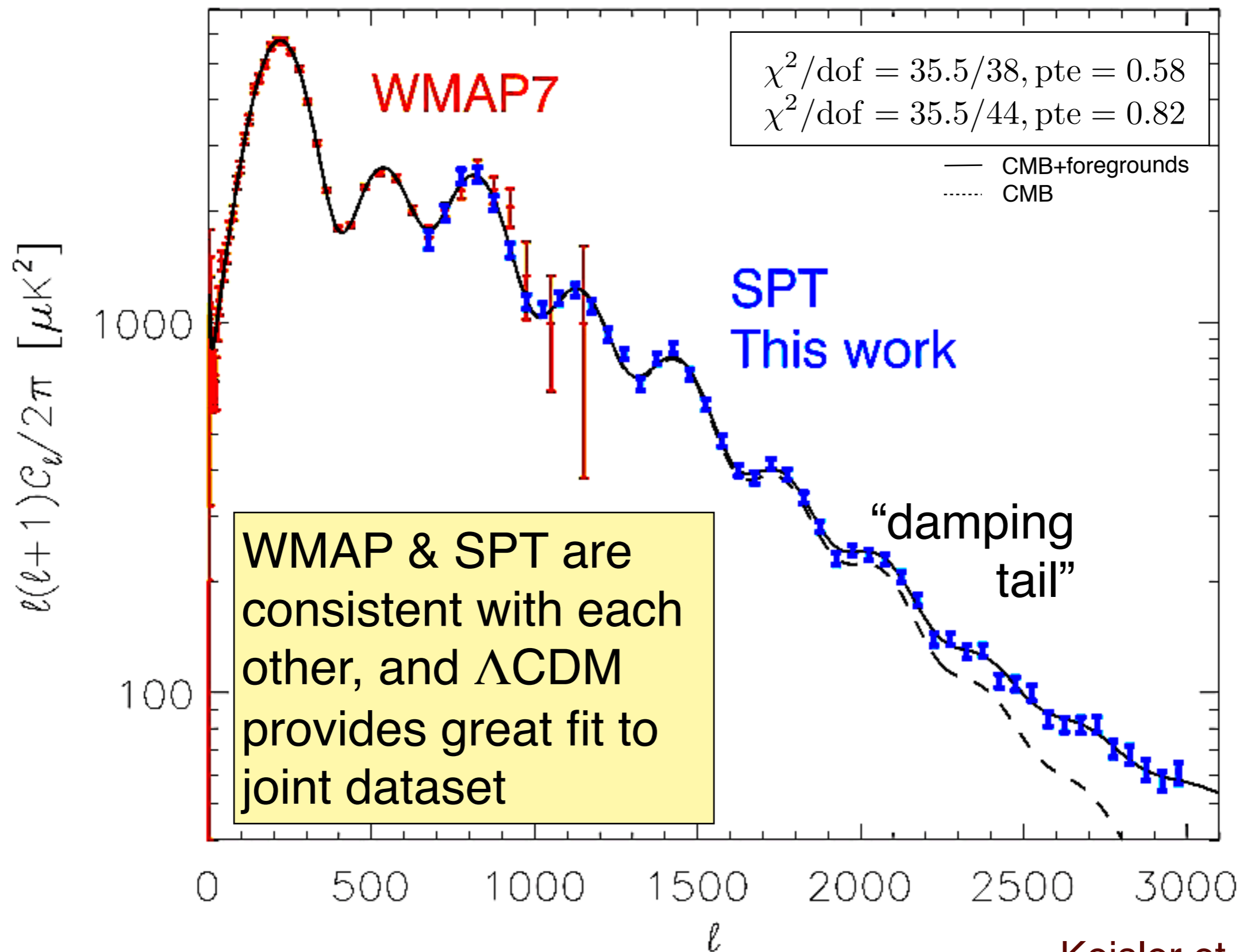

Keisler et al 2011

SPT data provides modest improvement on 6 “vanilla” cosmological parameters

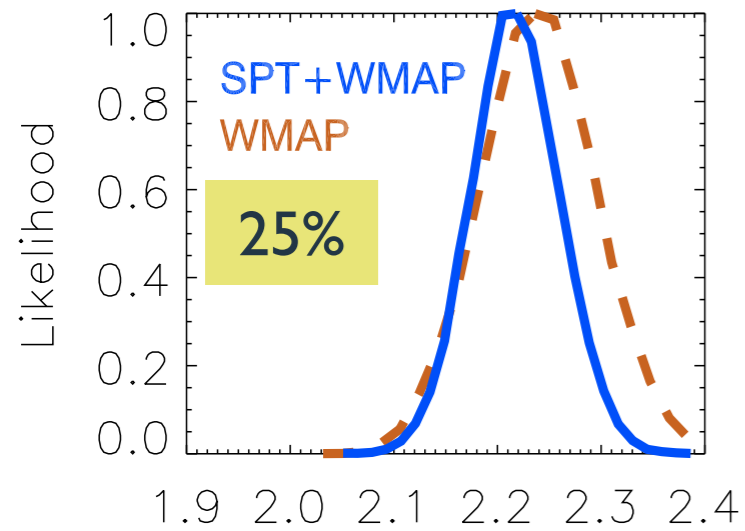

$100 \Omega_b h^2$

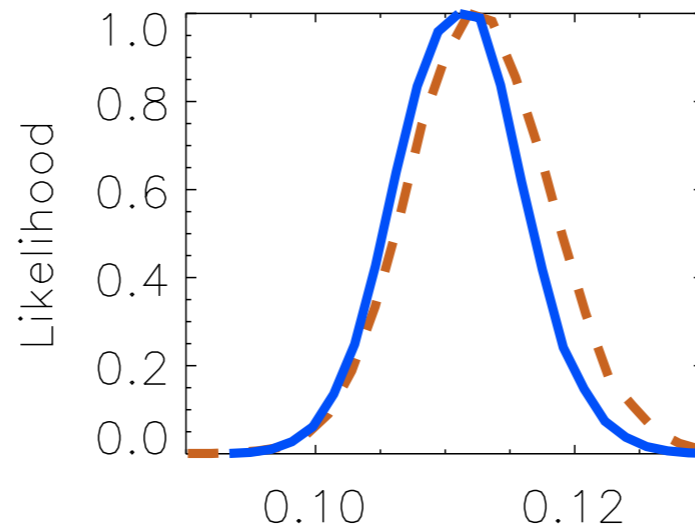

$\Omega_c h^2$

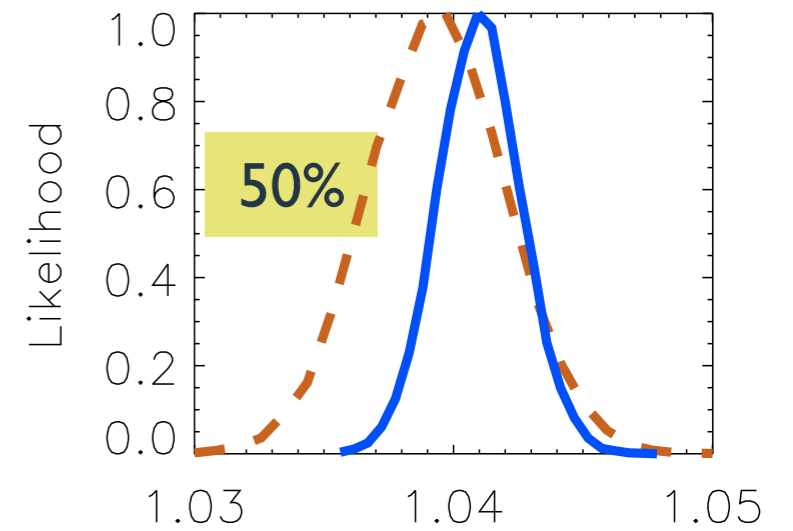

$100 \Theta_s$

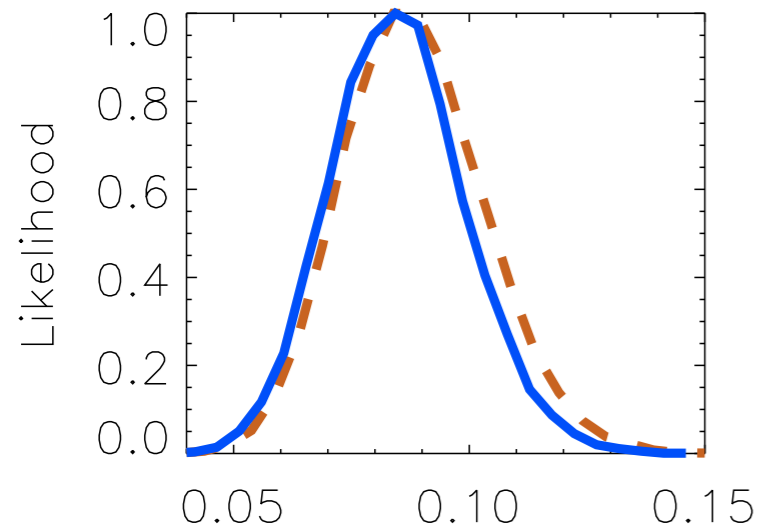

τ

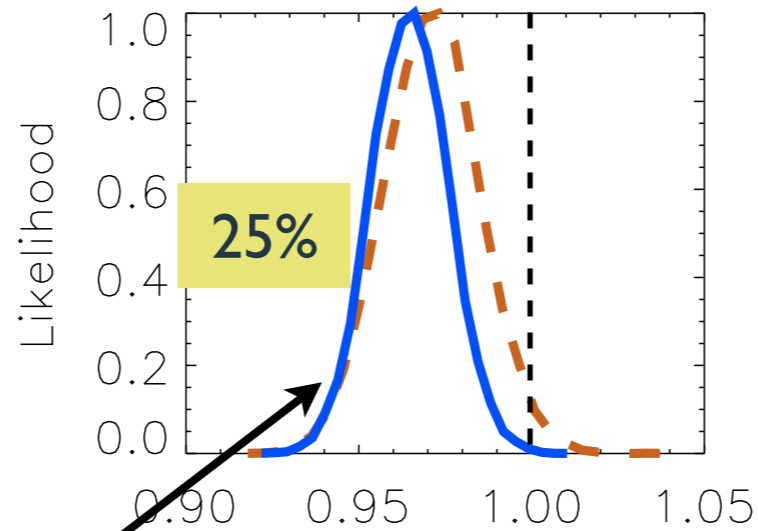

n_s

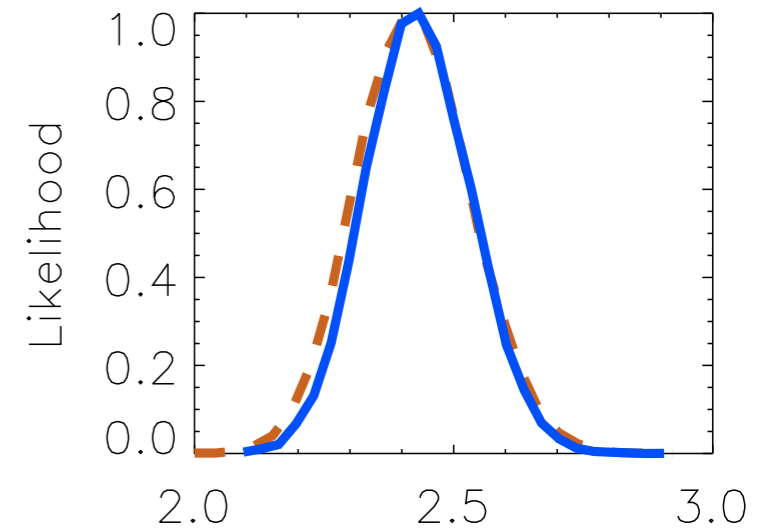

$10^9 \Delta_R^2$

$\Delta_s^2 = A_s k^{n_s-1} : n_s = 0.966 \pm 0.011$ (3.1 σ preference for $n_s < 1$ inflation-like)

Beyond Λ CDM:

The Number of Relativistic Particle Species

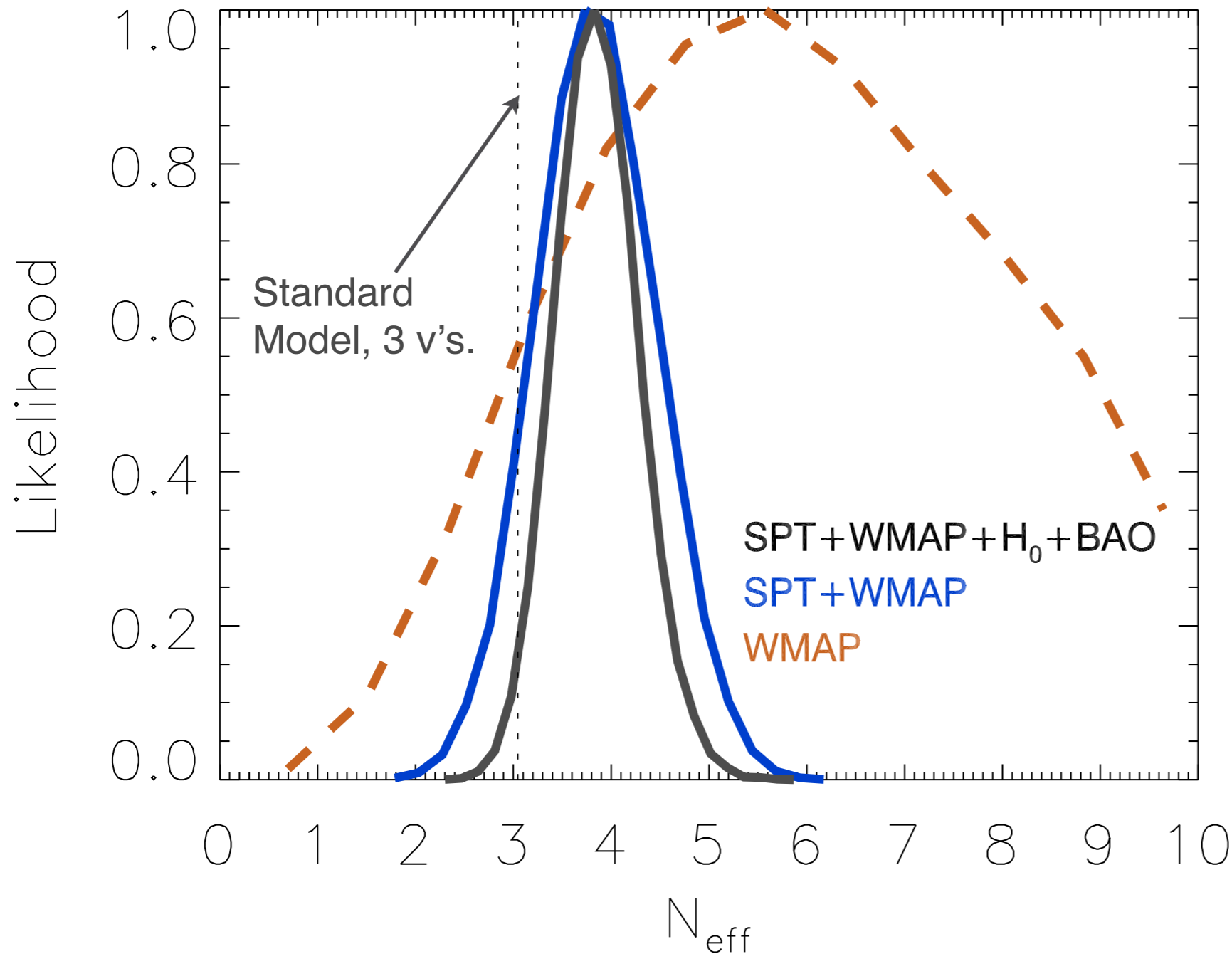

- Normally, we *fix* $N_{\text{eff}} = 3.046$
- Instead, *measure* N_{eff} using CMB.
- No neutrinos rejected at 8σ .
- **$N_{\text{eff}} = 3.86 \pm 0.42$**
(SPT+WMAP+H₀+BAO)
- 2σ higher than standard prediction. (SPT result with 3X more data will help).

Cosmology from the CMB

1. CMB Anisotropy
- 2. Clusters**
3. CMB Lensing

Clusters of Galaxies

Hubble Image of
A1689

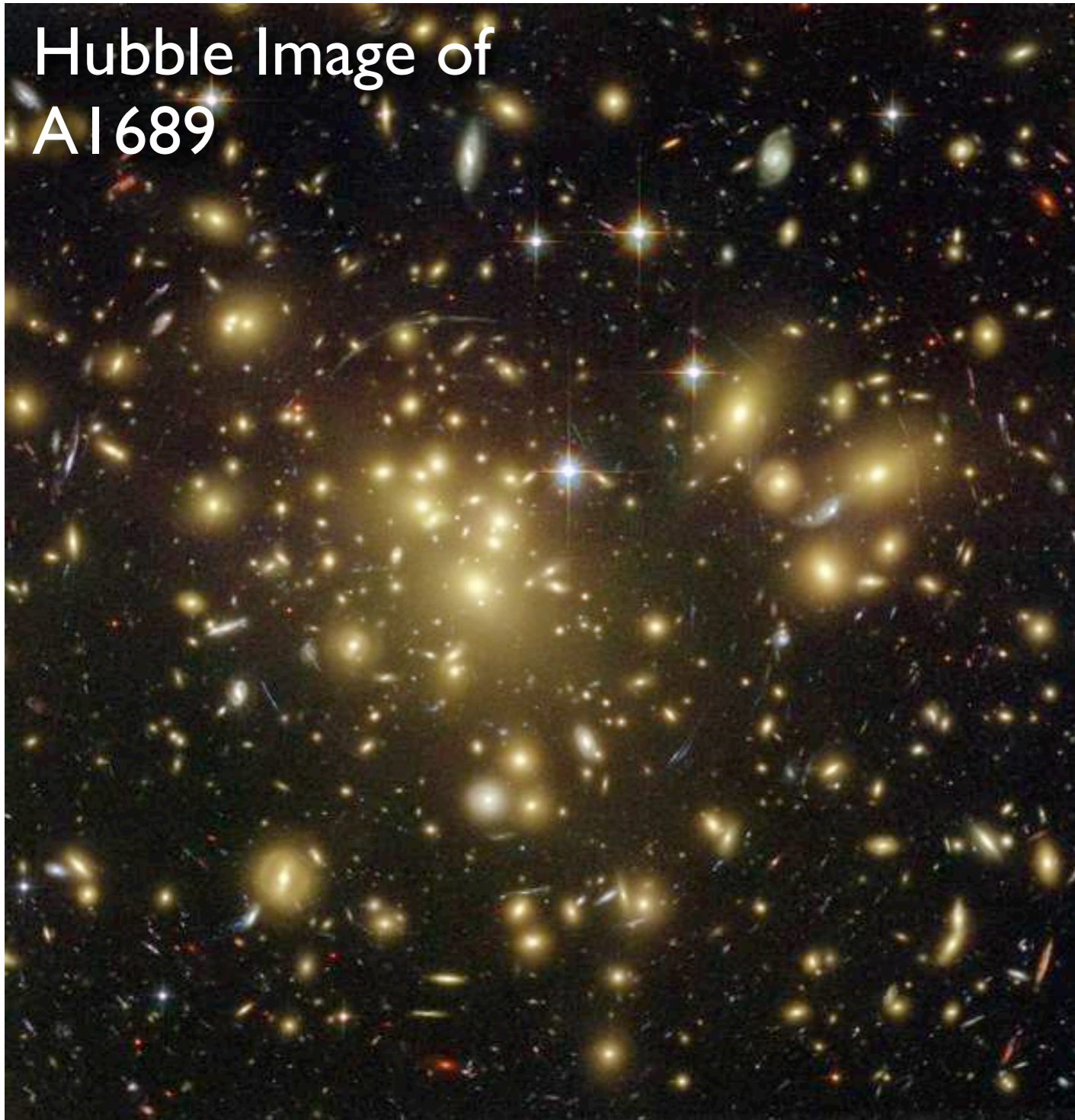

- They are the most massive objects in the Universe (and also the most rare)
- The biggest clusters contain thousands of galaxies
- Take billions of years to form
- One of the few tracers of structure big enough to “feel” dark energy

Baryons Are Mostly in the Form of Hot Gas

A Massive Cluster collects a lot of gas, and as this gas collapses in the cluster it heats up to $\sim 100,000,000$ degrees

(Purple -
Chandra X-ray
image overlaid)

The Sunyaev Zel'dovich (SZ) Effect

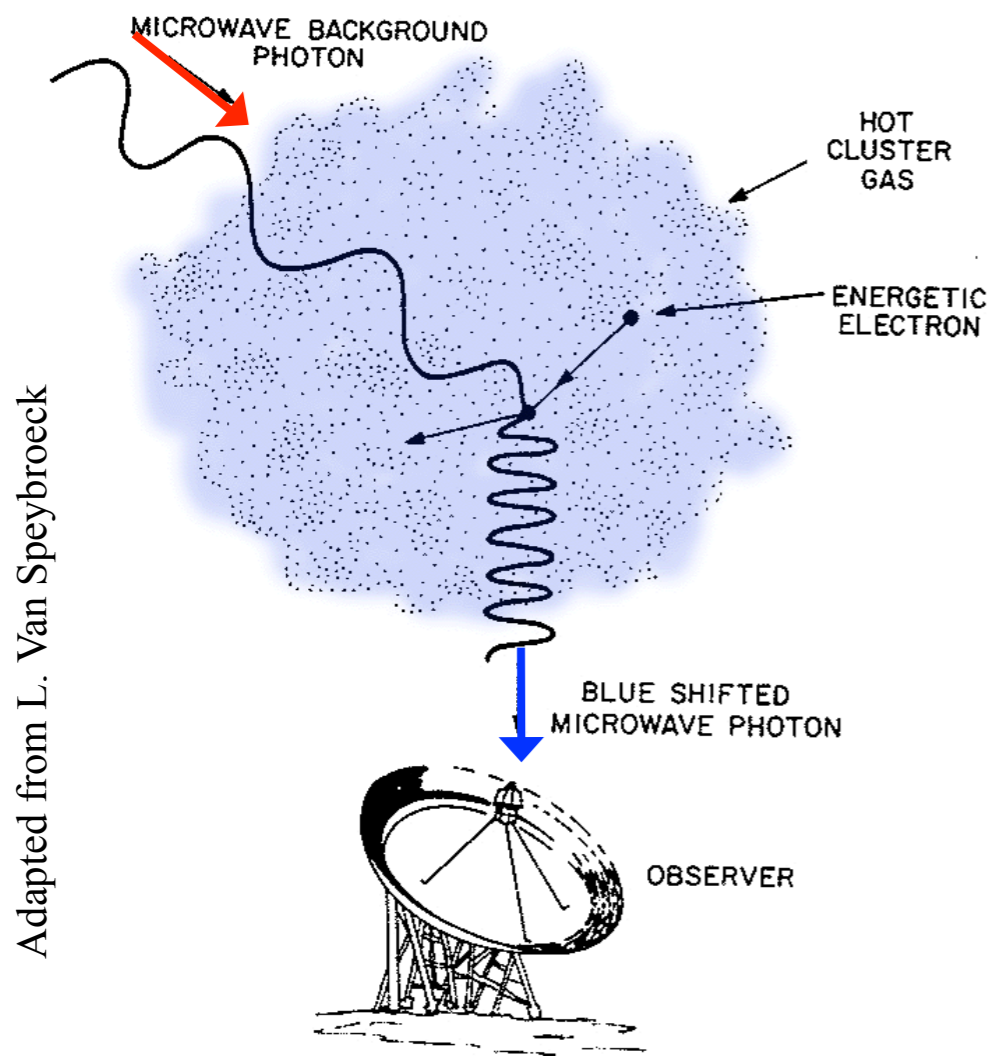

- Towards a massive cluster, $\sim 1\%$ of CMB photons scatter off of intra-cluster gas
- SZ Surface Brightness is redshift independent

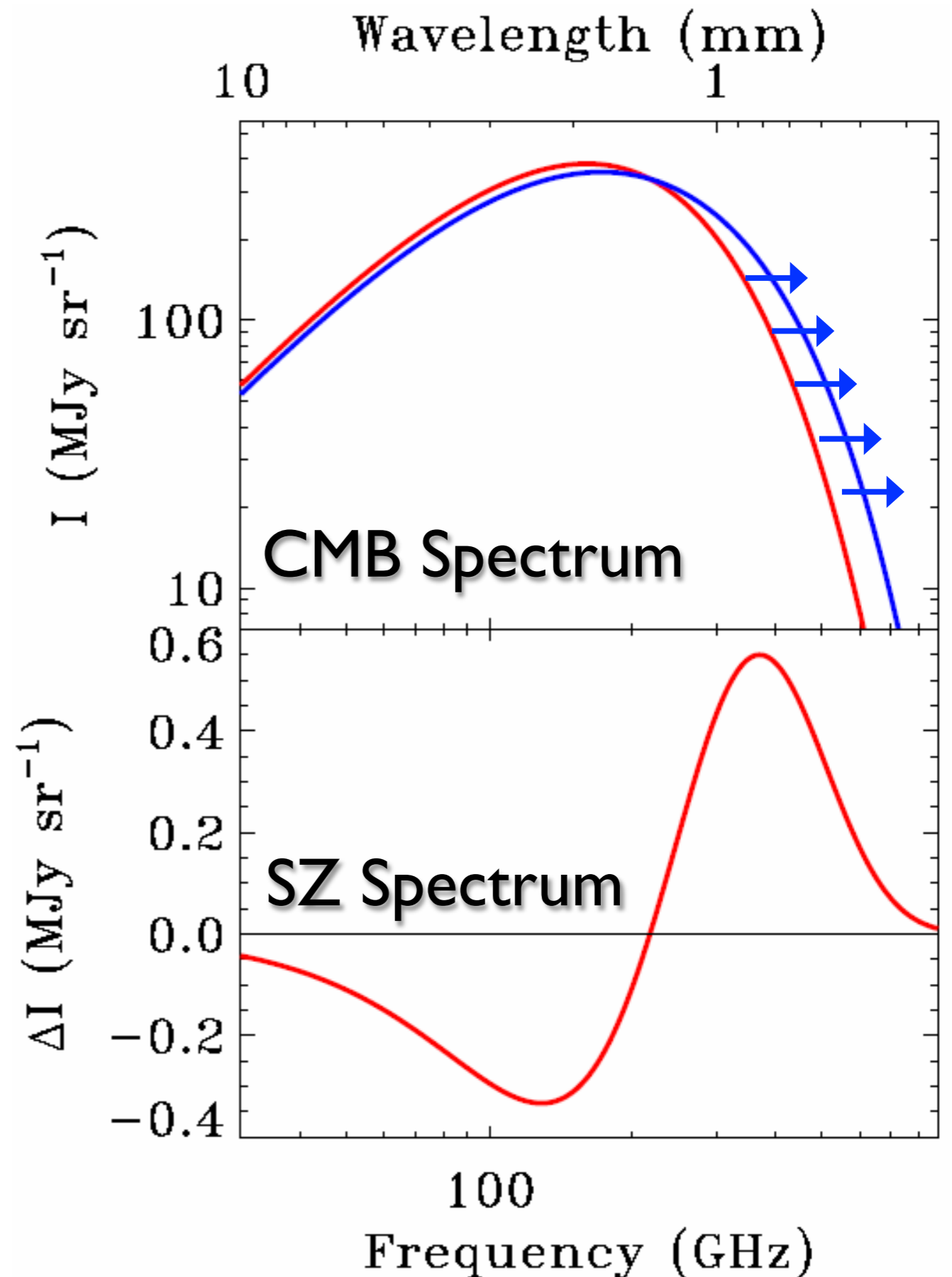

Dark Energy and Cluster Cosmology

- Abundance of clusters is sensitive to the **dark energy equation of state**, $w = p / \rho$
- If dark energy was due to a cosmological constant then $w = -1$

Cluster Abundance: dN/dz

$$\frac{dN}{d\Omega dz} = n(z) \frac{dV}{d\Omega dz}$$

Depends on:

Matter Power Spectrum, σ_8

Growth Rate of Structure, $D(z)$

Depends on:

Rate of Expansion, $H(z)$

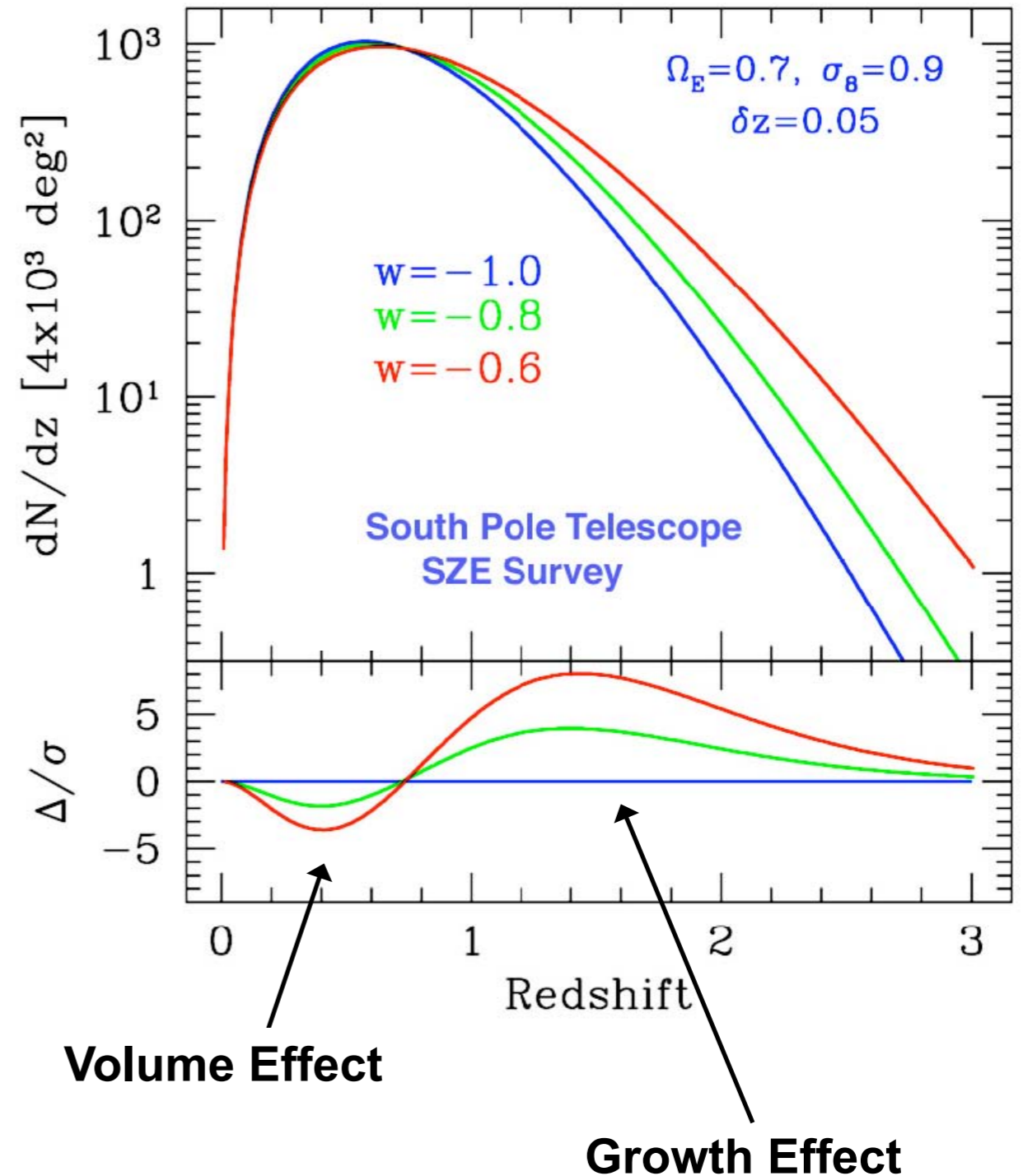

Dark Energy: Distance vs Growth

Distance-Redshift Relation:

- $d_L(z)$ = Luminosity Distance
(e.g., Supernovae, ...)

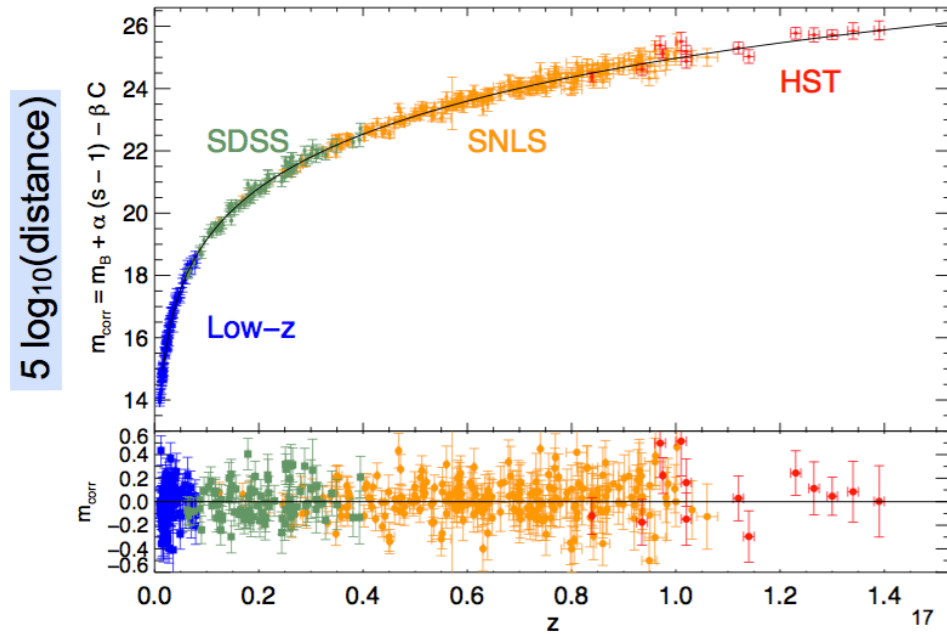

- $d_A(z)$ = Angular Diameter Distance
(e.g., Baryon Acoustic Oscillations, ...)

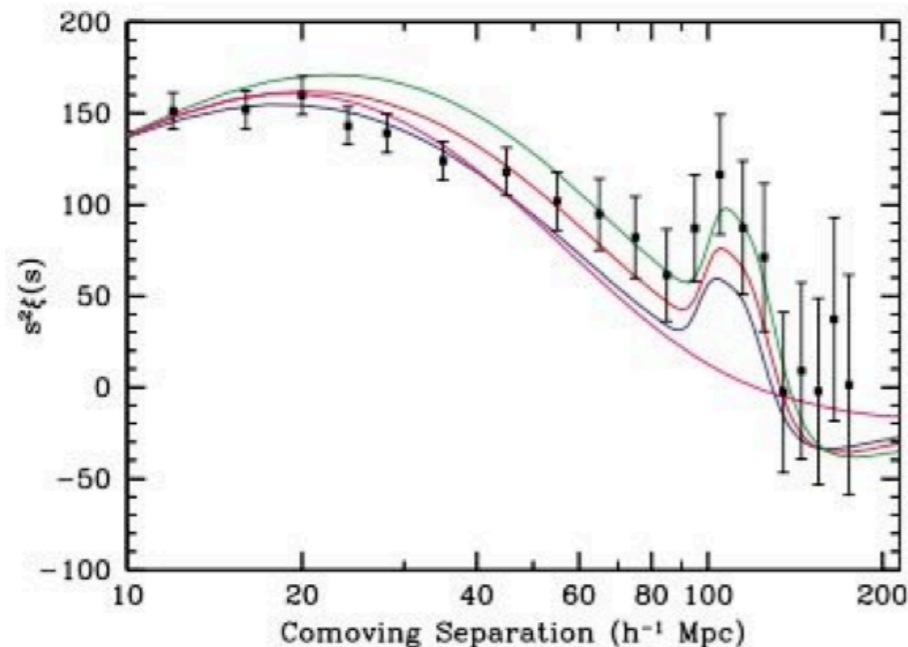

Growth of Structure:

- $D(z)$ = Growth factor - $\delta(z)/\delta_0$
(e.g., Clusters of Galaxies, CMB Lensing, Weak Lensing, ...)

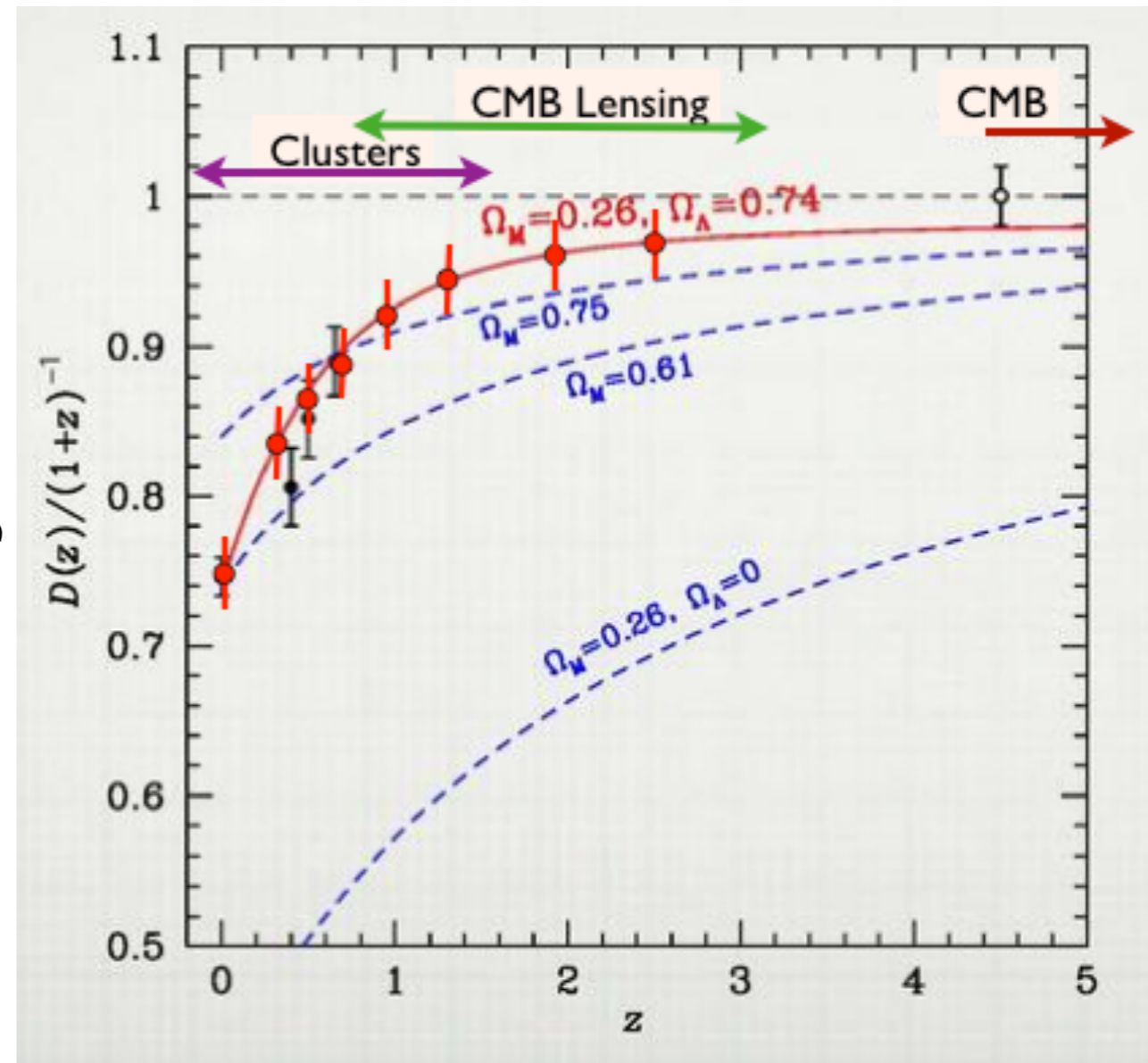

Dark Energy: Distance vs Growth

Distance-Redshift Relation:

- $d_L(z)$ = Luminosity Distance
(e.g., Supernovae, ...)

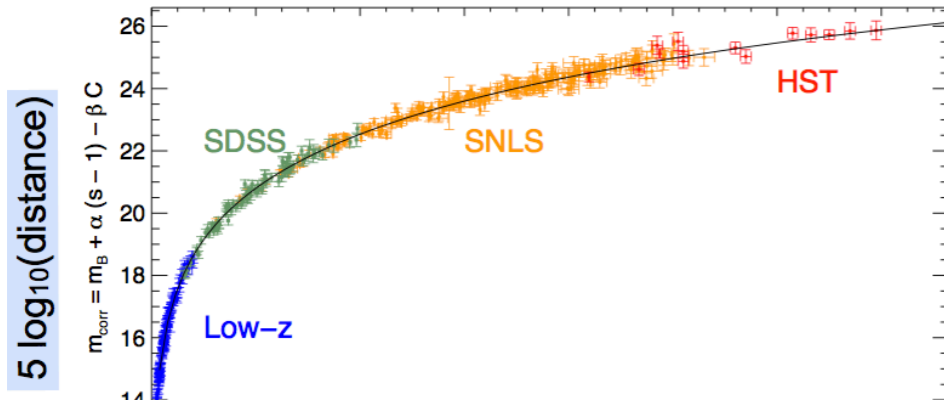

Growth of Structure:

- $D(z)$ = Growth factor - $\delta(z)/\delta_0$
(e.g., Clusters of Galaxies, CMB Lensing, Weak Lensing, ...)

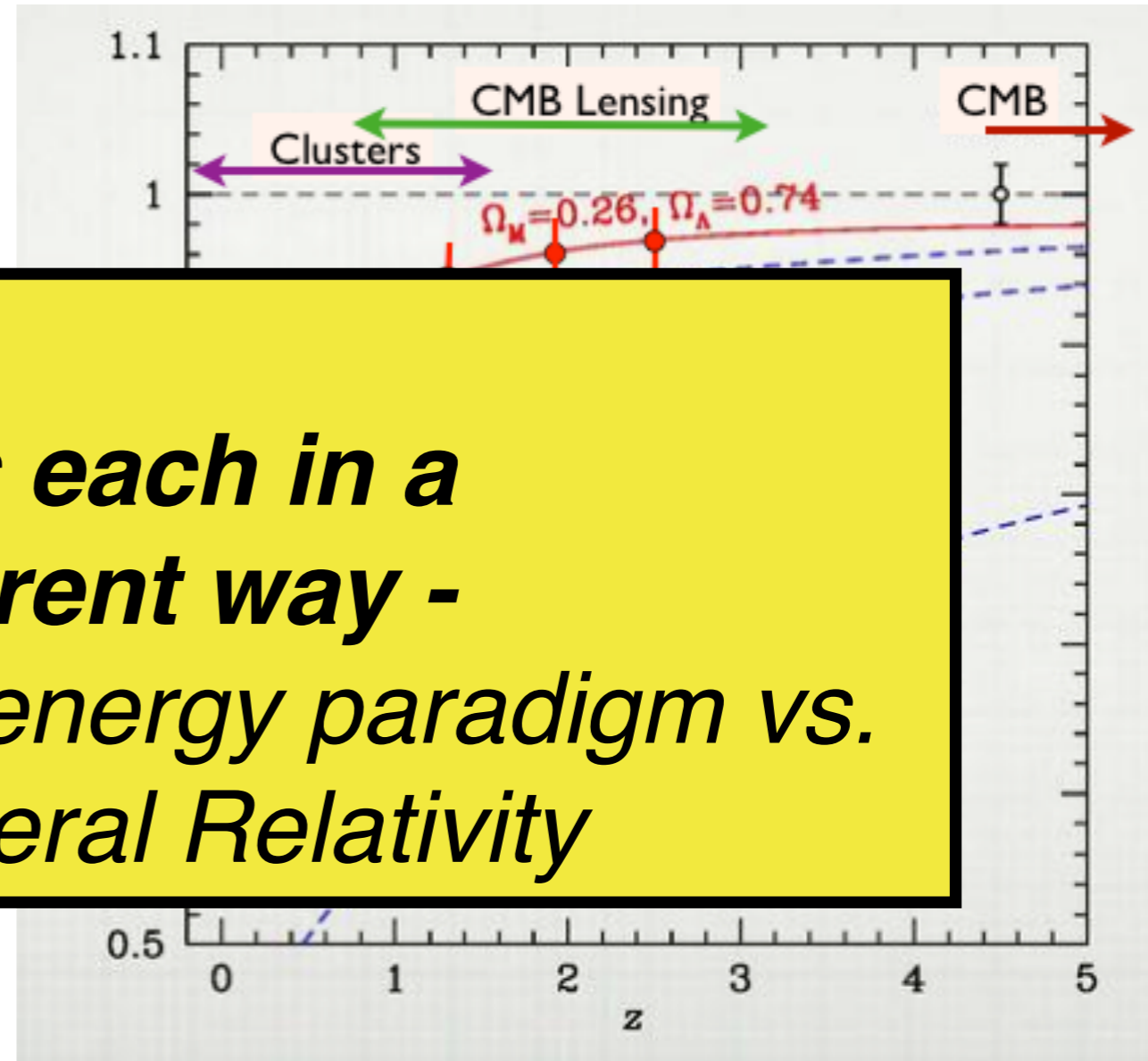

Distance vs Growth:

Dark energy affects each in a fundamentally different way -

Tests standard dark energy paradigm vs. modifications of General Relativity

- d_A
(e.g., ...)

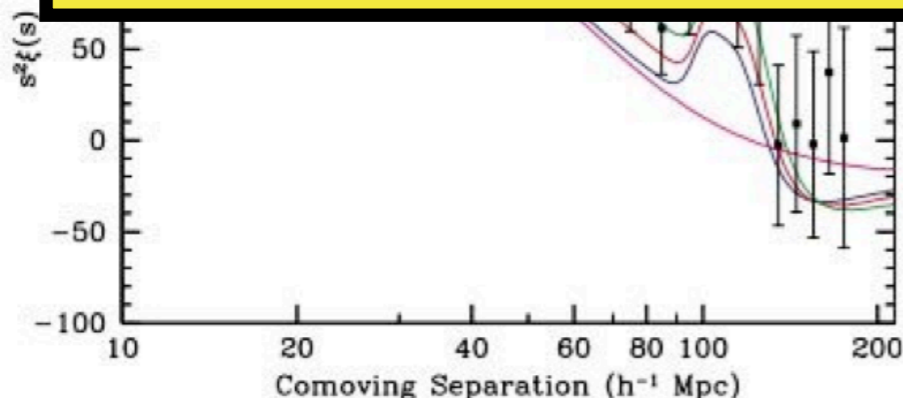

SPT Discovered Clusters from first 750 deg²

SNR=22

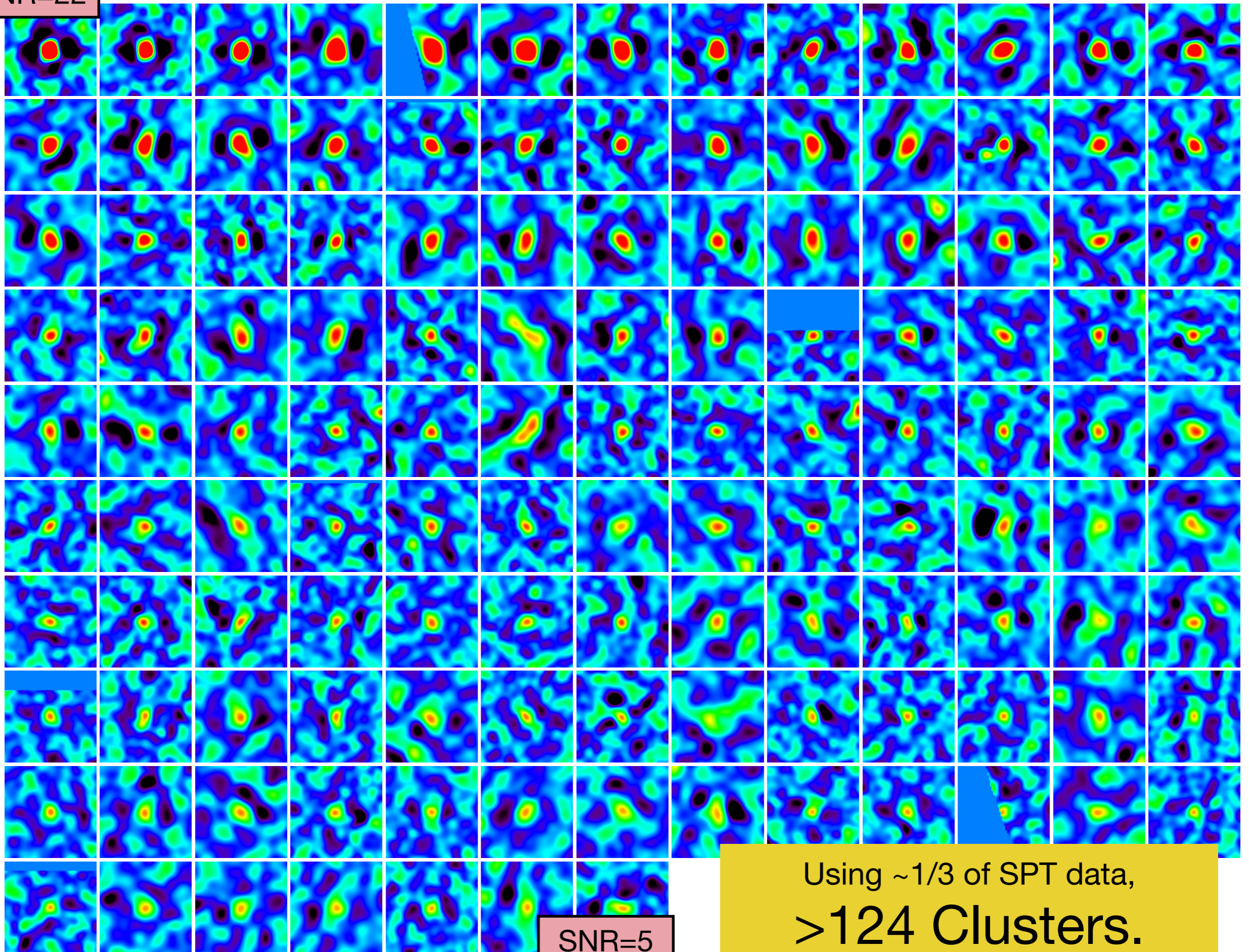

SNR=5

Using ~1/3 of SPT data,
>124 Clusters.

Some Massive SPT Clusters

0658-5358 ($z=0.30$)
(Bullet)

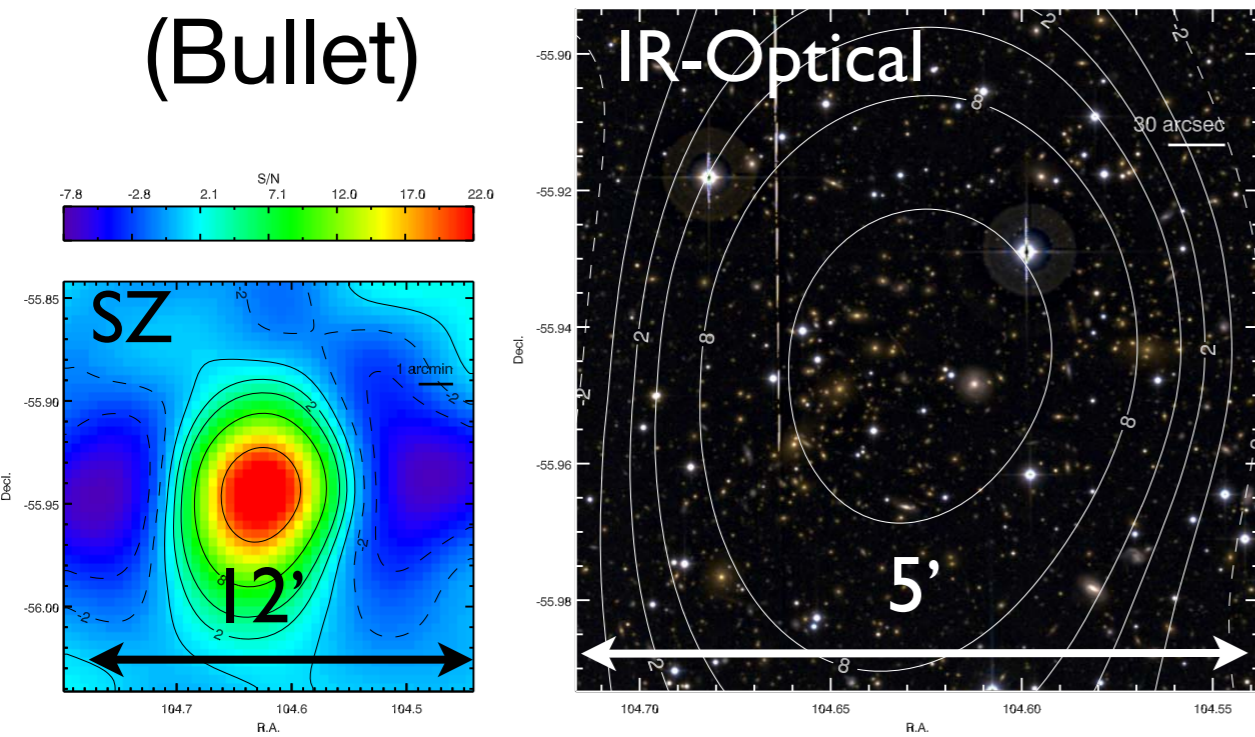

2344-4243 ($z=0.62$)
(Perseus-like cooling core at $z > 0.6$)

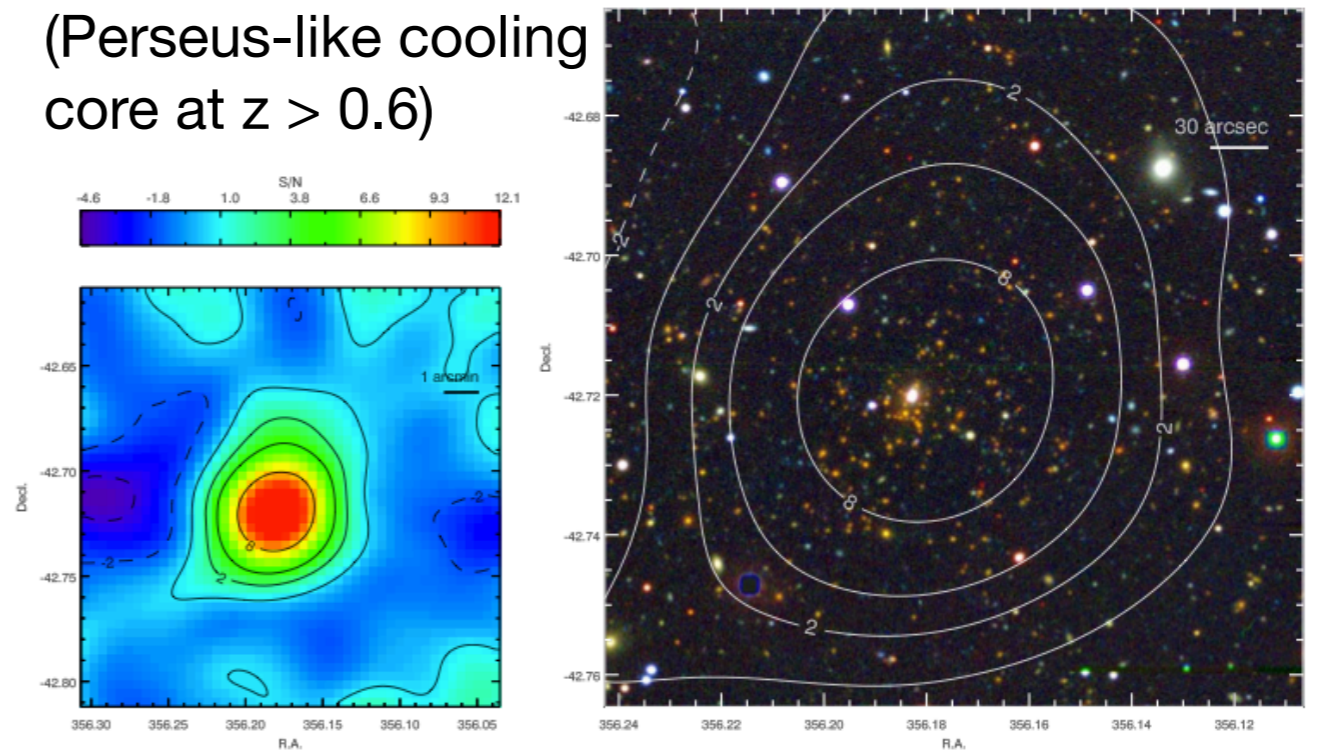

2337-5942 ($z=0.78$)

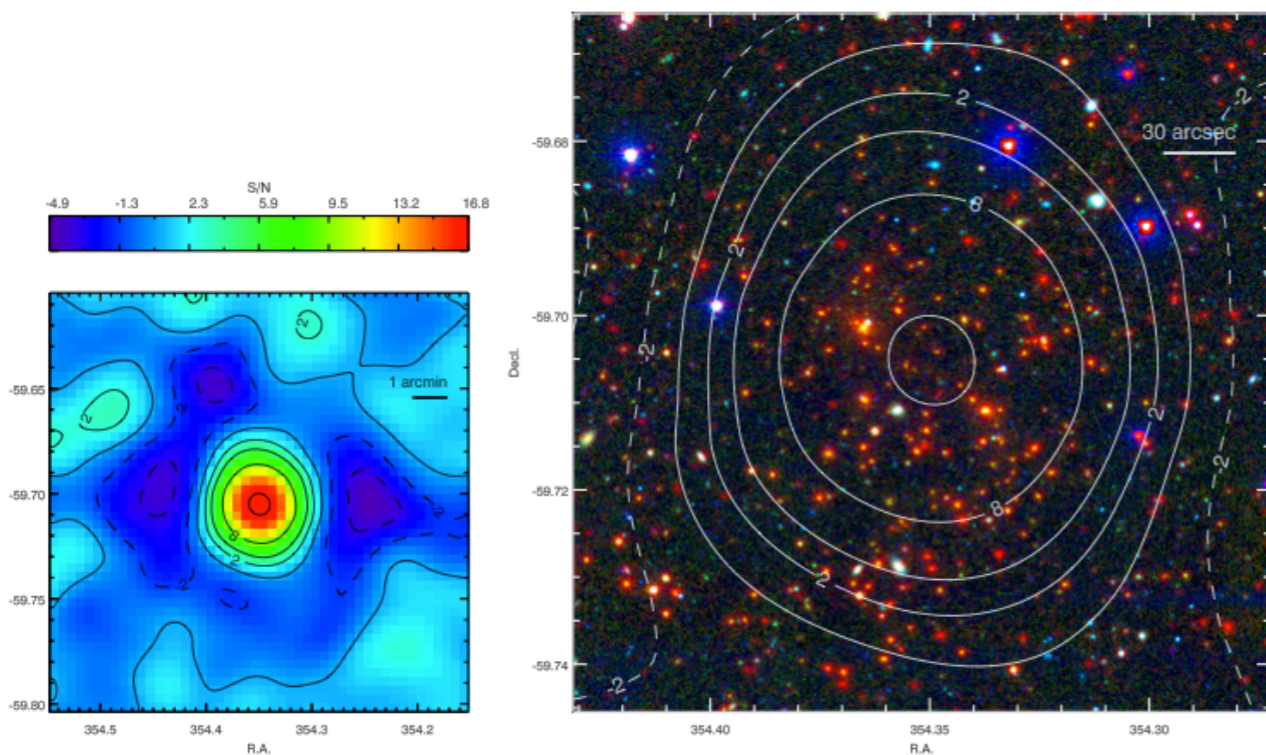

2106-5844 ($z=1.13$)
(the most massive cluster at $z > 1$)

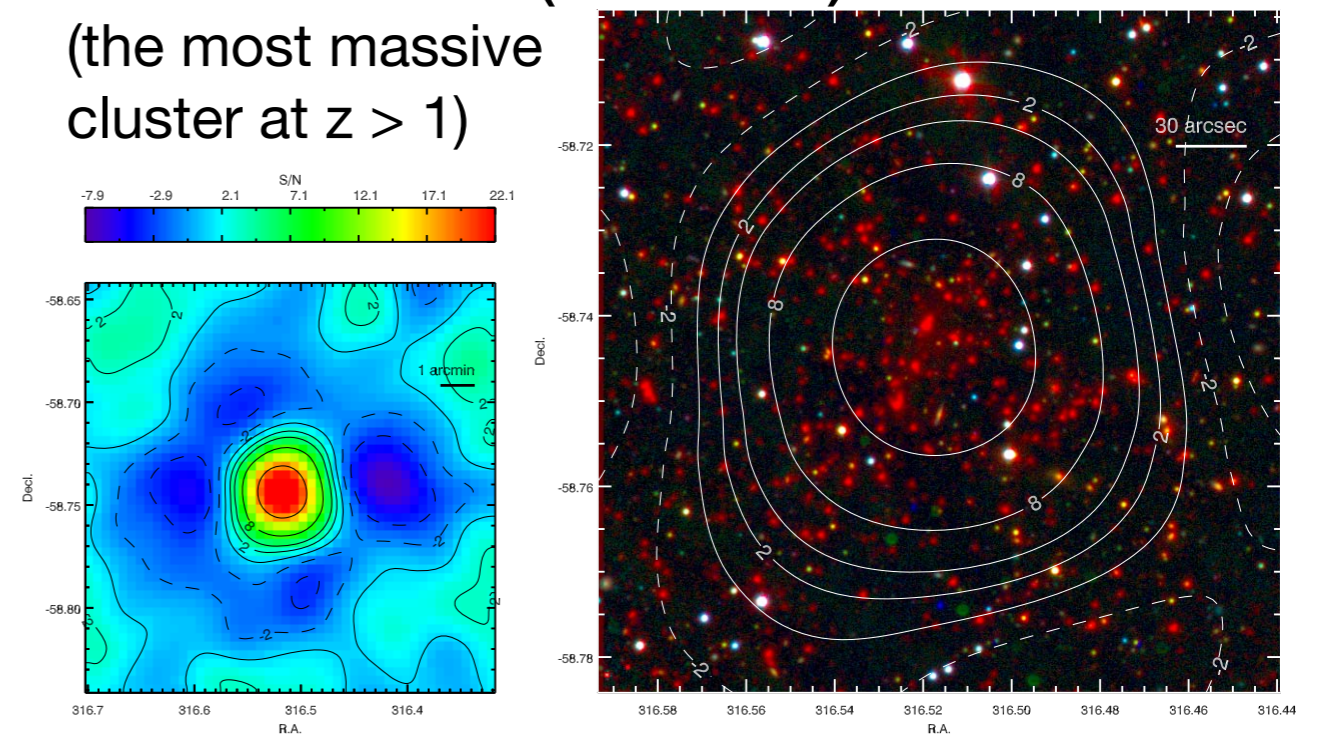

SPT Cluster Sample Properties

Cluster Mass vs Redshift

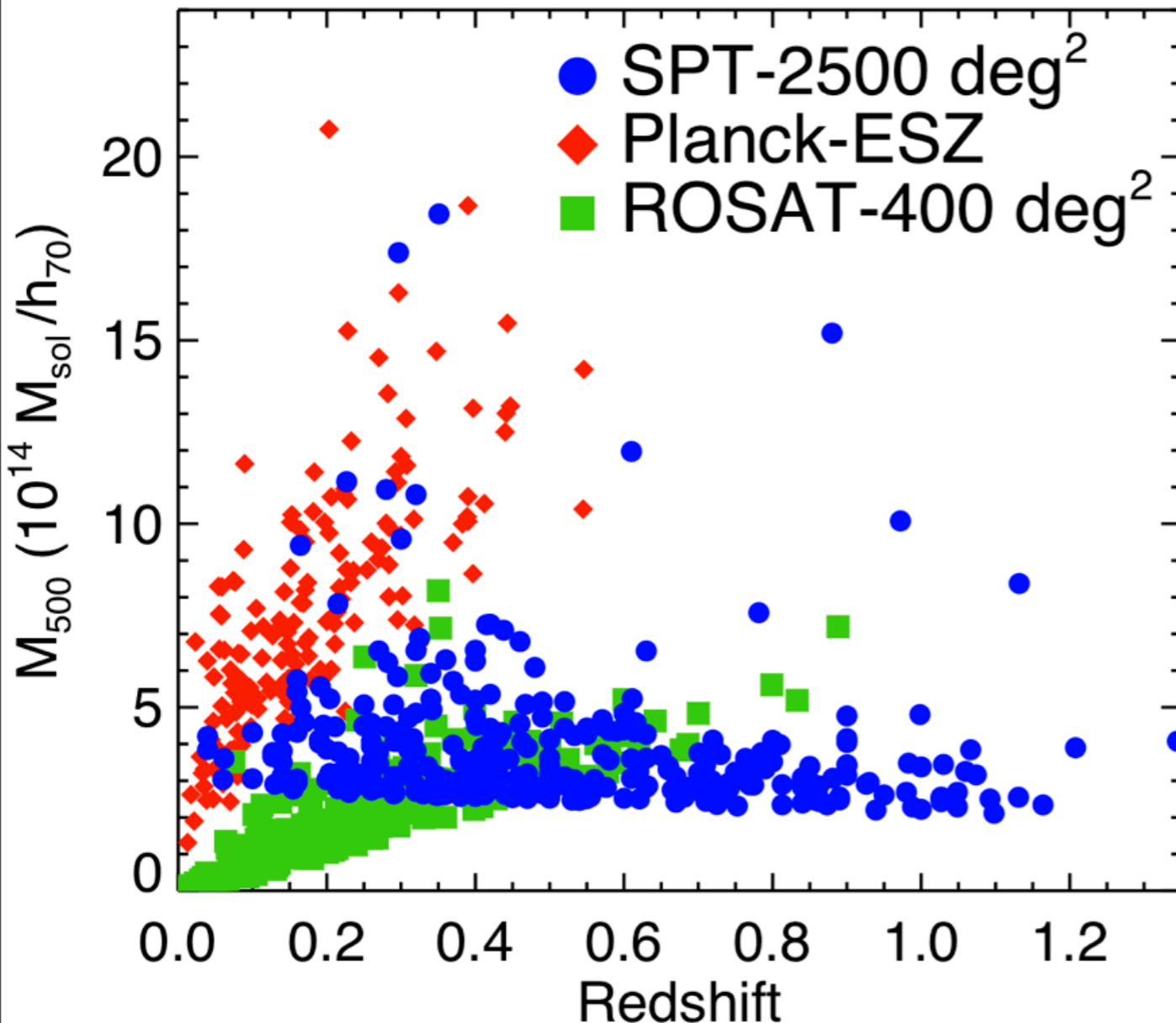

- Over 325 clusters optically confirmed, $\sim 80\%$ new discoveries
- Expect ~ 500 clusters in full catalog
- High redshift: $\langle z \rangle \sim 0.55$ (20% of clusters at $z > 0.8$)
 - **SPT has found more massive clusters at $z > 0.4$ than previously known!**
- Mass threshold falls with redshift:
 - $M_{500}(z=0.6) > 3 \times 10^{14} M_{\text{sol}}/h_{70}$

SPT Significance as a Mass Proxy

From Simulations by Laurie Shaw

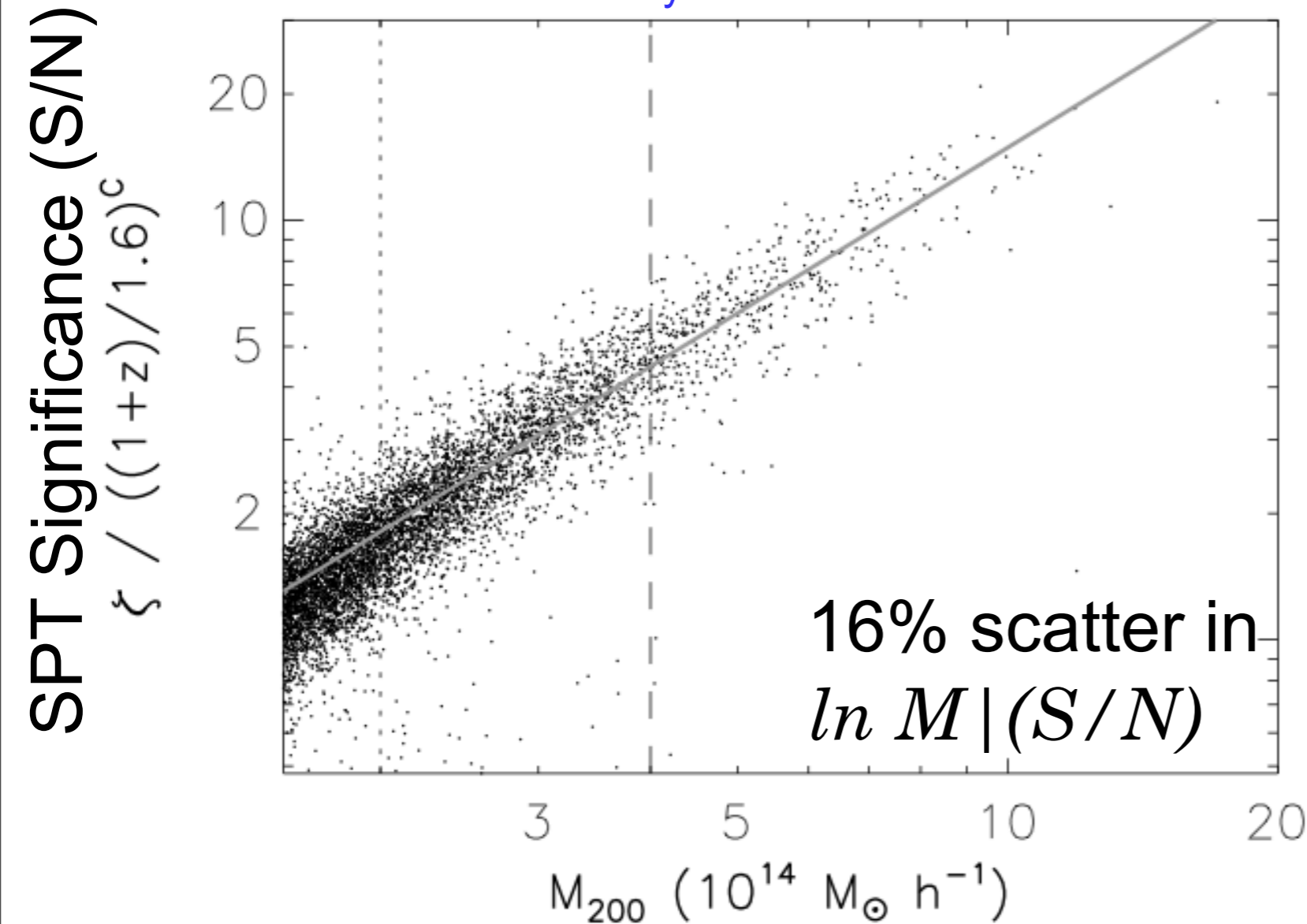

- For any cluster survey, challenge is to link cluster “observable” to cluster mass
- SZ measures cluster pressure ($\sim n_e T_e$), which is expected to have low scatter with mass ($\sim 10\%$)
- SZ Signal-to-noise (S/N) in spatial filtered map is a relatively good mass proxy (Vanderlinde et al 2010)
- **Need to calibrate SZ significance to cluster mass!**

SPT Significance as a Mass Proxy

From Simulations by Laurie Shaw

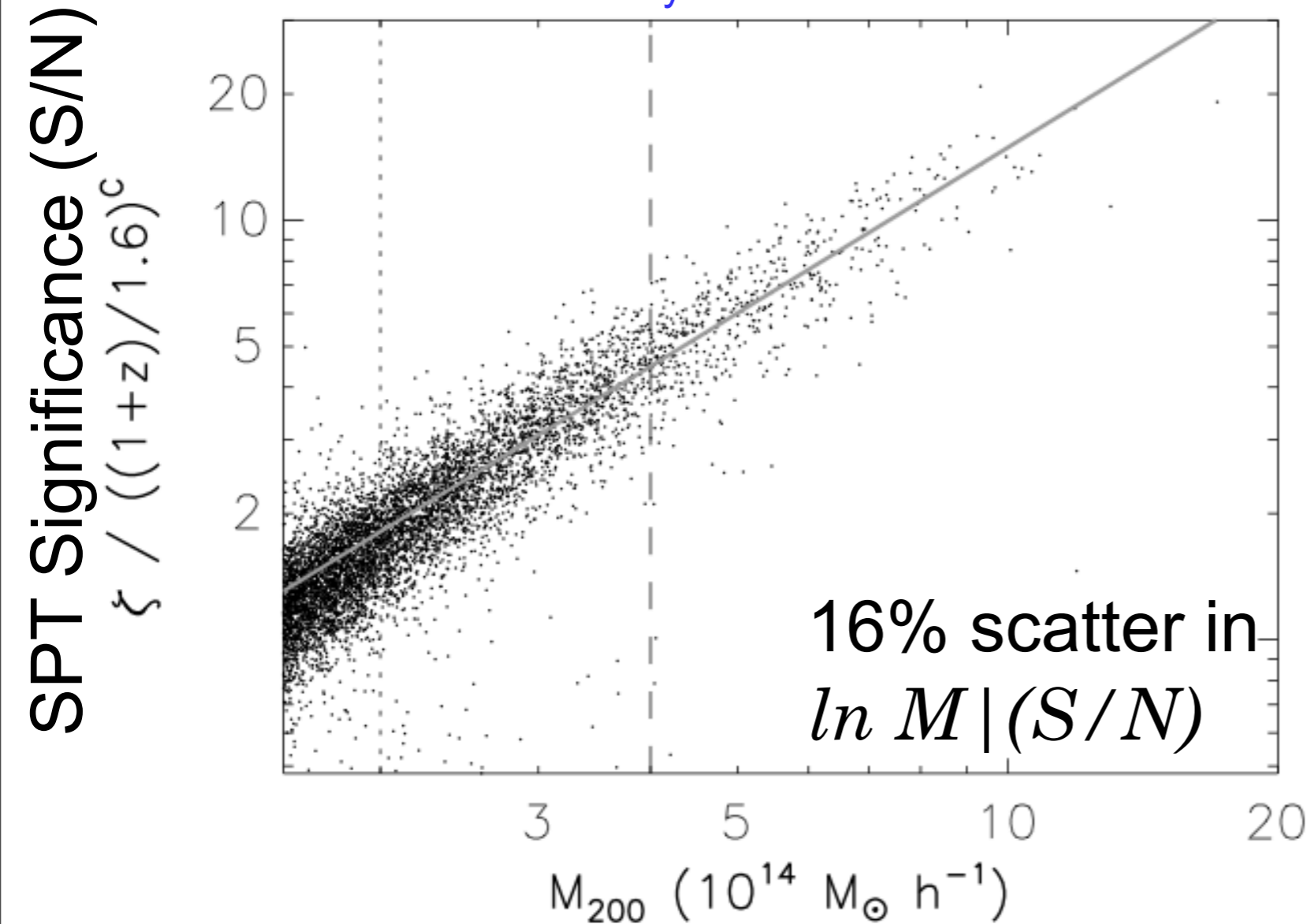

- For any cluster survey, challenge is to link cluster “observable” to cluster mass
- SZ measures cluster pressure ($\sim n_e T_e$), which is expected to have low scatter with mass ($\sim 10\%$)
- SZ Signal-to-noise (S/N) in spatial filtered map is a relatively good mass proxy (Vanderlinde et al 2010)
- **Need to calibrate SZ significance to cluster mass!**

Multi-wavelength Observations: *Mass Calibration*

- **Multi-wavelength mass calibration campaign, including:**

1. **X-ray** with Chandra and XMM (**PI: Benson**)
2. **Weak lensing** from Magellan ($0.3 < z < 0.6$) and HST ($z > 0.6$) (**PI: High, Hoekstra**)
3. **Dynamical masses** from NOAO 3-year survey on Gemini ($0.3 < z < 0.8$) (PI: Stubbs), also VLT at ($z > 0.8$)



Hubble (Optical)

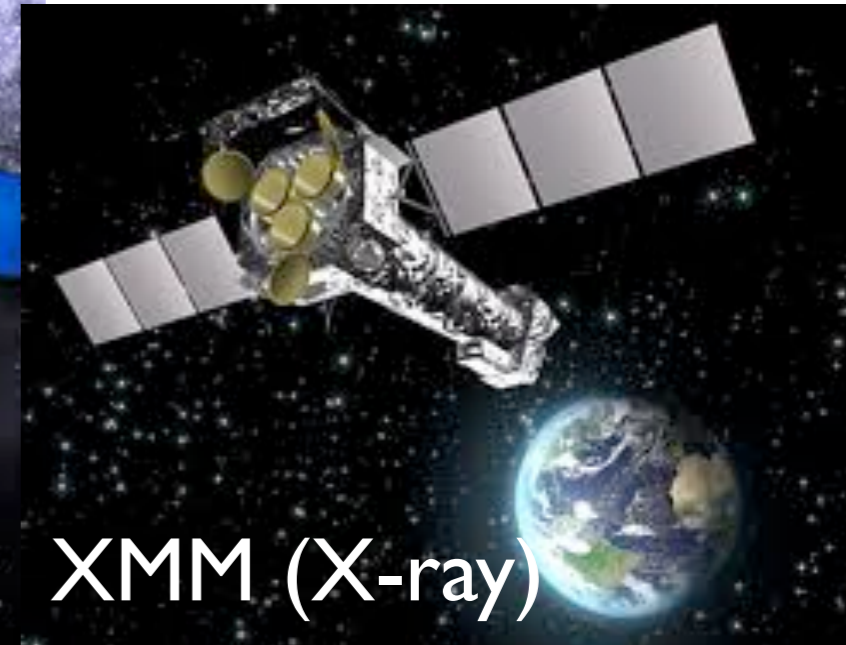

Magellan (Optical)



<http://obs.carnegiescience.edu/Magellan/>

SZ Significance-Mass Calibration

Use X-ray (Y_x - M) relation to calibrate SZ significance-mass relation:

- X-ray masses are calibrated with 10% accuracy using measurements of low-redshift relaxed clusters assuming hydrostatic equilibrium (and cross-checked by weak lensing observations)

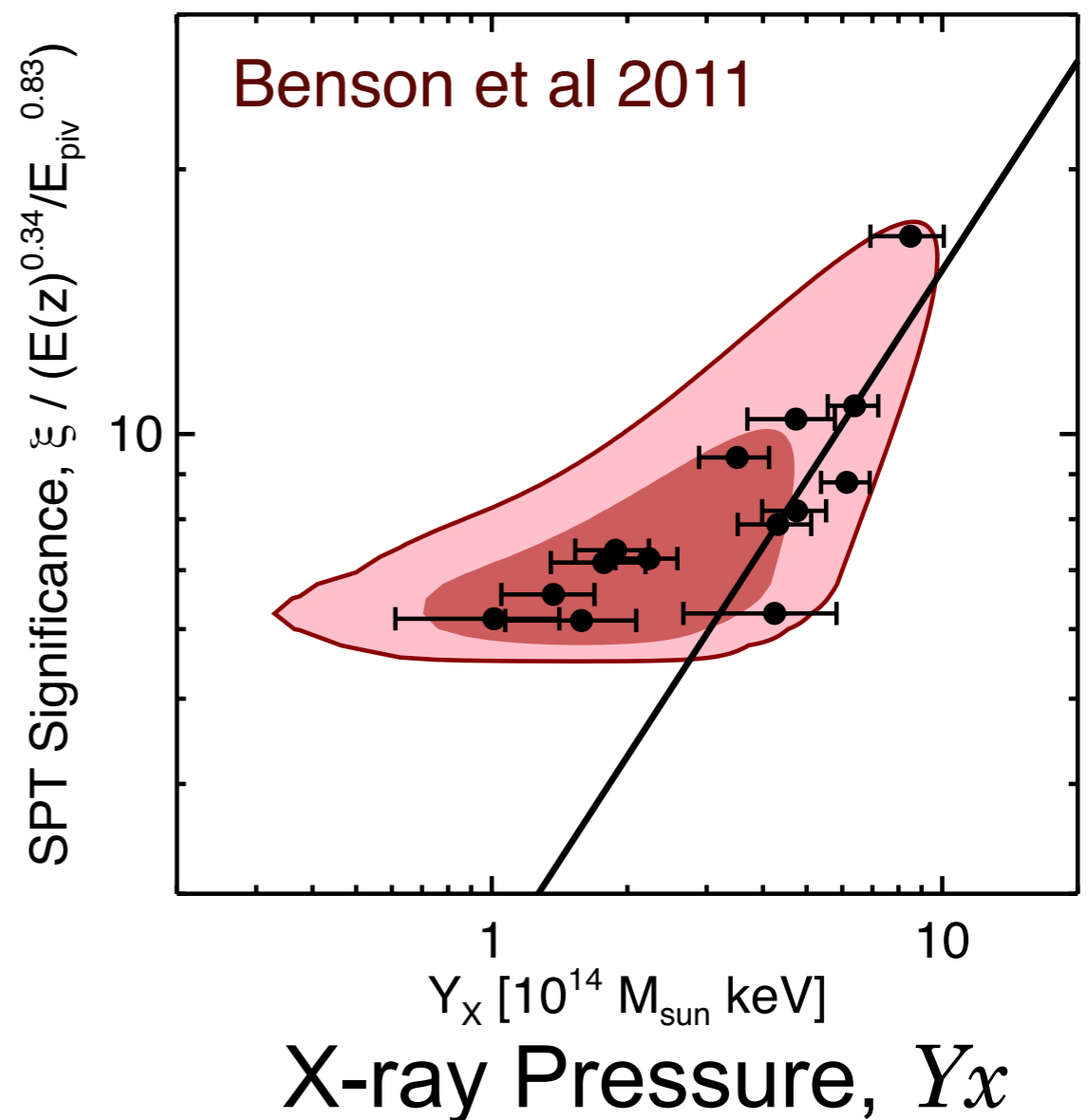
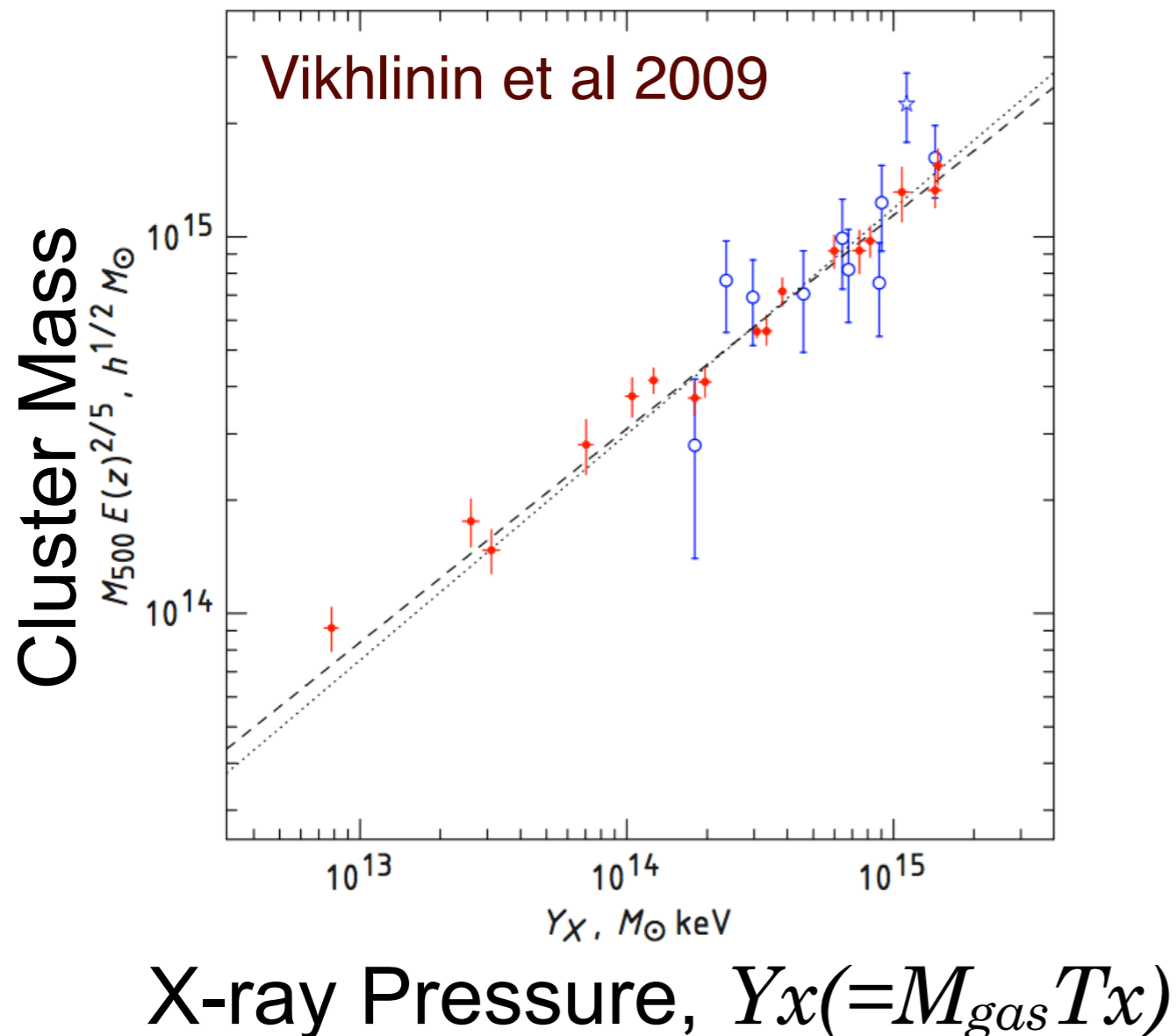

Cosmological Analysis:

Test X-ray Method on 18 clusters (<10% of survey)

Combine Vanderlinde et al 2010 SPT survey results (180 deg², 18 clusters) with Andersson, Benson, et al 2010 X-ray (Y_x) measurements (15 clusters)

Cluster SZ Images

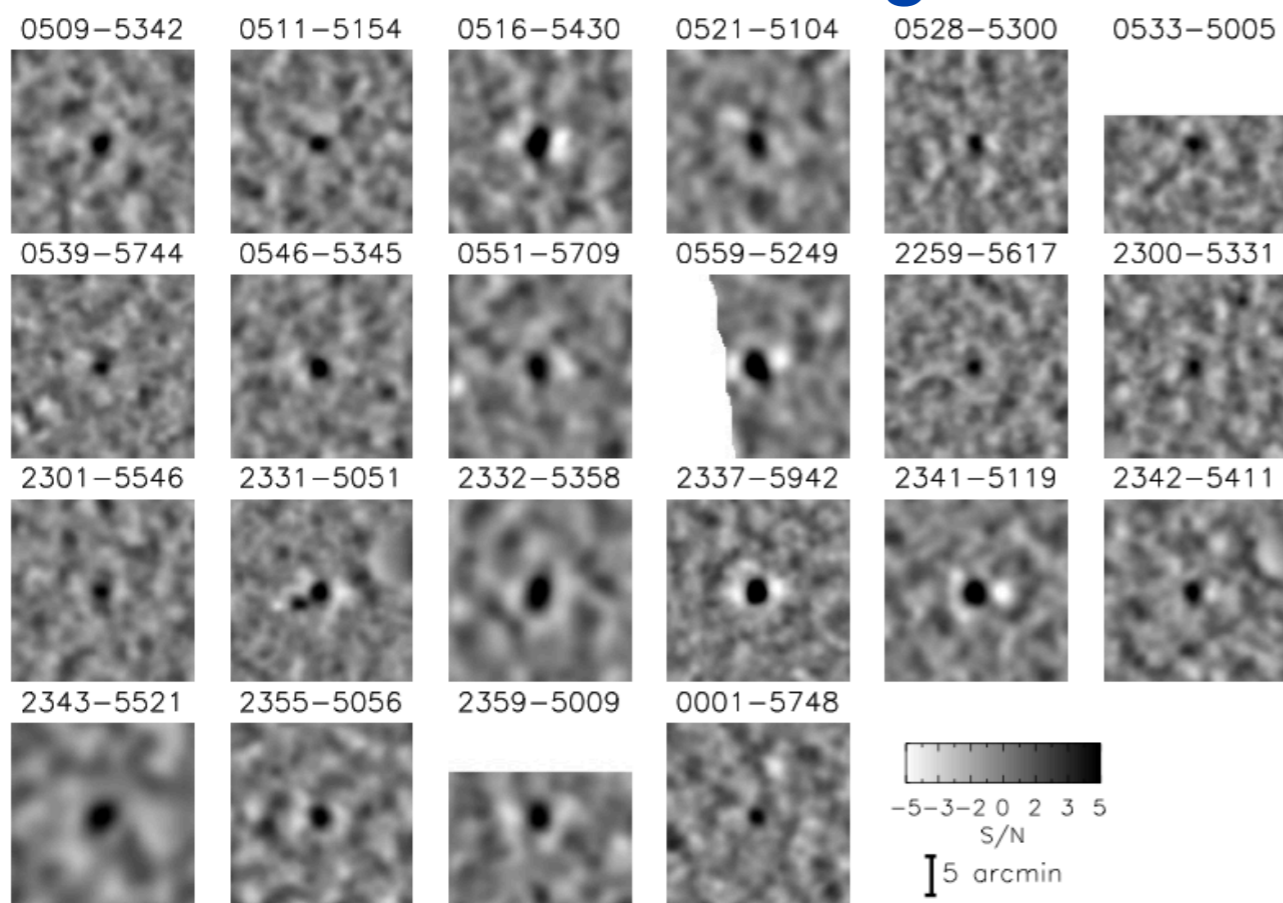

Vanderlinde et al 2010

Cluster X-ray Images

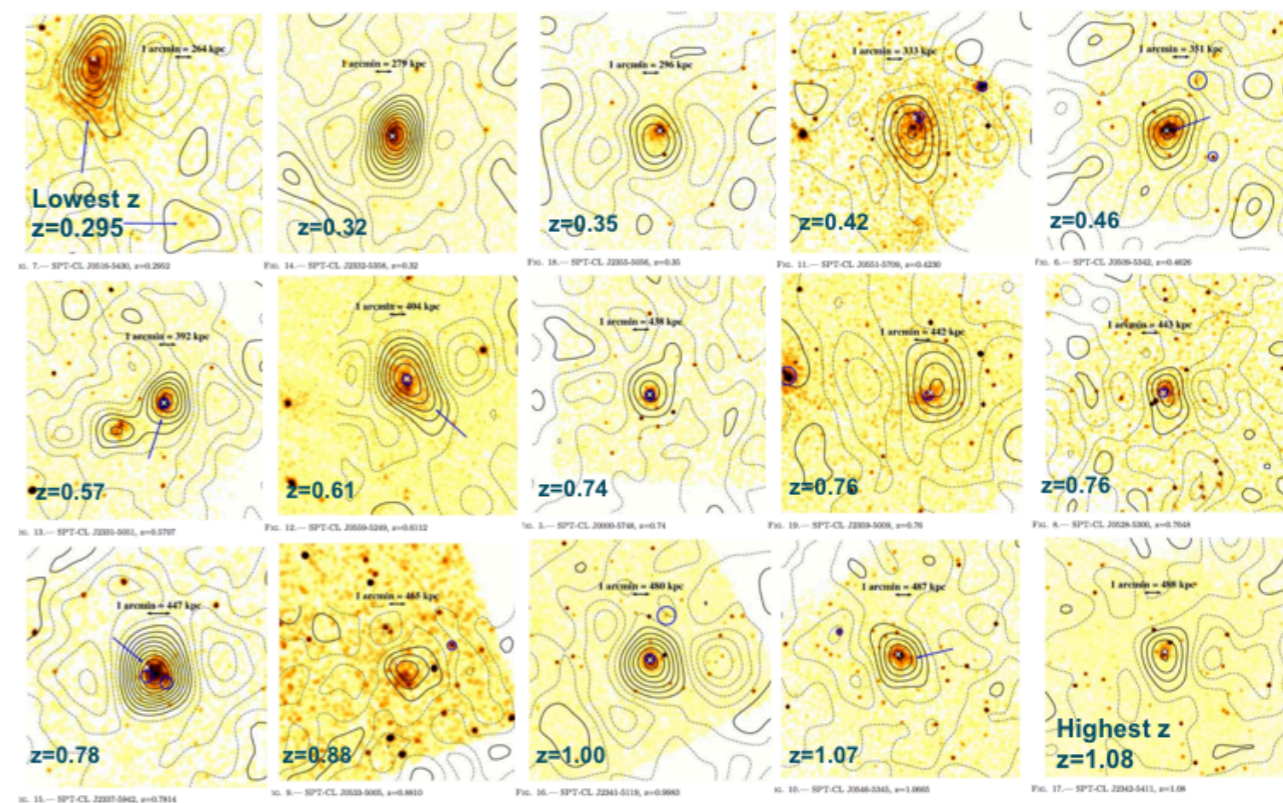

Andersson, Benson, et al 2010

Cosmological Analysis:

Test X-ray Method on 18 clusters (<10% of survey)

Developed Markov-Chain Monte Carlo (MCMC) method to vary cosmology and cluster observable-mass relation simultaneously, while accounting for SZ selection in a self-consistent way

6 Cosmology Parameters
(plus extension parameters)

- Λ CDM Cosmology
 - $\Omega_m h^2, \Omega_b h^2, A_s, n_s, \tau, \theta_s$
- Extension Cosmology
 - $w, \Sigma m_\nu, f_{NL}, N_{eff}$

9 Scaling Relation Parameters

- X-ray (Y_x-M) and SZ ($\xi-M$) relations (4 and 5 parameters):
 - A) normalization,
 - B) slope,
 - C) redshift evolution,
 - D) scatter,
 - F) correlated scatter

Λ CDM Constraints

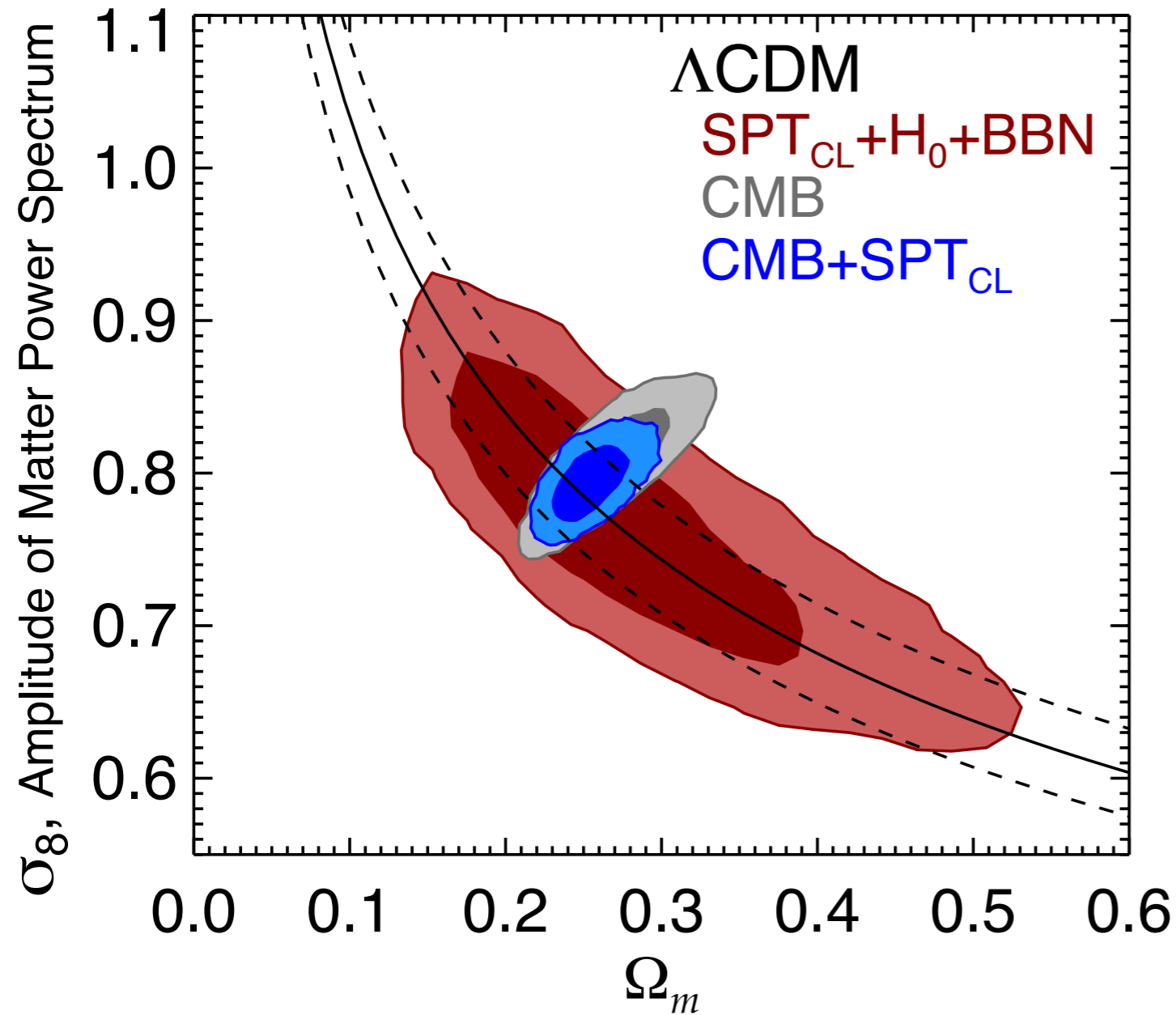

- SPT_{CL}+H₀+BBN Λ CDM fit best constrains:
 $-\sigma_8(\Omega_m/0.25)^{0.30} = 0.785 \pm 0.037$
- Adding SPT_{CL} to CMB improves σ_8 and Ω_m constraint by factor of 1.5:
 $-\sigma_8 = 0.795 \pm 0.016$
 $-\Omega_m = 0.255 \pm 0.016$

σ_8, Ω_m - 68, 95% Confidence Contours

$H_0 = 73.8 \pm 2.4$ km / s Mpc (Riess et al 2011)

CMB: WMAP7 + SPT (Komatsu et al 2011, Keisler et al. 2011)

BBN: $\Omega_b h^2 = 0.022 \pm 0.002$ (Kirkman et al. 2003)

w CDM Constraints

SPT_{CL} data improves dark energy (w, Ω_m) constraints by factor of 1.5

- reduces SNe systematic uncertainty (from +/-0.060 to +/-0.026)

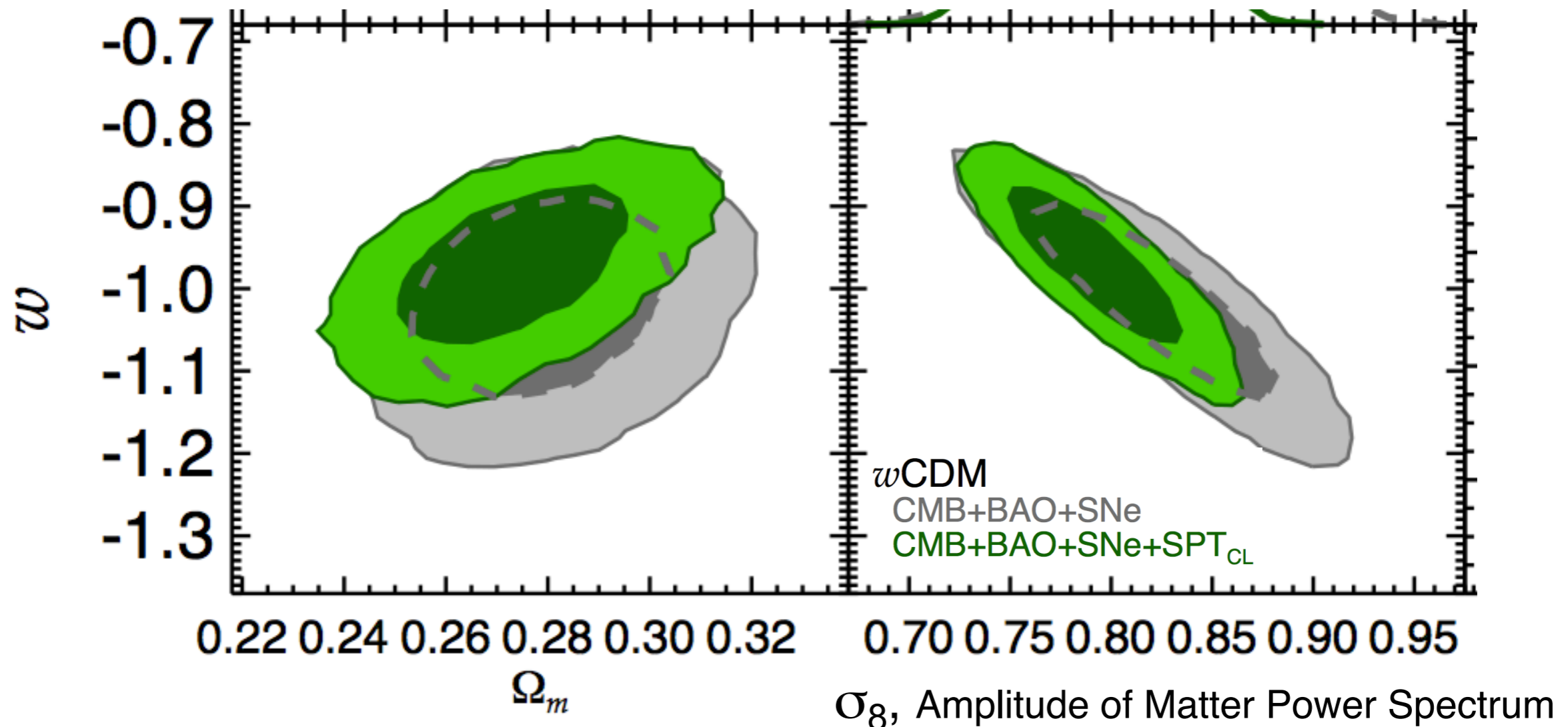

w, σ_8, Ω_m - 68, 95% Confidence Contours

CMB: WMAP7 + SPT (Komatsu et al 2011, Keisler et al. 2011)

BAO: (Percival et al. 2011)

SNe: (Amanullah et al. 2010)

Neutrino Mass (Σm_ν) Constraints

Constraints on neutrino mass from the CMB are improved most significantly by breaking degeneracies with H_0 and σ_8

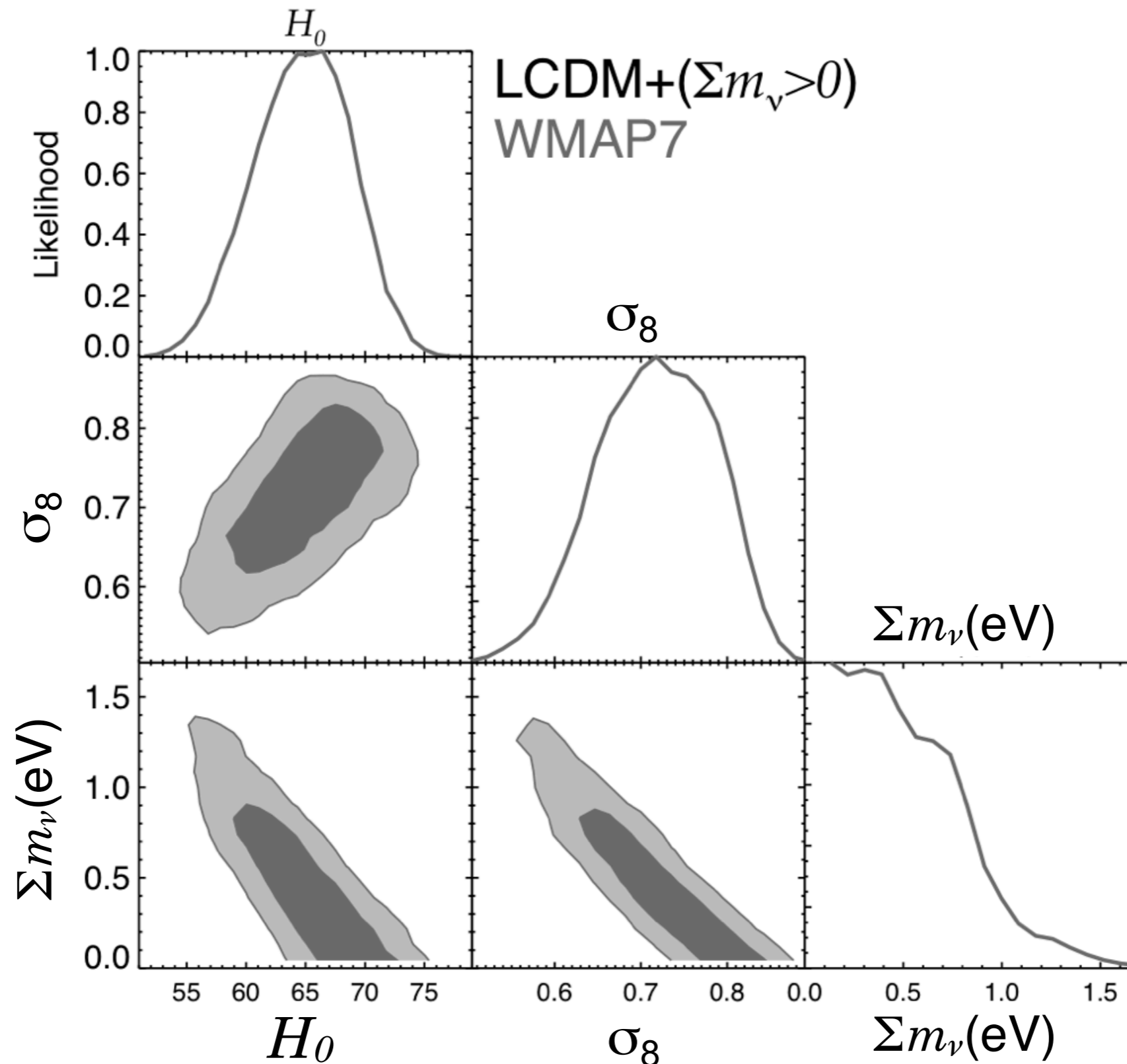

Neutrino Mass (Σm_ν) Constraints

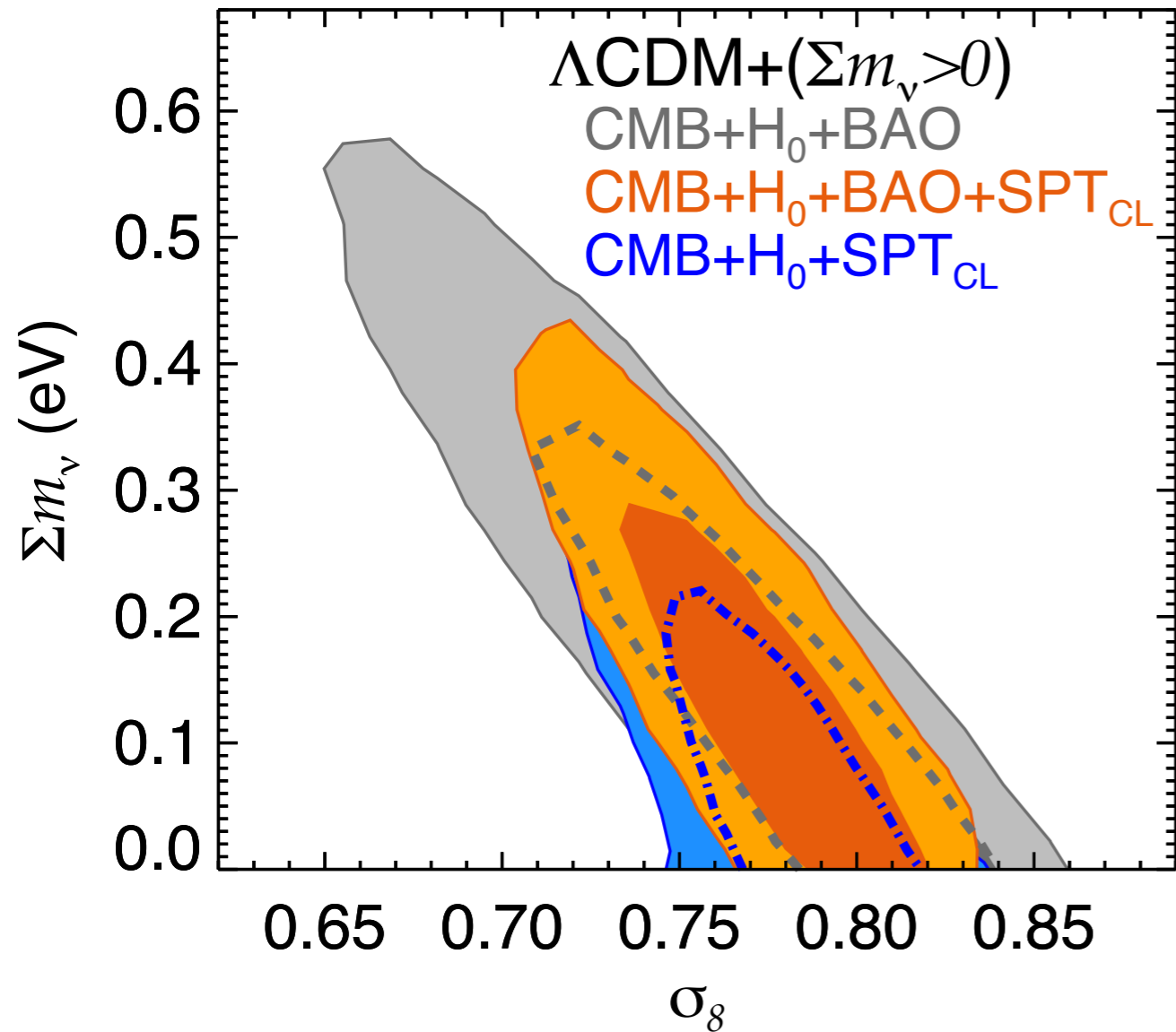

- 95% upper limit on the sum of the neutrino masses (Σm_ν) of:

CMB	< 1.1 eV
+ H_0 +BAO	< 0.45 eV
+ H_0 +SPT _{CL}	< 0.28 eV
- With CMB+ H_0 +SPT_{CL} data
1-sigma standard deviation of +/- 0.09 eV
- Nearing > 0.05 eV mass limit from neutrino oscillations!

w, σ_8, Ω_m - 68, 95% Confidence Contours

CMB: WMAP7 + SPT (Komatsu et al 2011, Keisler et al. 2011)

BAO: (Percival et al. 2011)

$H_0 = 73.8 \pm 2.4$ km / s Mpc (Riess et al 2011)

Benson et al 2011 49

Neutrino Mass and the Number of Species

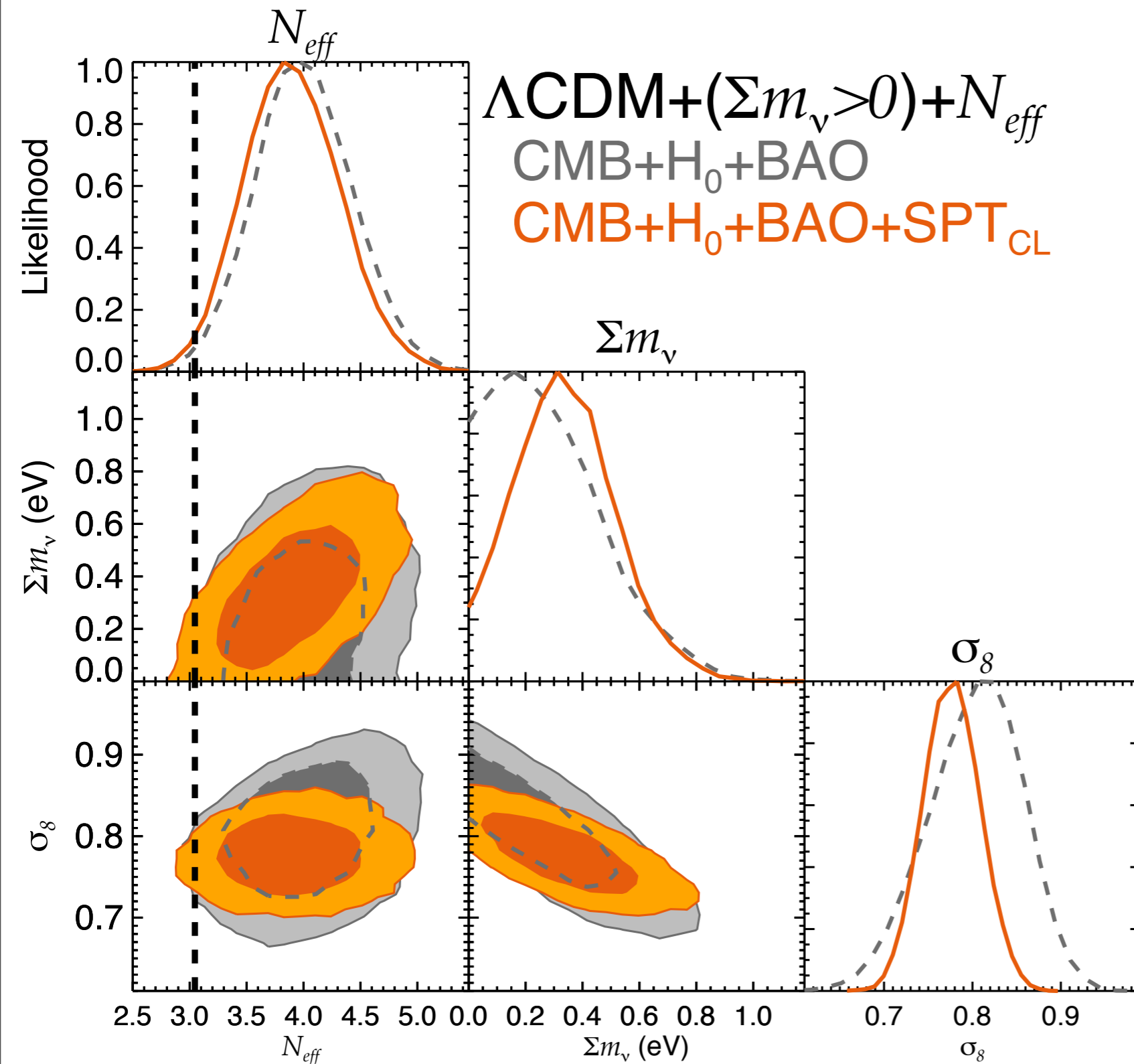

CMB “damping tail”
constrains effective
number of relativistic
species:

- $N_{eff} = 3.91 \pm 0.42$
- $\Sigma m_\nu < 0.63$ eV (at 95% confidence)
- $\Sigma m_\nu = 0.34 \pm 0.17$ eV

2-sigma preference for
non-zero neutrino mass
and an extra neutrino
species!

w CDM:

Error budget for 18 cluster SPT sub-sample

	w CDM SPT _{CL} + H_0 +BBN	
	w	σ_8
Baseline, Section 4,5.1	-1.09 ± 0.36	0.773 ± 0.088
SNe Systematic	—	—
SZ- Y_X Scaling	± 0.19	± 0.066
X-ray Scaling Systematic	± 0.15	± 0.036
Statistical	± 0.27	± 0.046

With 18 clusters (<10% of SPT survey), we are limited by statistical uncertainty - both by the sample size and SZ- Y_x calibration.

To make improvements, we can:

- 1) **Add more clusters** - SPT becomes X-ray mass calibration limited with ~ 60 clusters to $\delta w = \pm 0.15$
- 2) **Improve mass calibration** - improve calibration of mass normalization and its evolution with redshift, each contributes an uncertainty of $\delta w = \pm 0.10$

SPT XVP-80 Sample

Chandra X-ray observations of 80 most significant clusters from first 2000 deg² from SPT survey

- 2.1 Msec Proposal (**PI: Benson**), ~1% of Chandra's total lifetime
- More than double high- z sample from Vikhlinin et al 2009 (80 vs 36)
- **Primary Cosmology Goals:**
 - 1) **Dark Energy, w** - Calibrate SPT cluster mass with 10% accuracy to obtain systematics limited constraint on w of ~15%
 - 2) **Angular Diameter Distance** relation - Combine Y_{sz} , Y_x to use clusters as "standard ruler", constrain geometry of universe to high- z



Weak Lensing: Magellan, HST

Weak lensing observations with Hubble Space Telescope (HST), and Magellan / Megacam

HST Weak Lensing Sample (PI: High)

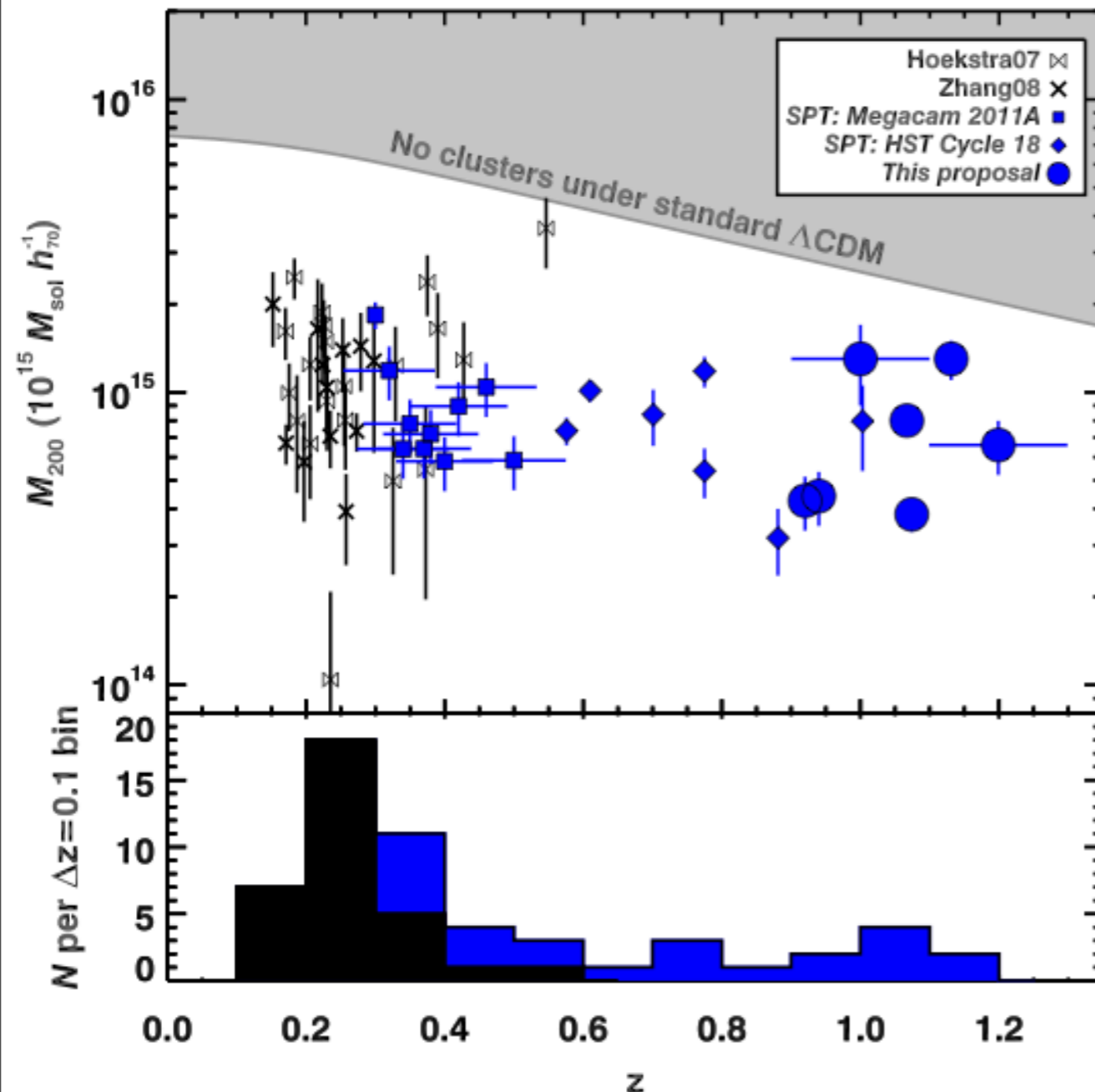

- **Magellan** - 19 clusters ($0.3 < z < 0.6$)

- **HST** - 14 clusters ($0.6 < z < 1.4$)

- **Primary Goals**

1. **Mass Calibration** of the SPT survey ($\sim 5\%$ mean, $\sim 5\%$ redshift evolution)

2. **Distribution of Stars and Galaxies, Hot Gas, Dark Matter** in the most massive clusters in universe from ($0.3 < z < 1.3$) using Spitzer, HST, Chandra, SPT

SPT Cosmological Constraints (projected)

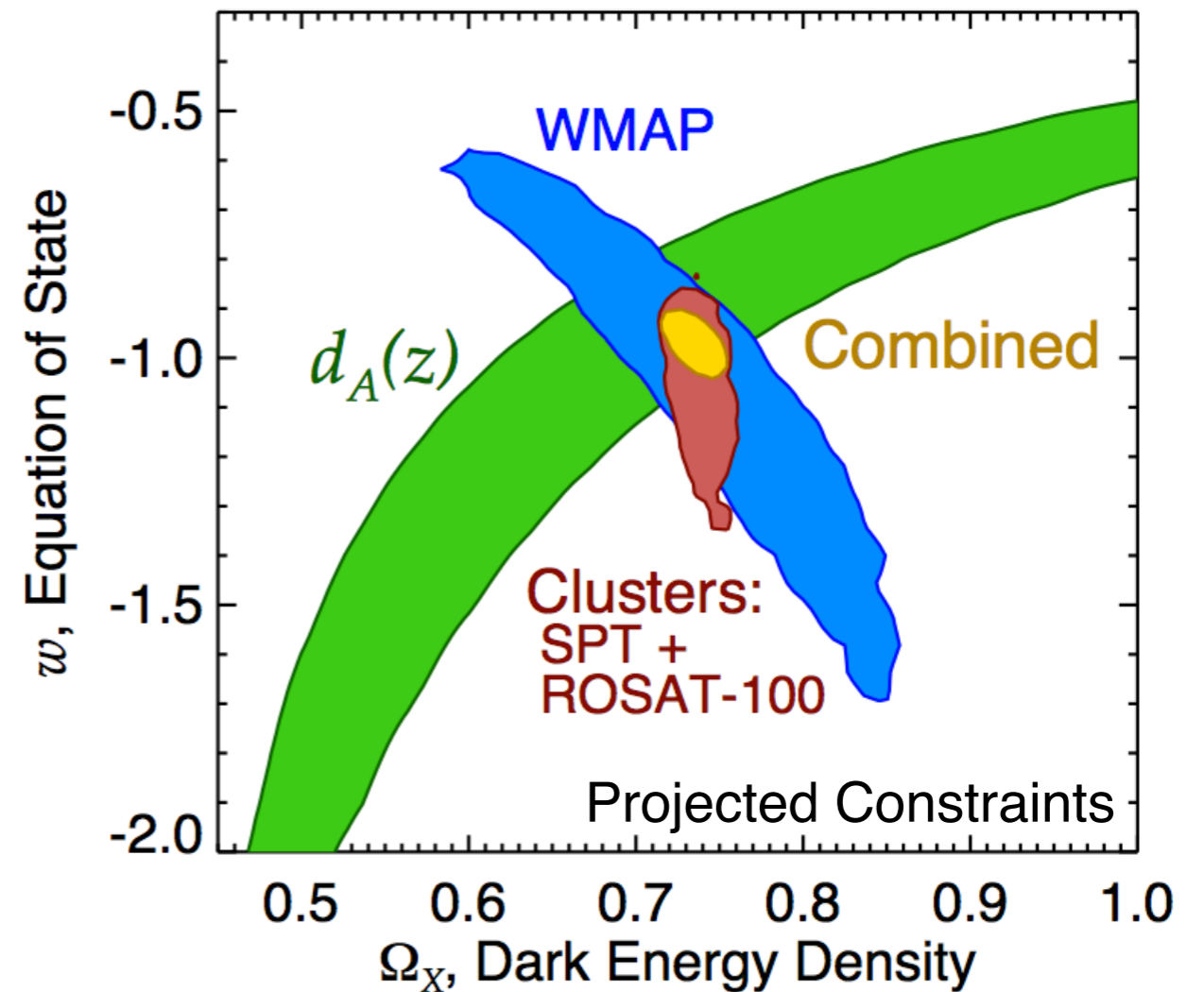
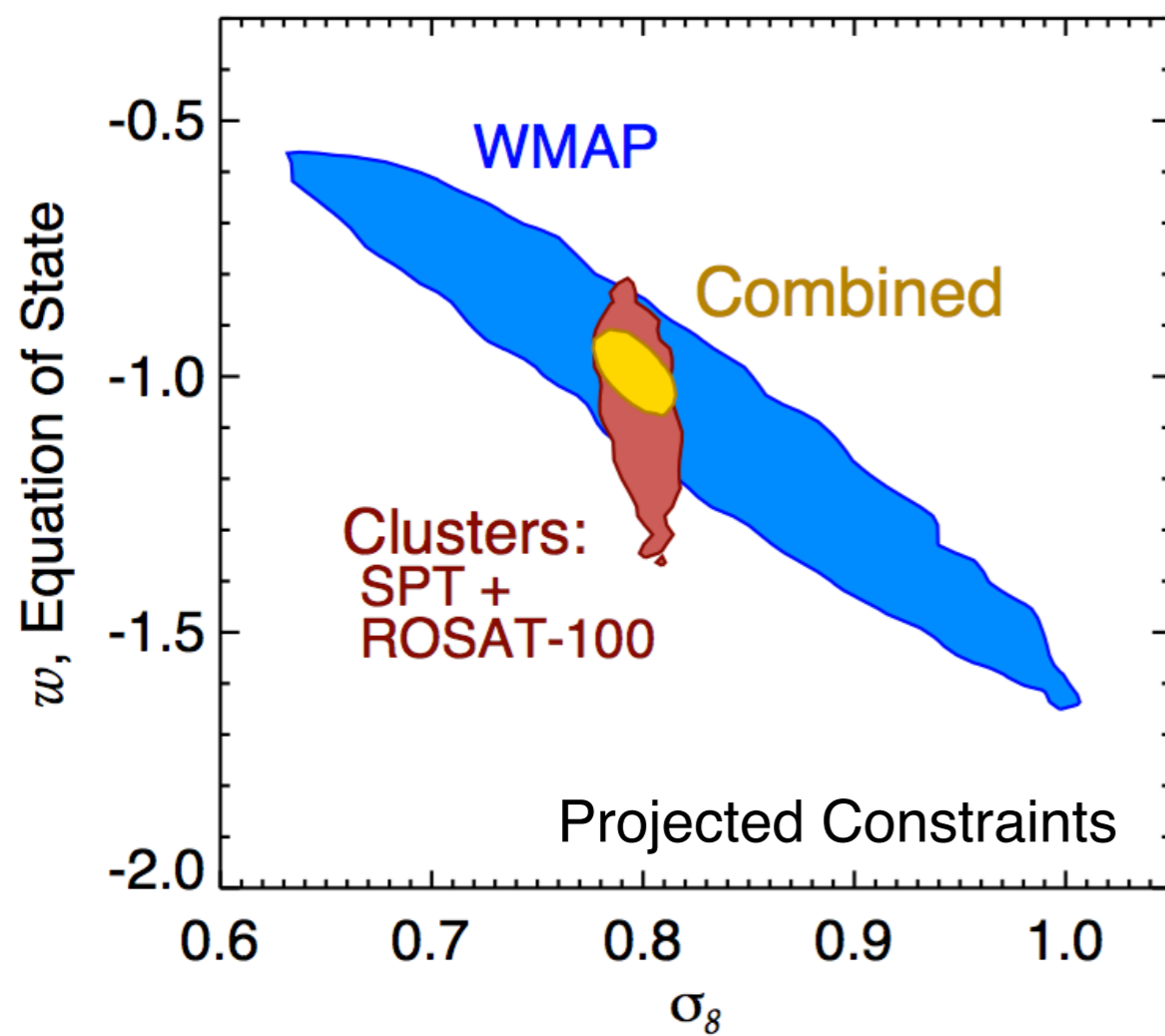

SPT 2500 deg² survey will detect ~ 450 clusters (with $S/N > 5$). Assuming mass calibration uncertainty of 5% mean and 10% evolution ($0 < z < 1$):

- will constrain w to $\pm 5\%$, **independent of geometric cosmological constraints from SNe, BAO**

Dark Energy Survey (DES) and SPT

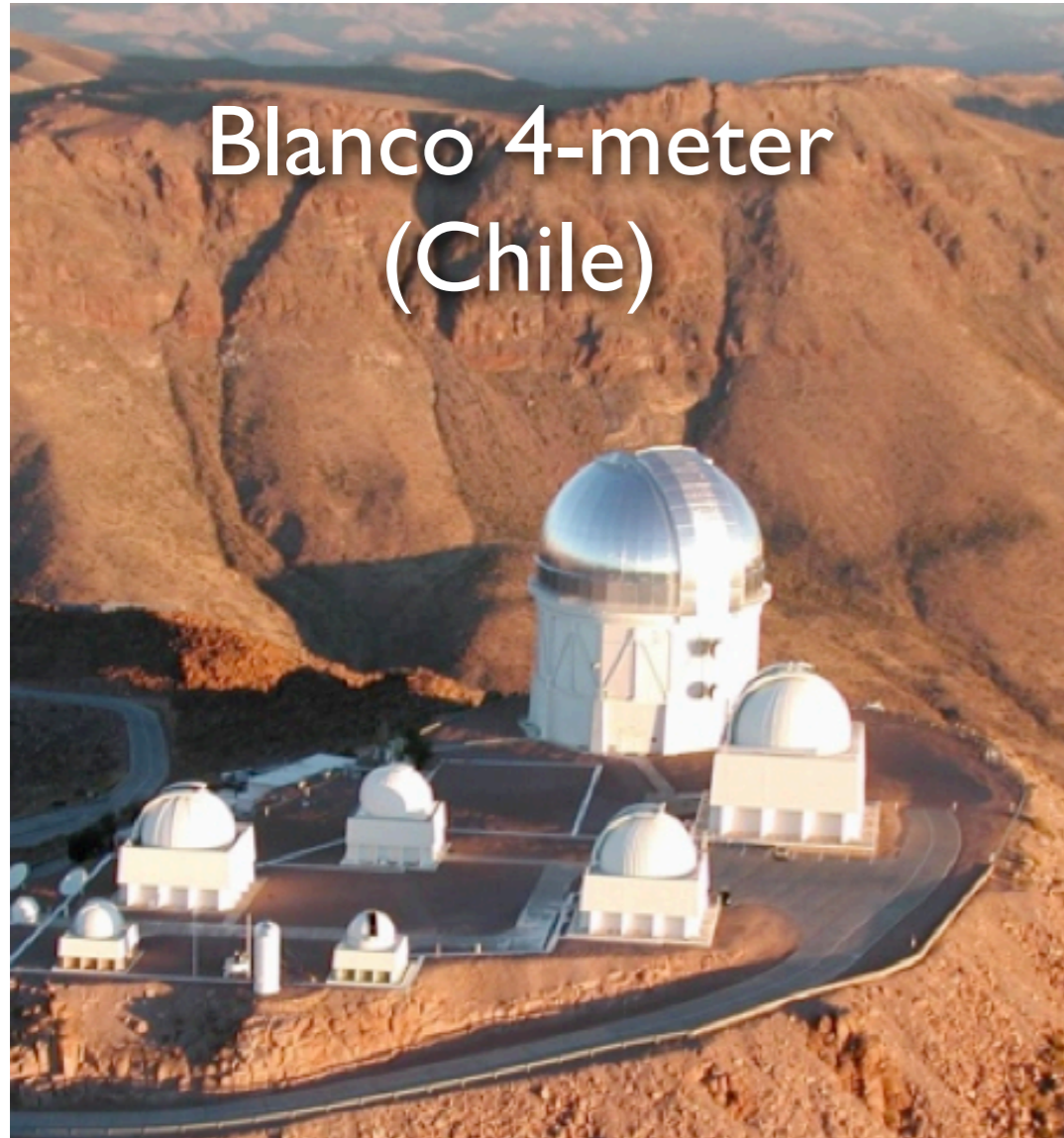

- Wide field (2.2 deg^2) optical camera for 4-meter Blanco telescope (Chile)
- 5-year optical survey (2012-2016) to cover $\sim 5000 \text{ deg}^2$ which will detect $\sim 100,000$ clusters out to $z \sim 1$
- Multiple probes of dark energy (cluster survey, weak lensing, BAO, SN)
 - Coordinated to overlap with SPT Survey Area
 - **X-ray and weak lensing SPT follow-up will improve calibration of DES Richness-Mass relation**
 - Combined DES + SPT Cluster Survey will improve DES figure-of-merit by ~ 3 (Wu, Rozo, Wechsler 2009)

Cosmology from the CMB

1. CMB Anisotropy
2. Clusters
- 3. CMB Lensing**

Lensing of the CMB

$17^\circ \times 17^\circ$

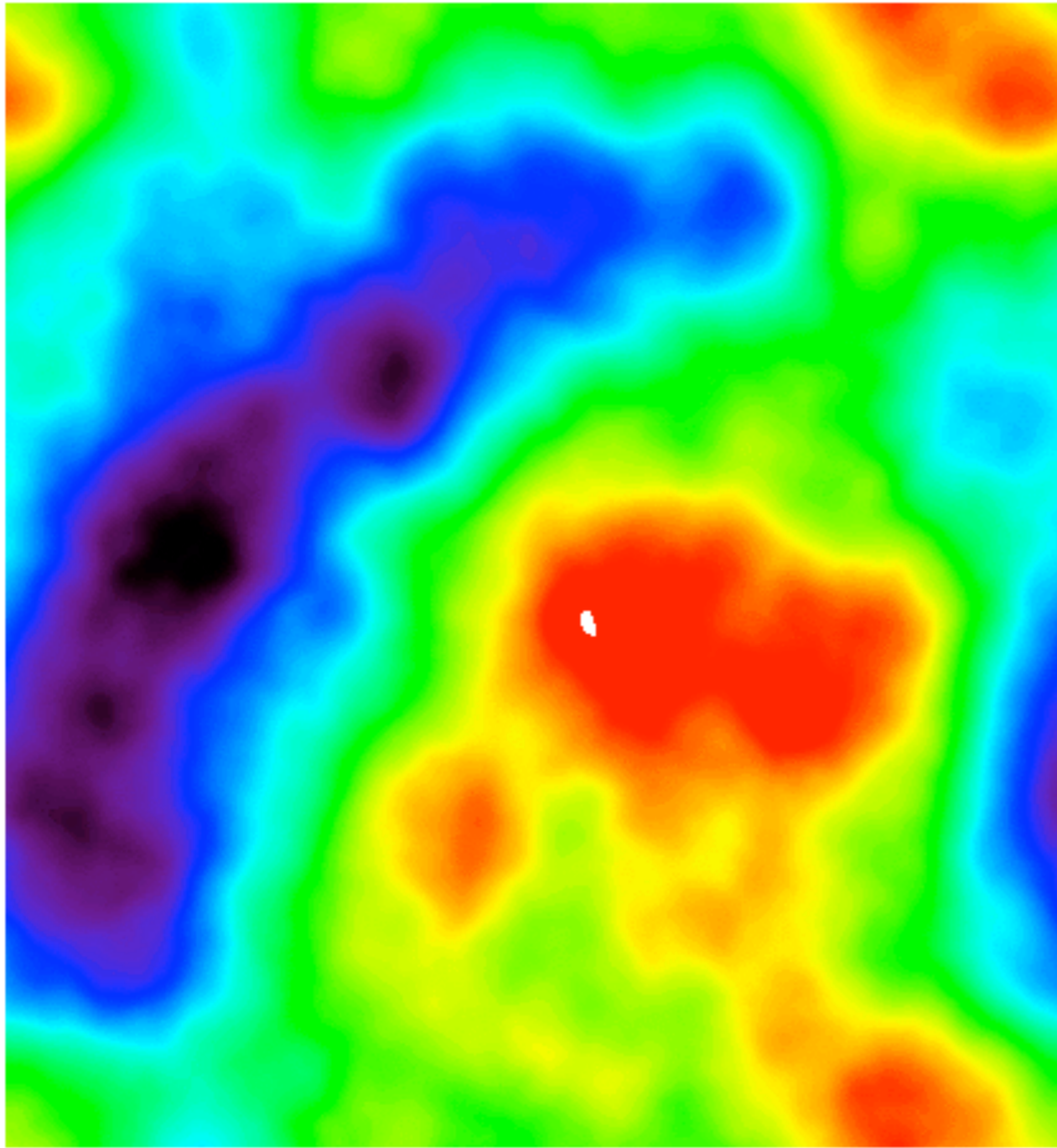

lensing potential

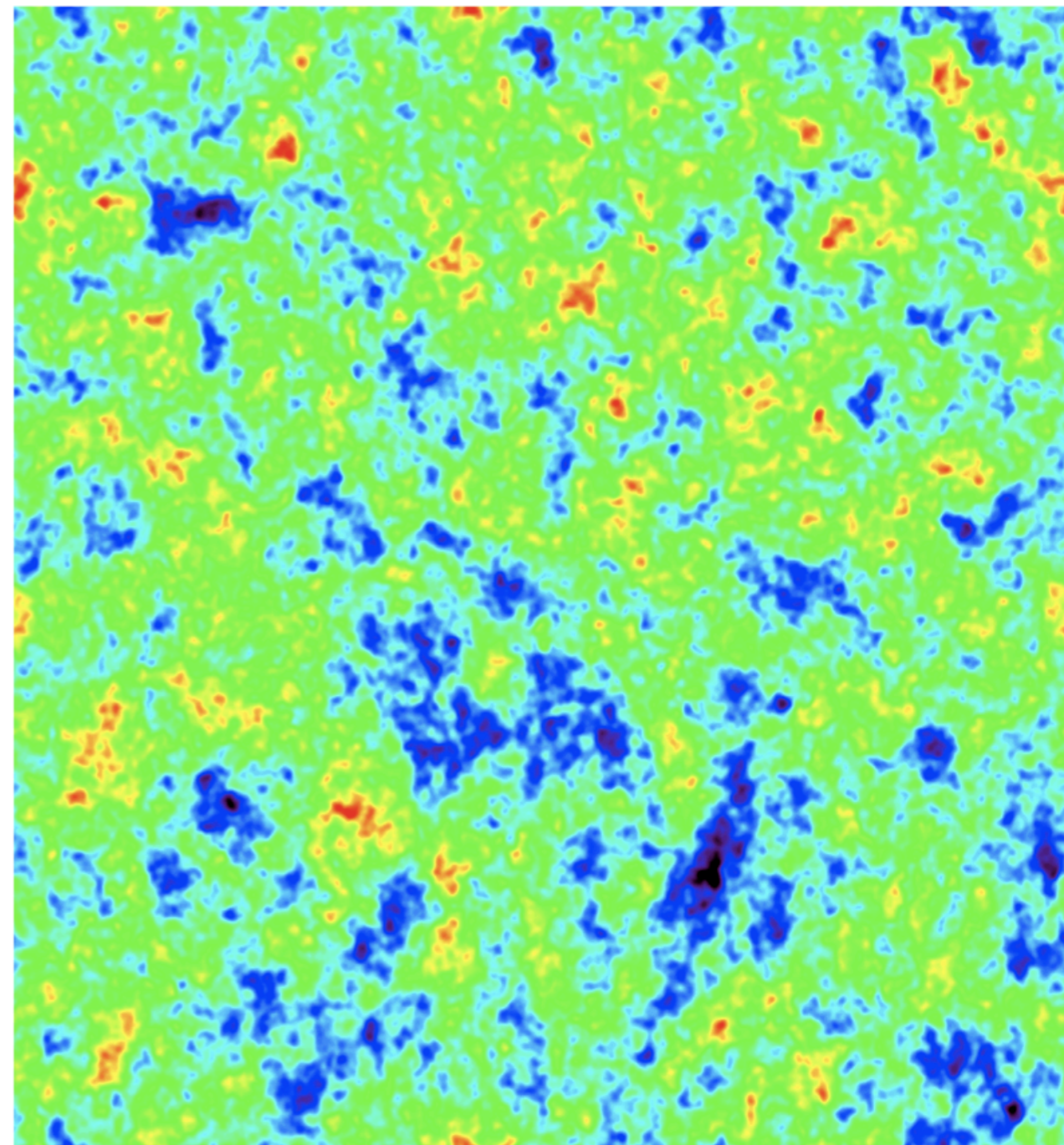

unlensed cmb

from Alex van Engelen

Lensing of the CMB

17°x17°

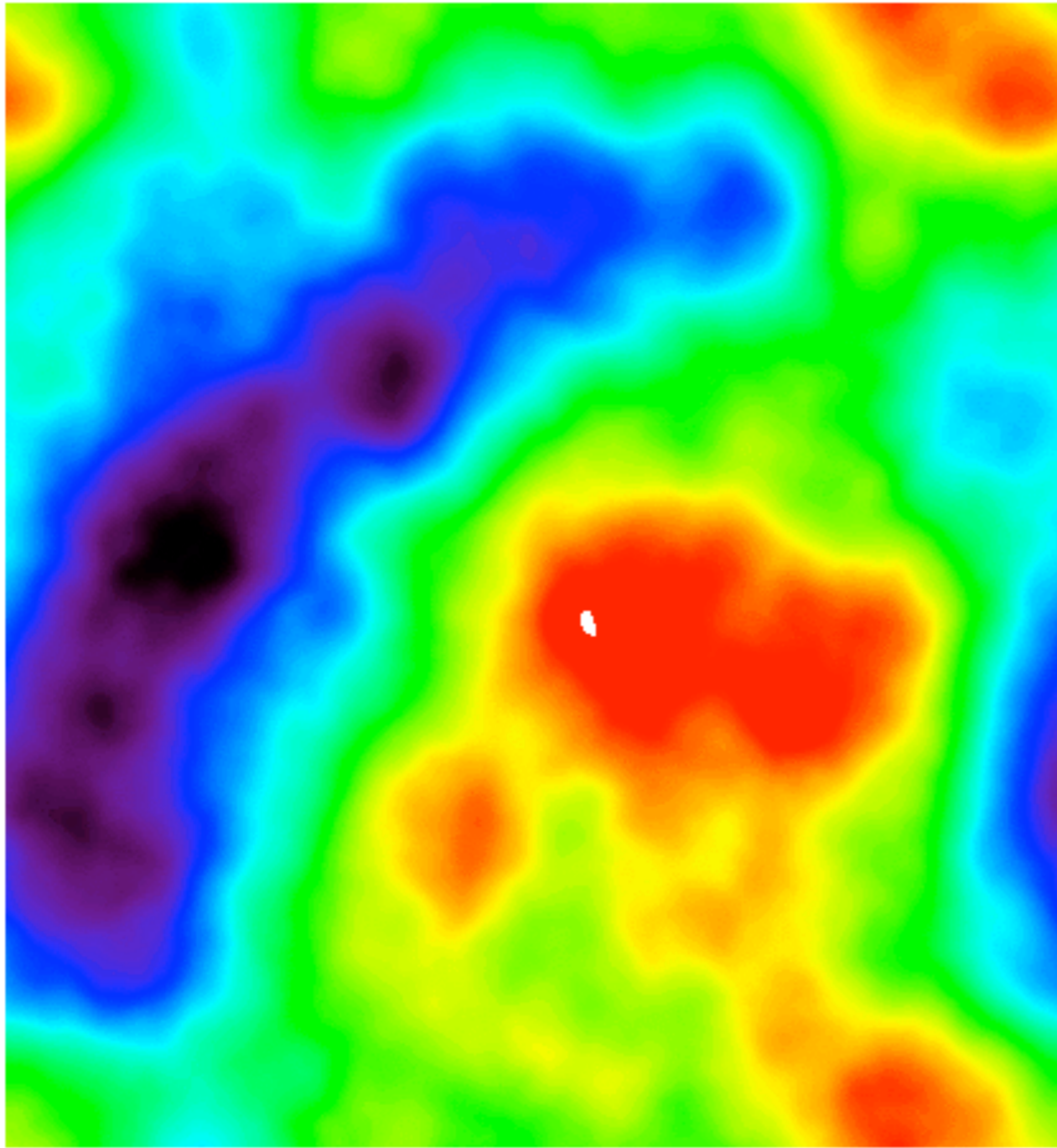

lensing potential

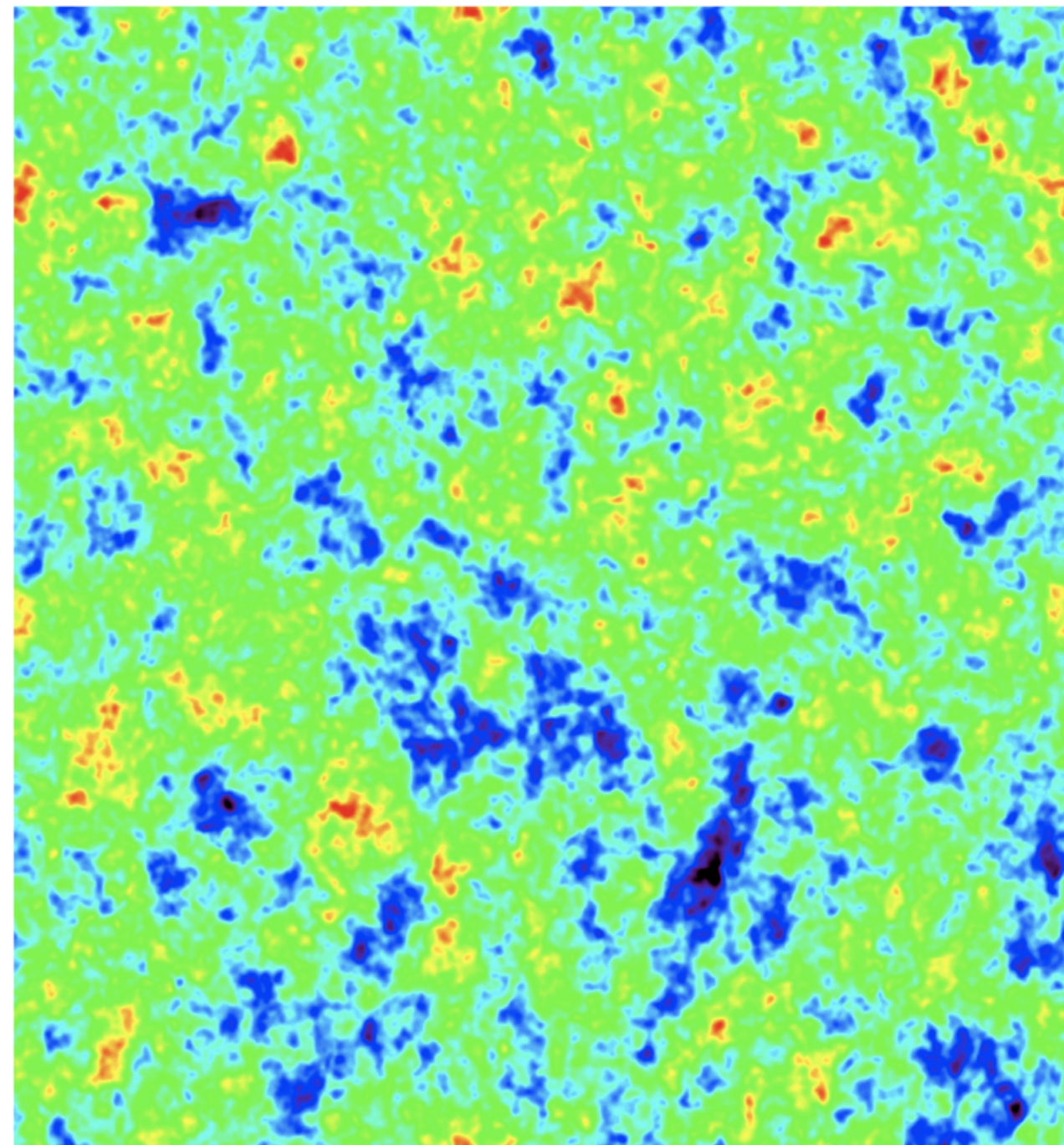

lensed cmb

from Alex van Engelen

Spatial Correlations in the CMB

CMB is a unique source for lensing:

- Gaussian, well-understood power spectrum
- From a redshift which is: (a) unique, (b) known, and (c) highest

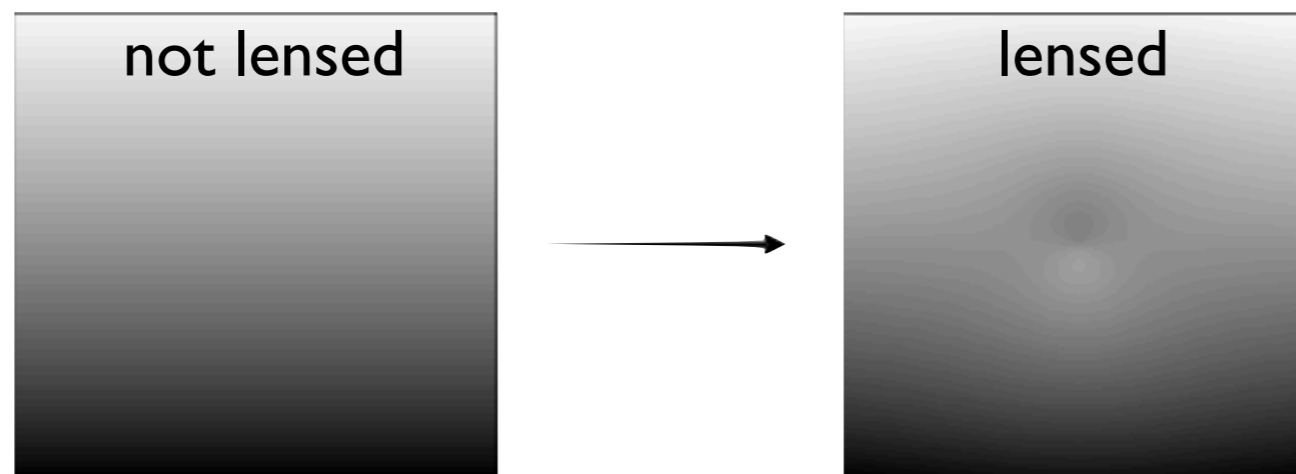
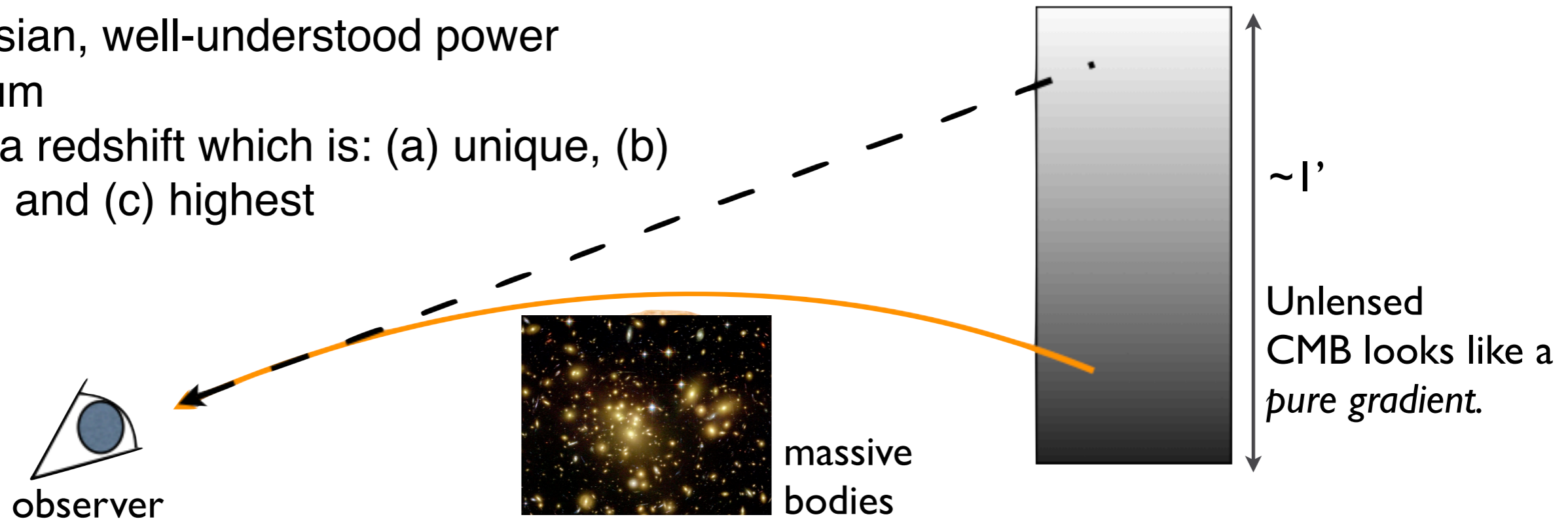

Small-scale wiggles are correlated with large-scale gradient.

SPT Lensing Power Spectrum

- high significance detection of non-Gaussianity in the CMB induced by gravitational lensing
- based on $\sim 1/5$ of SPT area, single-frequency only, heavily-filtered
- project $>30 \sigma$ detection with 2500 deg^2 survey

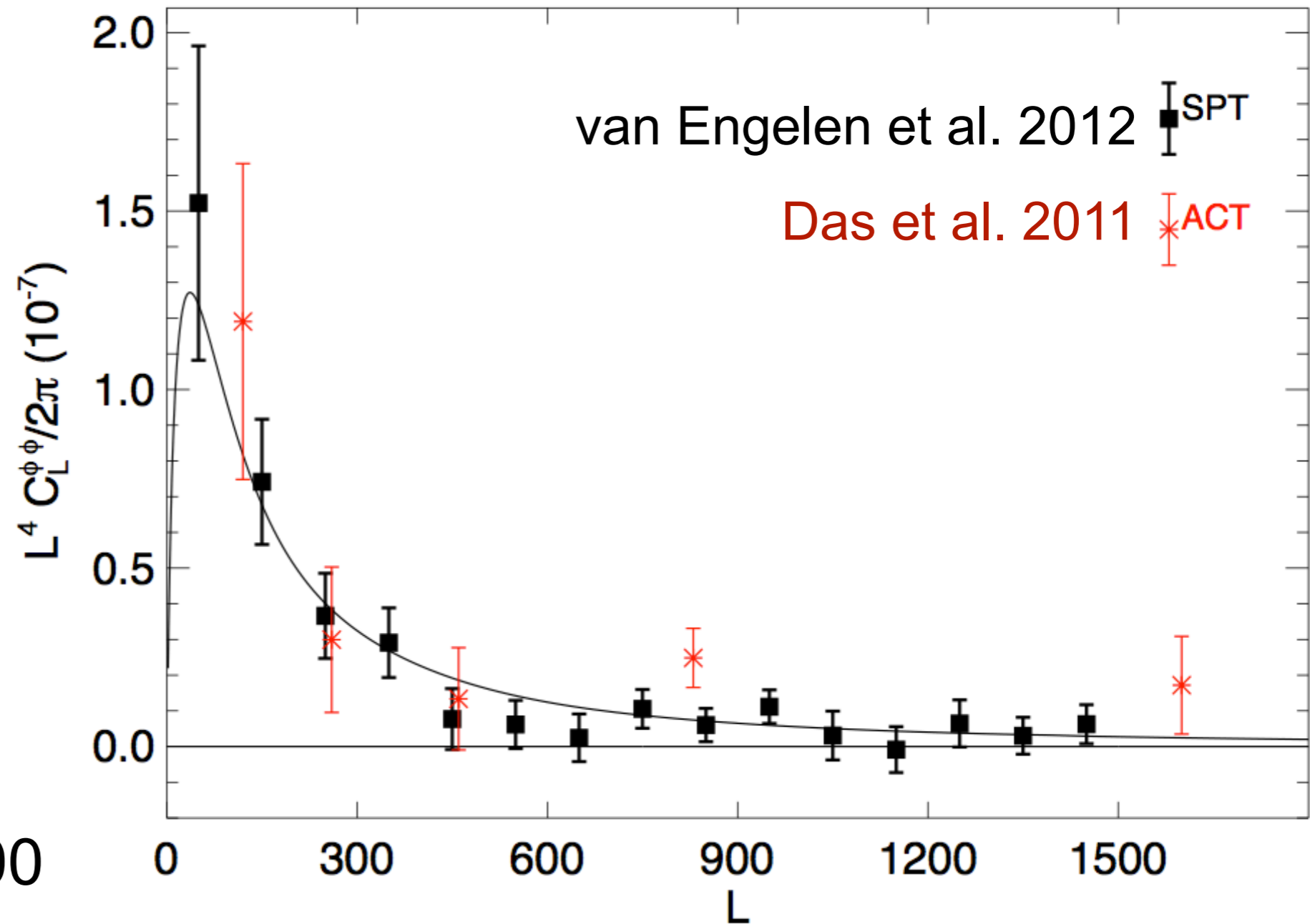

van Engelen et al 2012, astro-ph/1202.0546

Neutrinos & CMB Lensing

CMB Lensing Potential Power (2D)

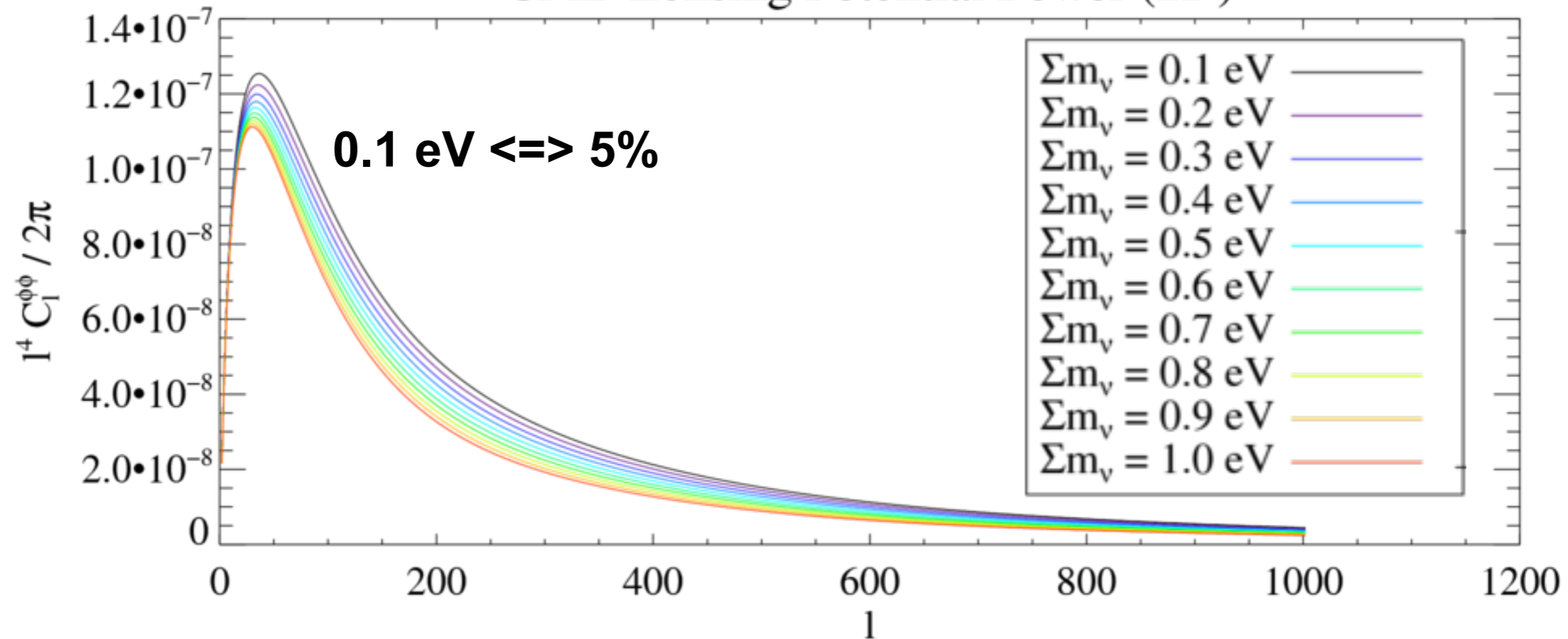

- Peaks at $l=40$ ($k_{\text{eq}} = [300 \text{ Mpc}]^{-1}$ at $z = 2$): coherent over \sim several degree scales
- Lensing signal comes from structure over a broad redshift range ($\sim 0.5 < z < \sim 6$)

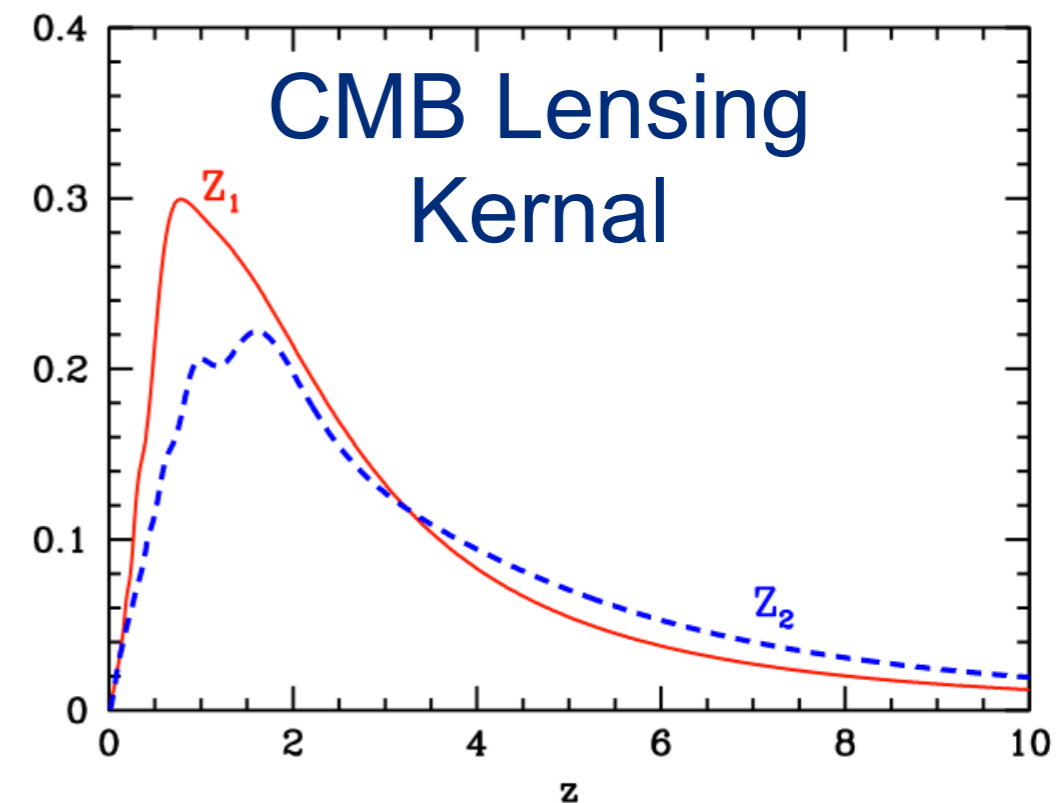

CMB Lensing X Galaxies

← 16° →

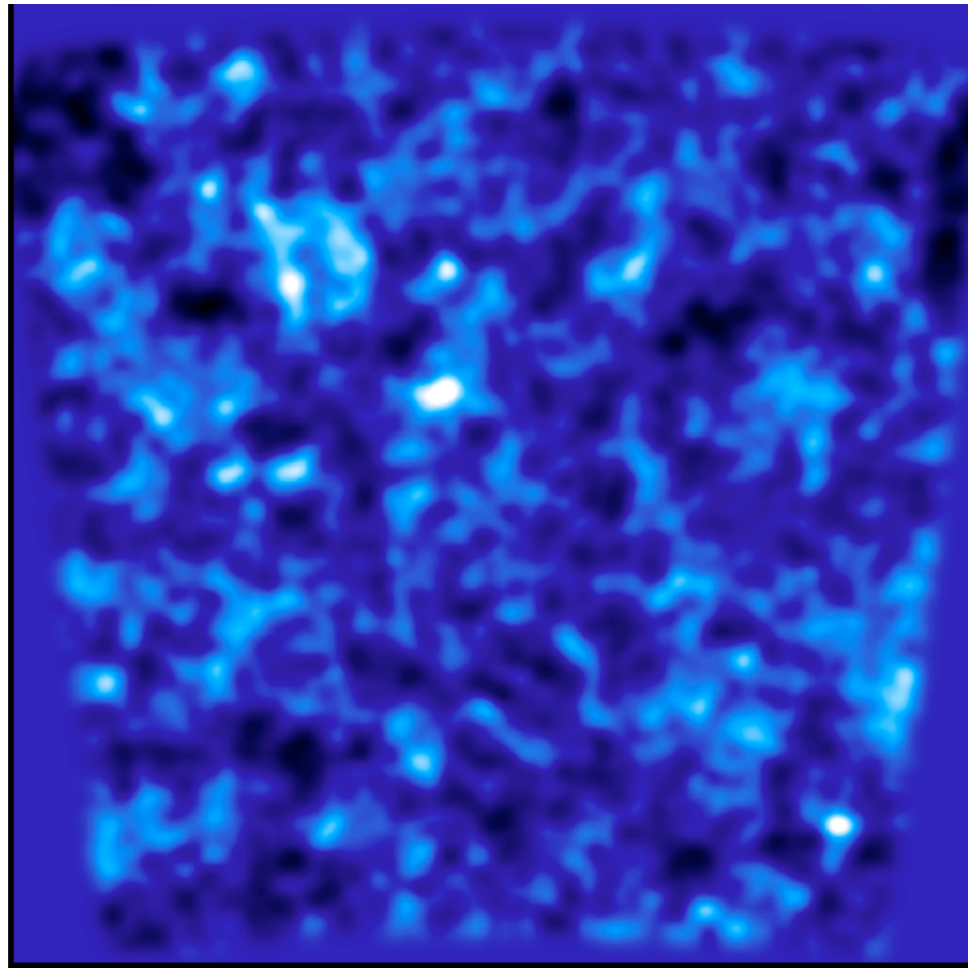

CMB convergence map
(no noise)

(sims from Matt Becker & DES)

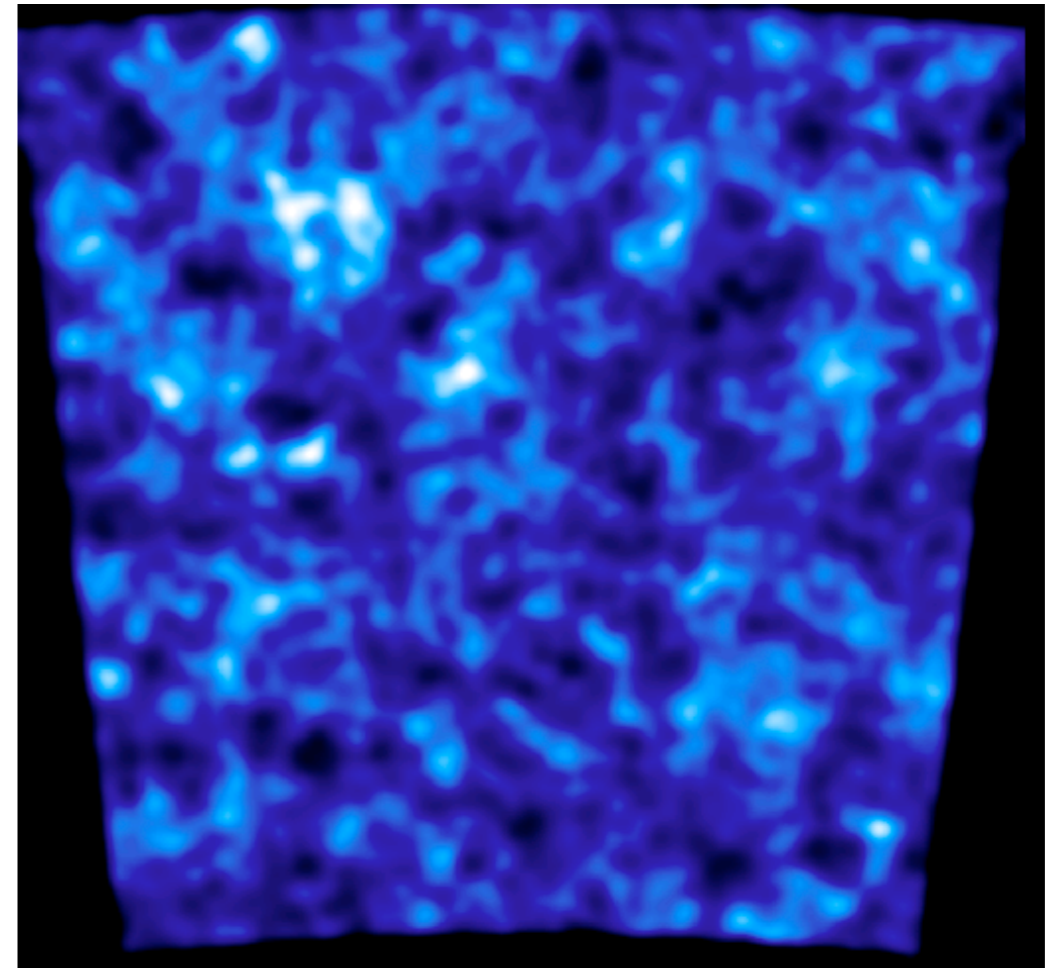

Galaxy number density
from DES mocks

($i < 23$)

Lensing X Tracers of Large Scale Structure

- DES (overlap with full SPT-SZ 2500 sq deg)
- SUMSS (equivalent of NVSS for southern sky)
- **(23h,-55d) 100 sq deg deep field:**
 - **Spitzer IRAC**
 - 3.6, 4.5 μm - data being taken!
 - **Herschel SPIRE**
 - 250, 350, 500 μm - survey about to start

Cosmology from the CMB

- 1. CMB Anisotropy**
- 2. Clusters**
- 3. CMB Lensing**

Cosmology from Growth of Structure

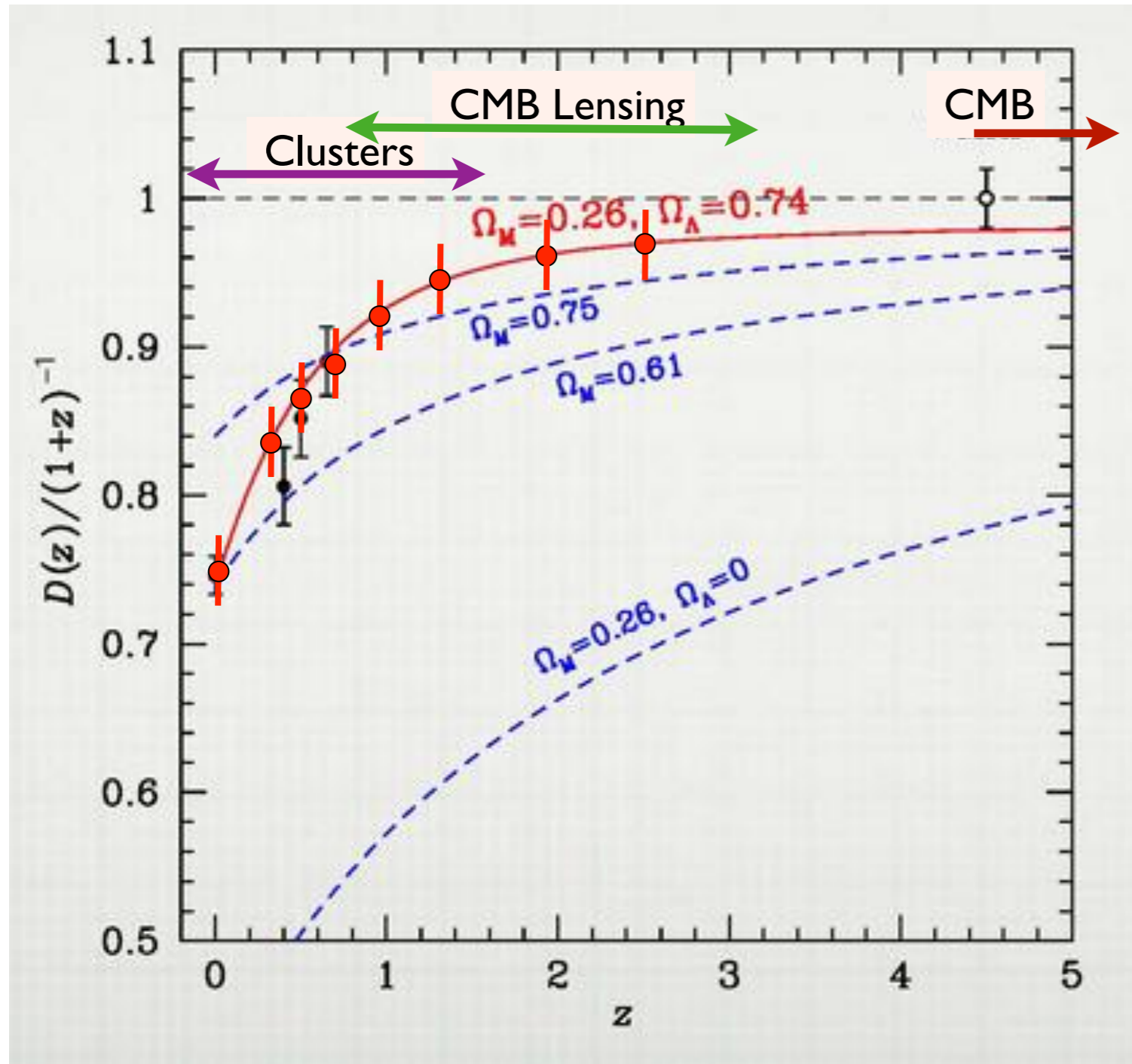

Credit: Vikhlinin et al 2009

- **From the CMB -to- Lensing of CMB -to- Clusters:**
 - Traces matter power spectrum, and growth of structure or $\sigma_8(z)$, from 400,000 to 14 billion years after Big Bang
 - Powerful test of cosmology, both a systematic check and complementary to distance-relation based tests (BAO, SNe)

The Next Frontier for CMB Lensing: The Polarization of the CMB

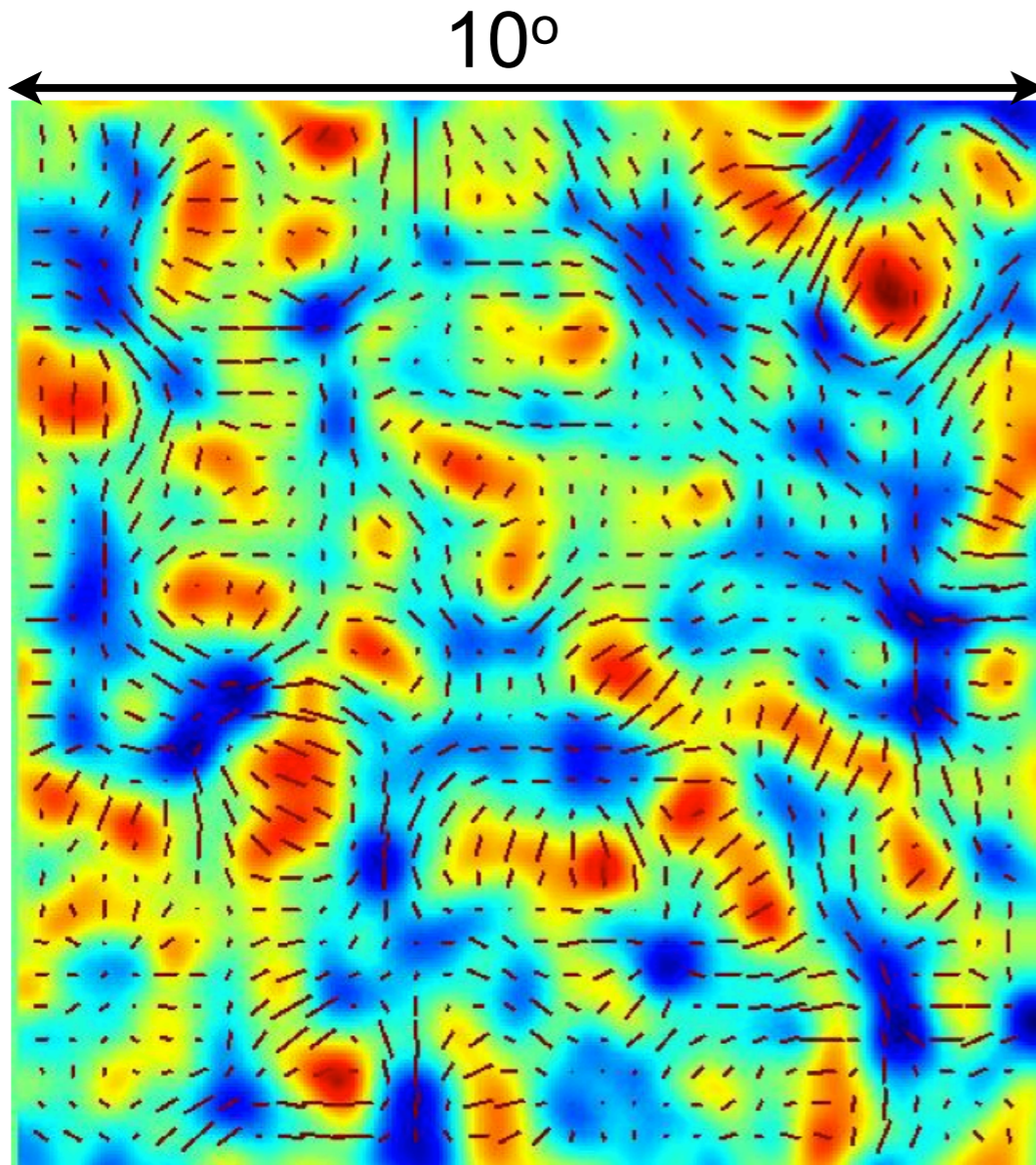

- Quadrupole anisotropy introduces a polarization from Thomson scattering near surface of last scattering
- Polarization pattern can be decomposed into “E” and “B” modes, that have only grad and curl components
- Density fluctuations produce only “E” modes, no handedness
- “B” modes can be created by:
 - primordial gravity waves from Inflation
 - lensing of the CMB from large scale structure

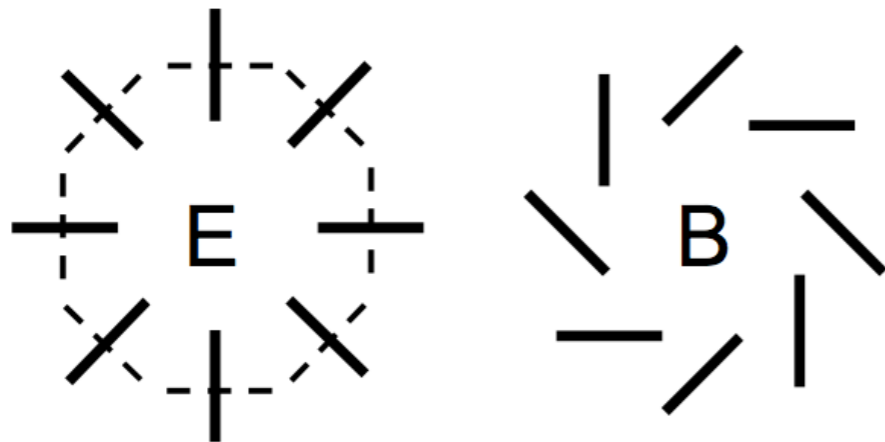

Smith et al 2008

The Effect of Lensing on the CMB Power Spectrum: **B-modes from Lensing**

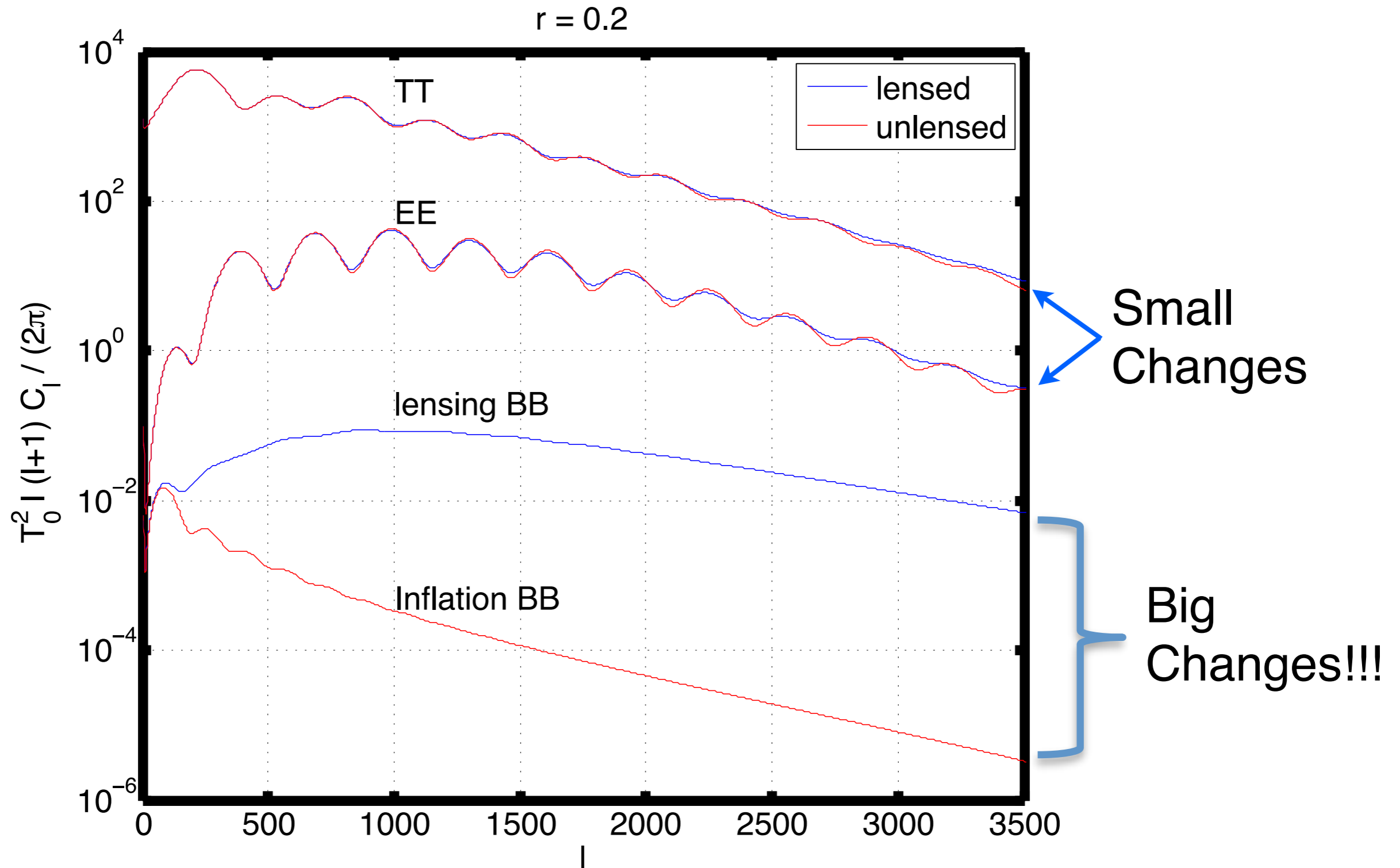

Inflation and High Energy Physics

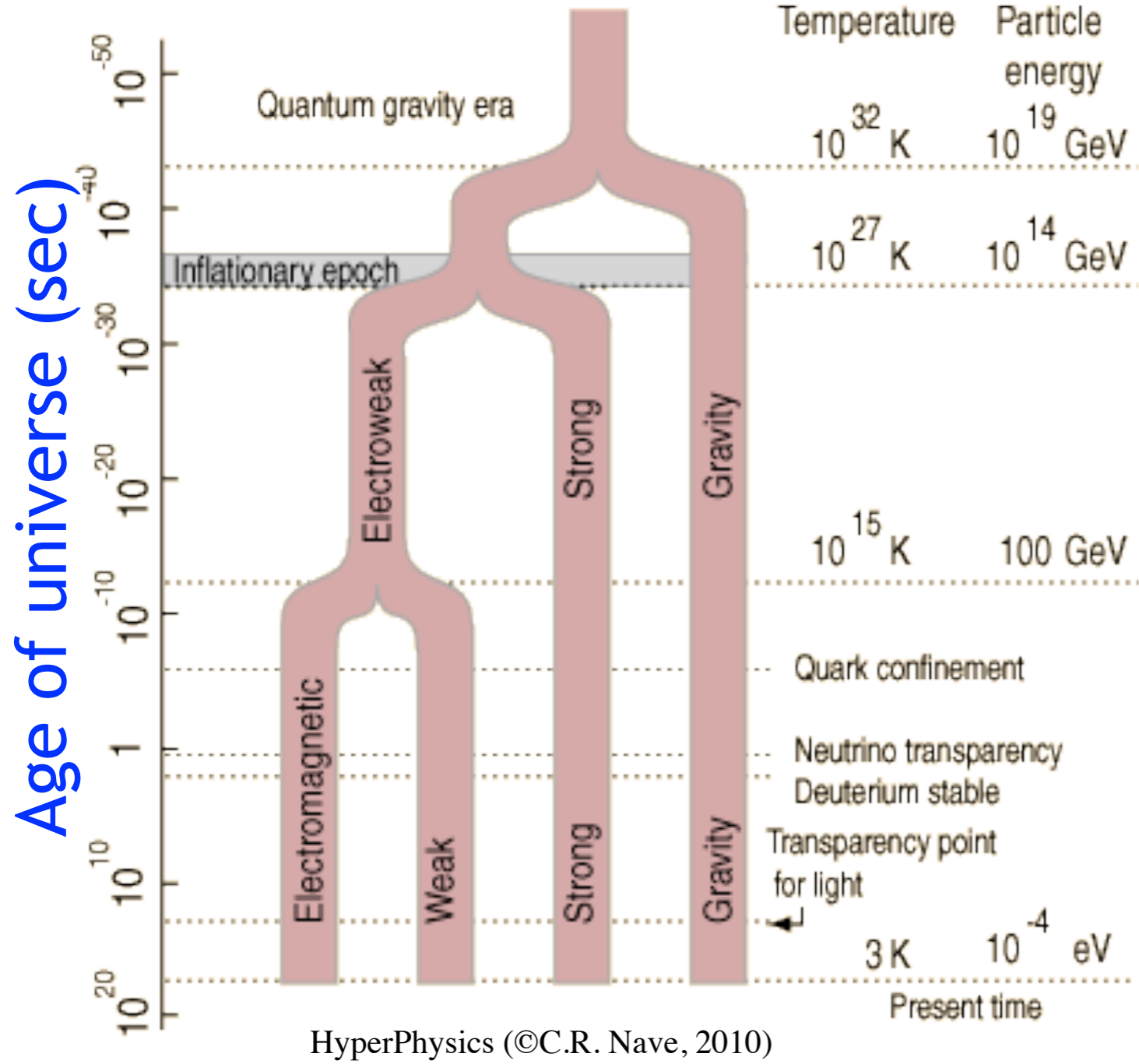

- Inflation is the only mechanism expected to create primordial B-modes
- If Inflation related to physics at GUT energy scale: $E_{\text{inf}} \sim 10^{16}$ GeV and $r > 0.01$
- $r = \frac{\text{tensor-perturbations}}{\text{scalar-perturbations}}$

$$E_{\text{inf}} = 1.06 \times 10^{16} \text{ GeV} \left(\frac{r}{.01} \right)^{1/4}$$

- Current measurements of $n_s \sim 0.97$ imply $r \sim 0.15$
- CMB currently constrains $r < 0.17$ at 95% confidence (SPT, Keisler et al. 2011)

The Polarization of the CMB: Neutrinos

A ~ 0.1 eV neutrino mass will shift the normalization of the lensed B-mode spectrum by $\sim 5\%$

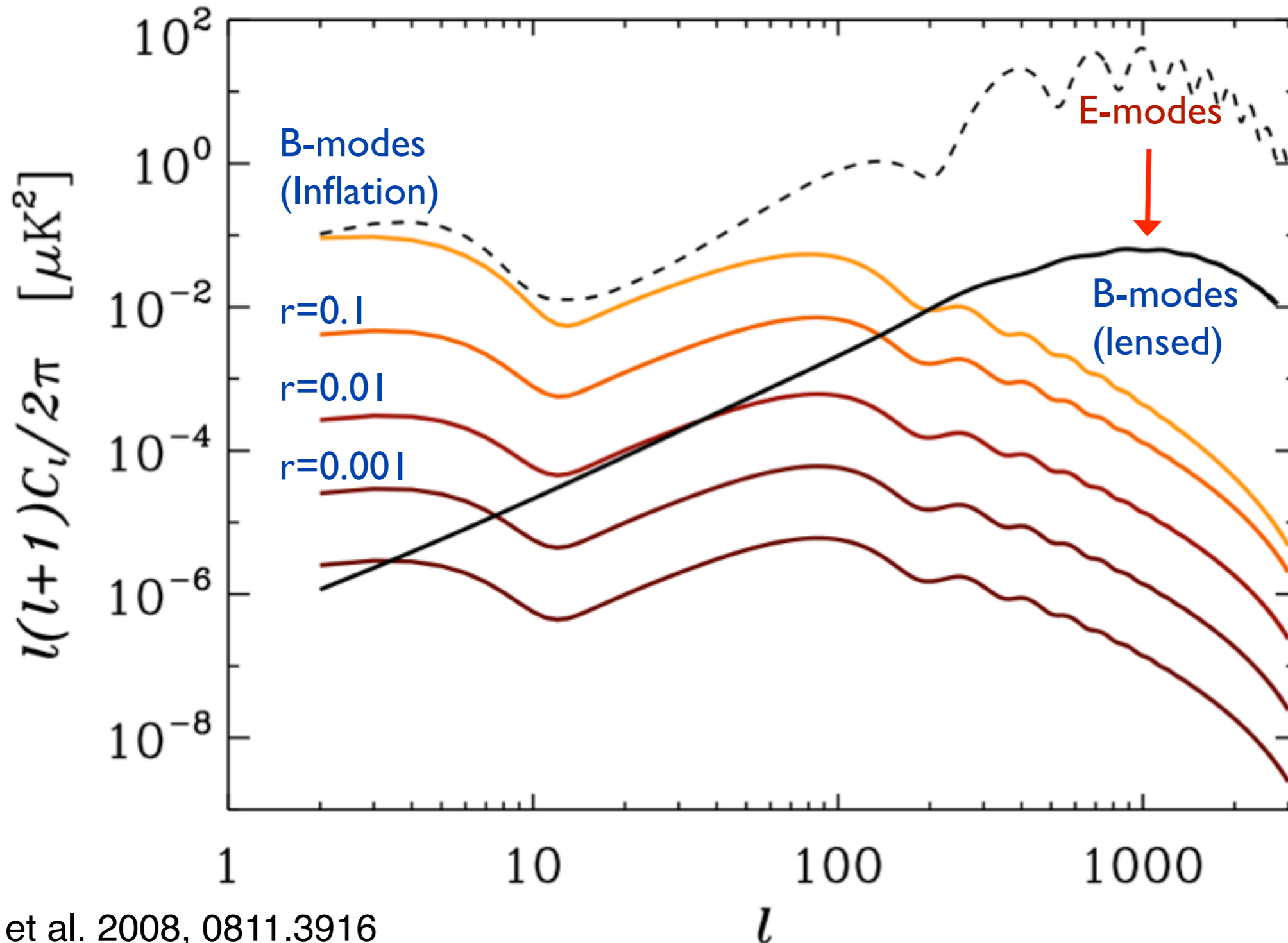

CMB Measurements so far: Closing in on Inflation!

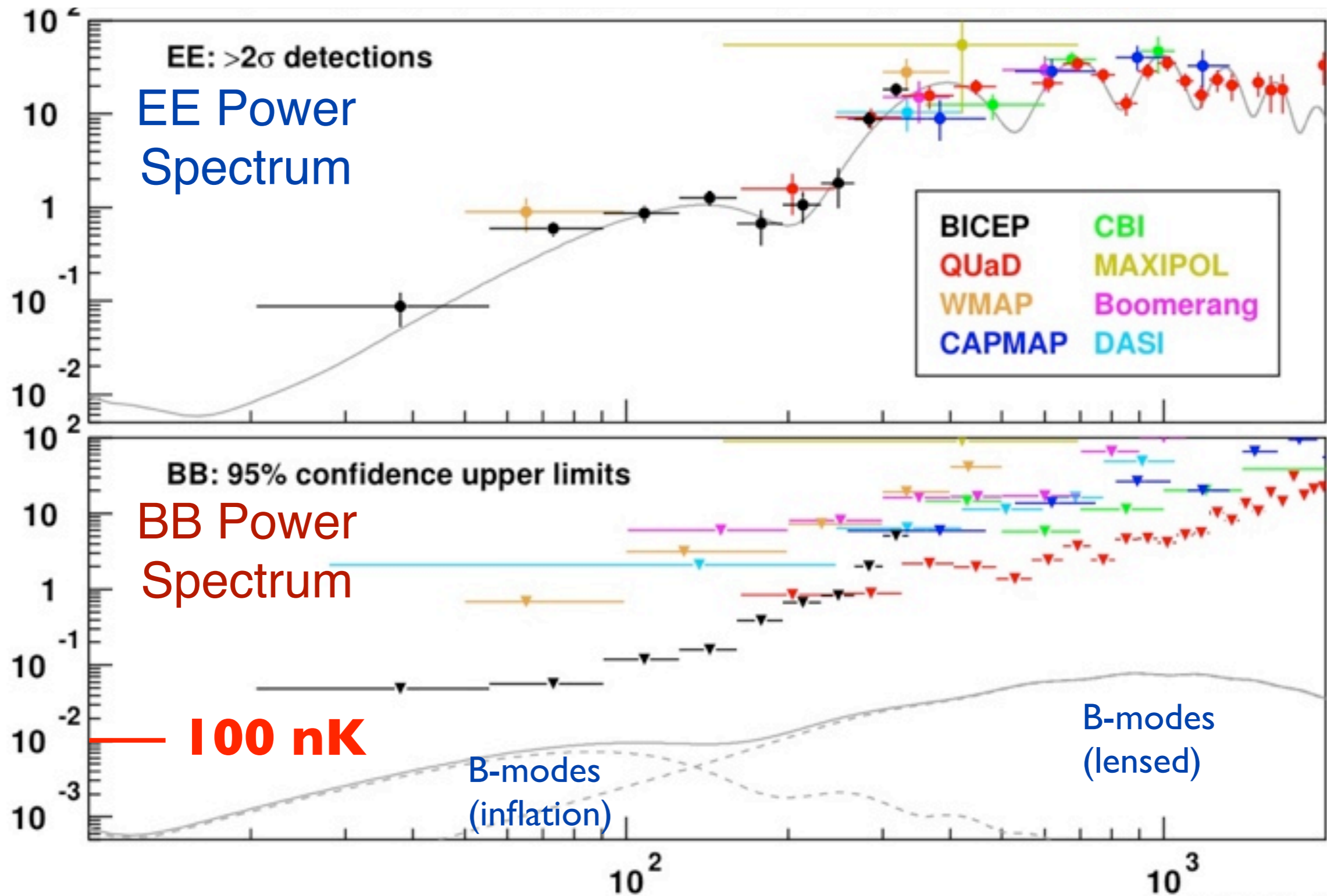

see (QUAD) Brown et al., arXiv:0906.1003 & (BICEP) Chiang et al., arXiv:0906.1181

SPTpol: Measuring the Polarization of the CMB

SPTpol:

- New polarization-sensitive camera for the SPT, first light Jan. 26, 2012!
- I just returned from 2 months at the South Pole leading the SPTpol Receiver team:
 - Liz George (UC-Berkeley), Abby Crites (U. Chicago), Jason Henning (U. Colorado)

SPTpol Receiver Deployment Team



Science from SPTpol -

“B-mode” Polarization:

1. Neutrino mass from CMB lensing
2. Energy scale of inflation

Temperature Survey:

3. Deeper cluster survey

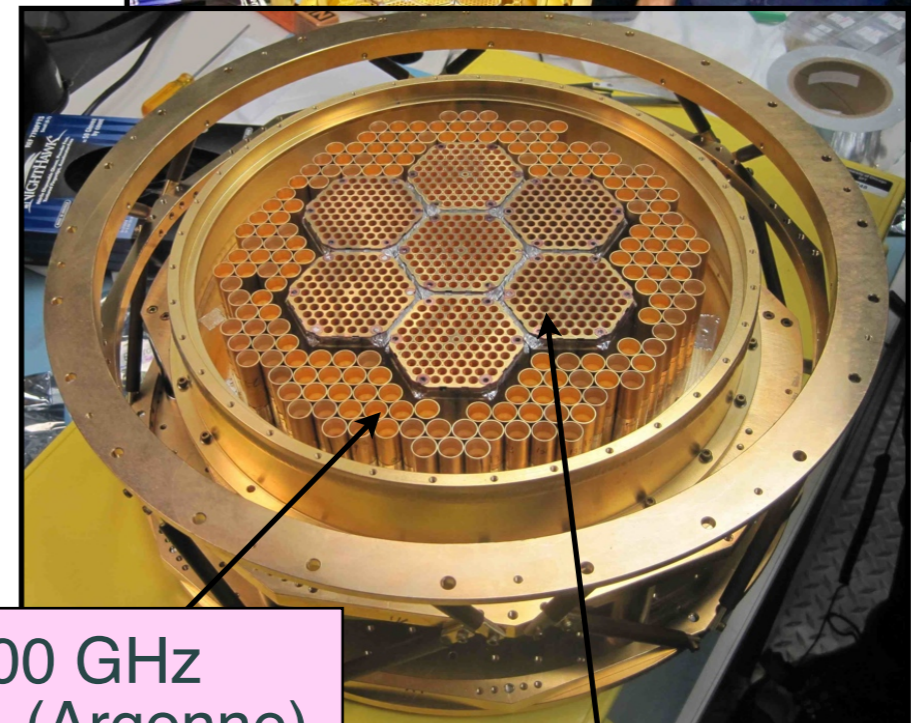

188 100 GHz pixels, (Argonne)

588 150 GHz pixels, (NIST)

SPTpol: Measuring the Polarization of the CMB

90 and 150 GHz Focal Plane:

- 90 GHz detectors made at Argonne National Labs
- 150 GHz detectors made at NIST, Boulder

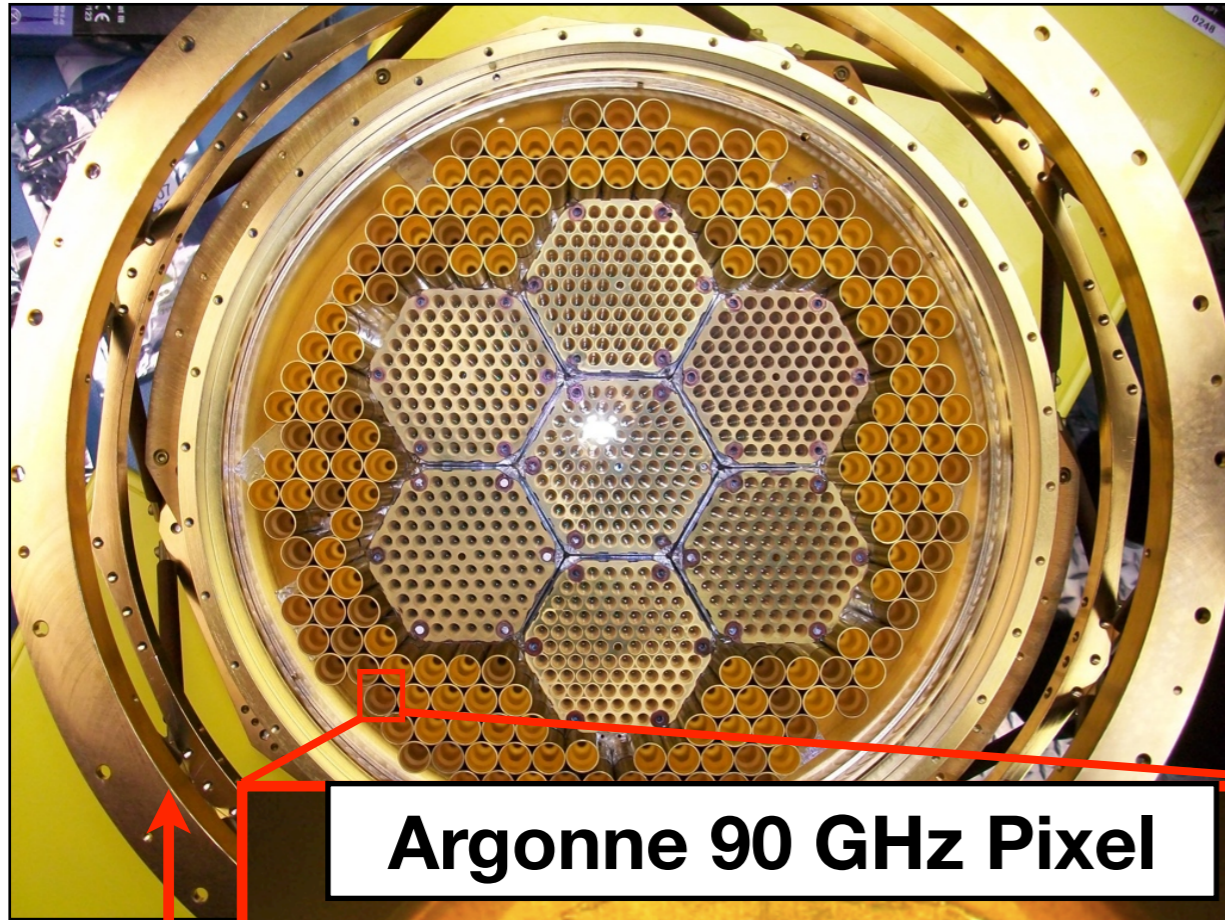

Argonne 90 GHz Pixel

6 mm

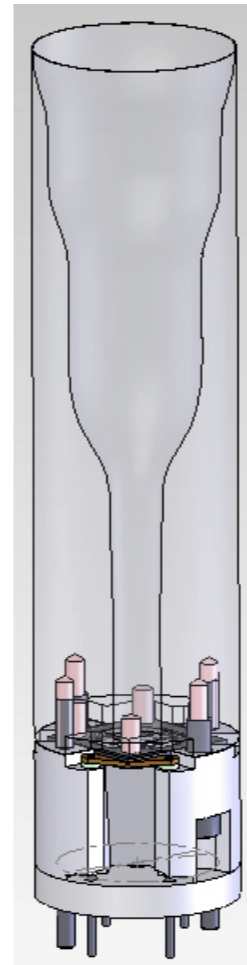
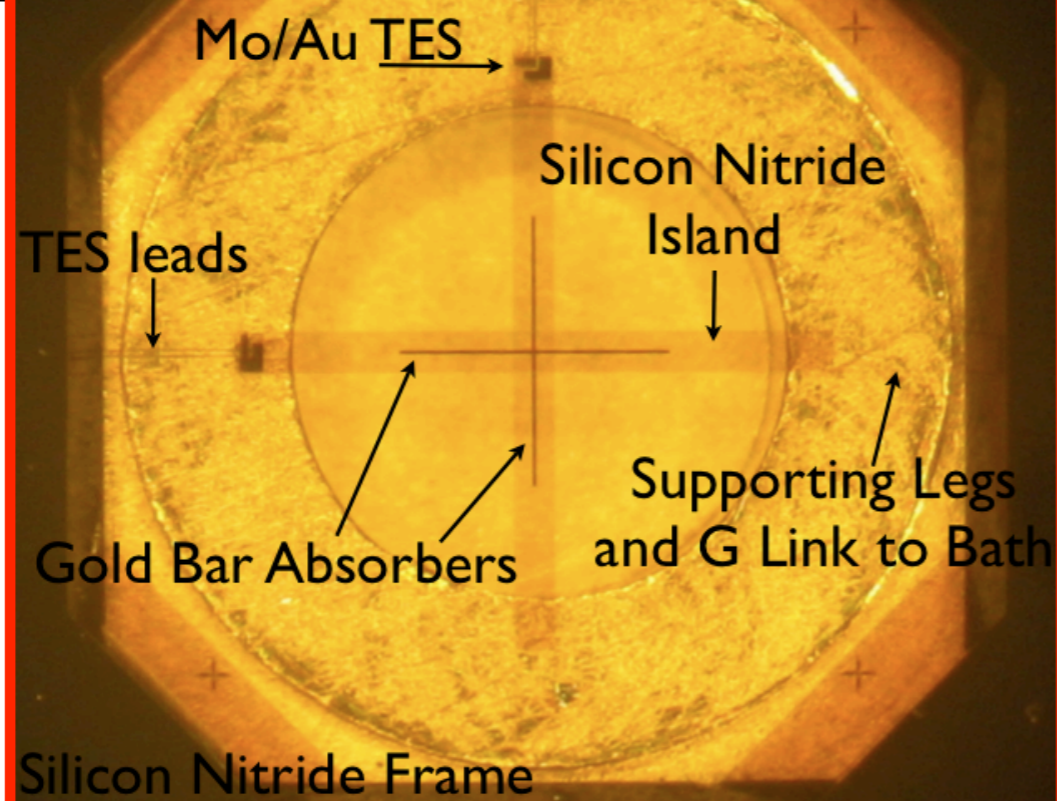

Argonne 90 GHz array

- 192x single pixels
- Individually machined contoured horns
- Crossed absorbers
- 0.50 K Mo/Au TES

SPTpol: Measuring the Polarization of the CMB

90 and 150 GHz Focal Plane:

- 90 GHz detectors made at Argonne National Labs
- 150 GHz detectors made at NIST, Boulder

NIST 150 GHz array

- 588x pixels total in 7x arrays
- Monolithic silicon platelet corrugated horn array
- Crossed OMT antenna
- Micro-strip to 0.50 K Al/Mn TES

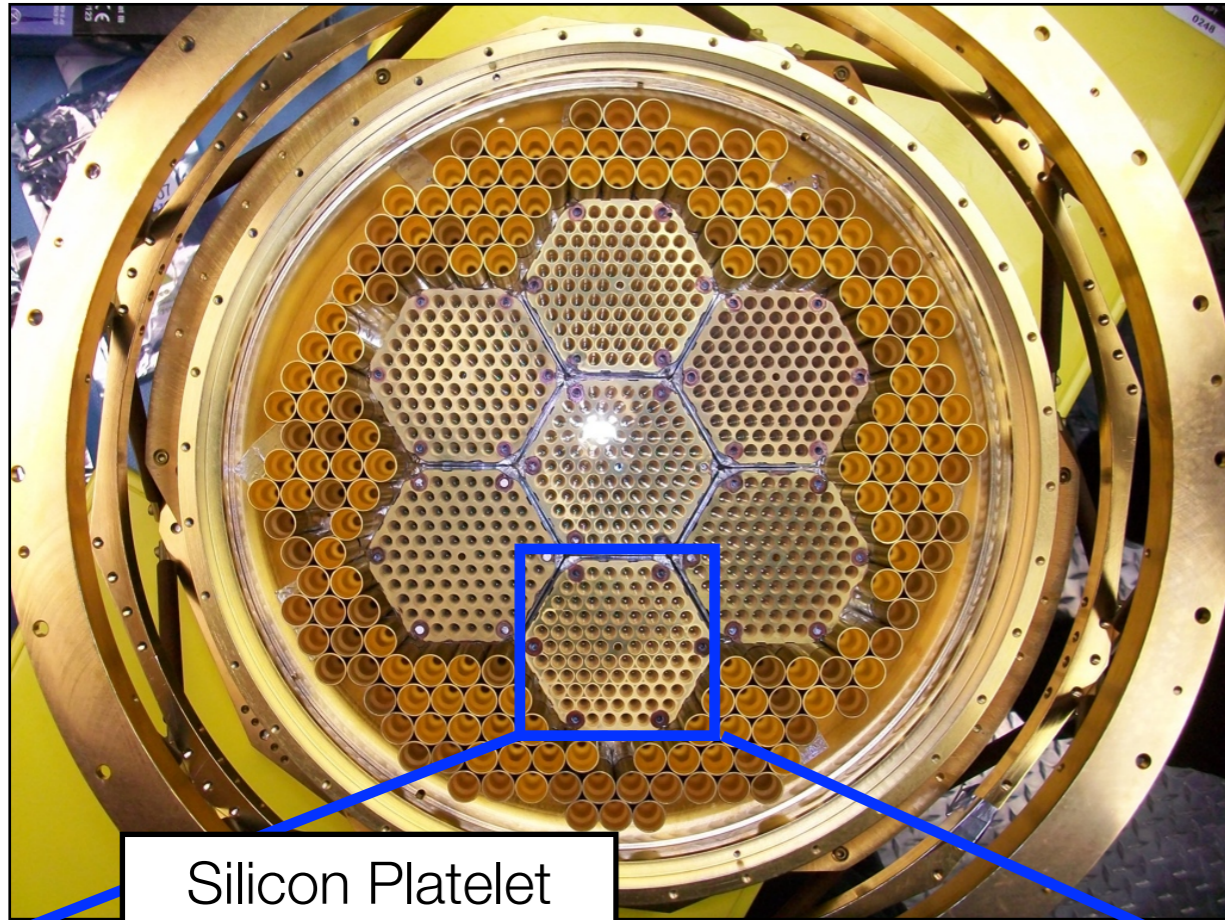

Silicon Platelet horn array

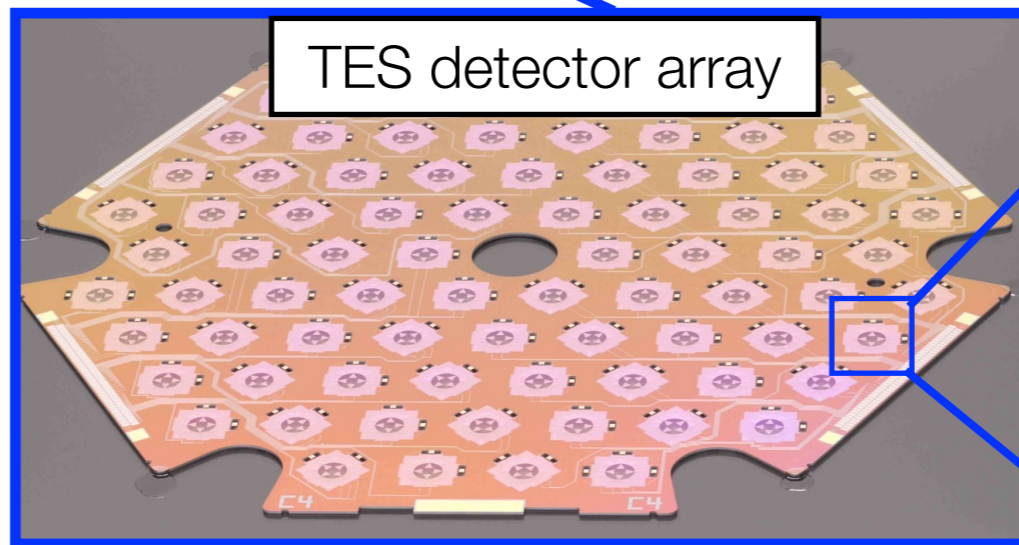
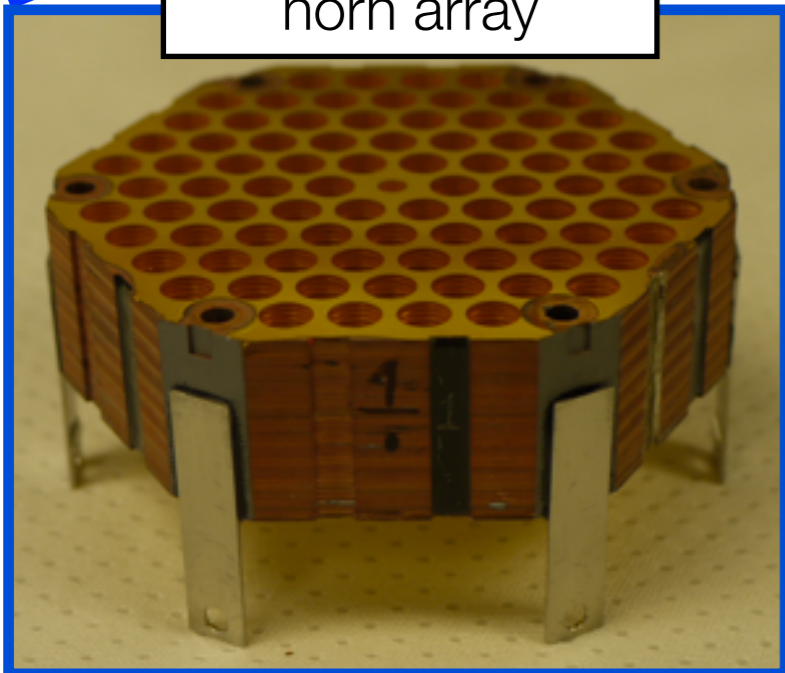

TES detector array

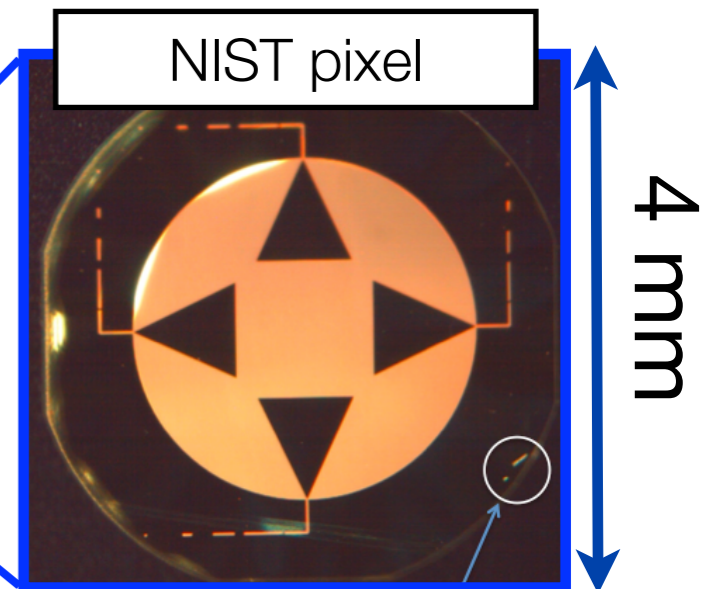

NIST pixel

4 mm

Evolution of Detector Focal Planes

2001: ACBAR
16 detectors

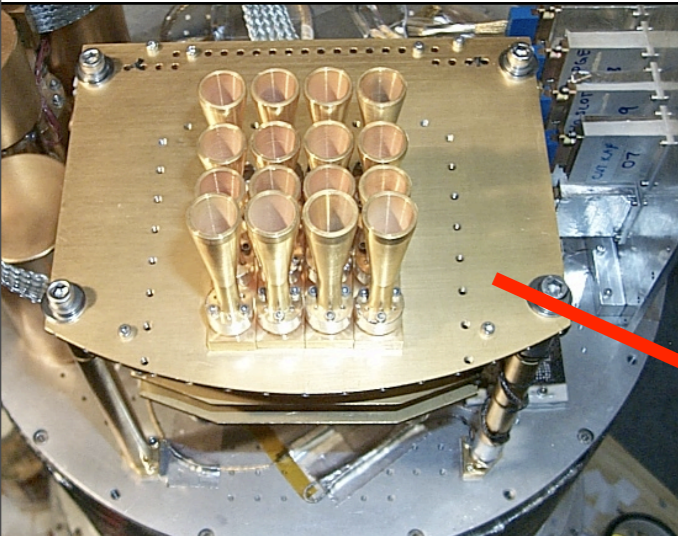

2005: BICEP
~100 detectors

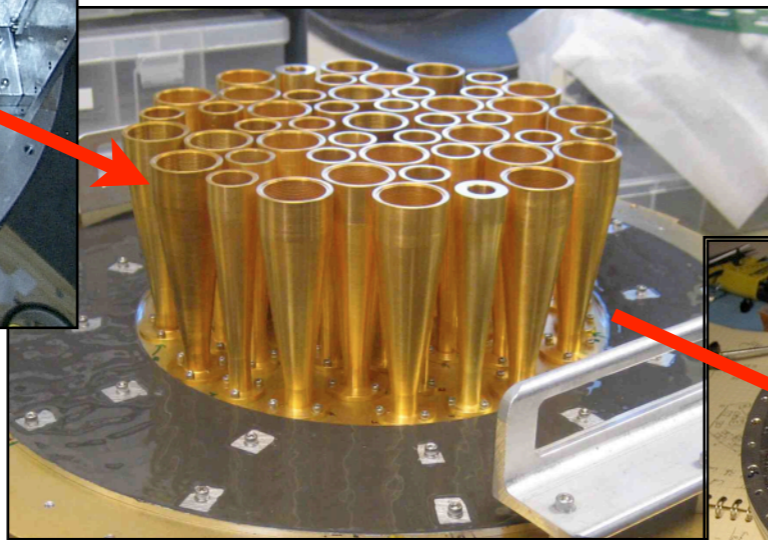

2007: SPT
960 detectors

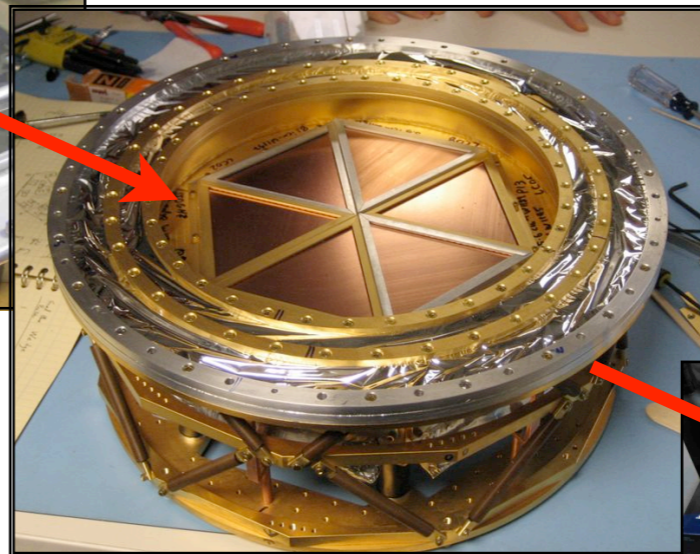

2012: SPTpol
~1600 detectors

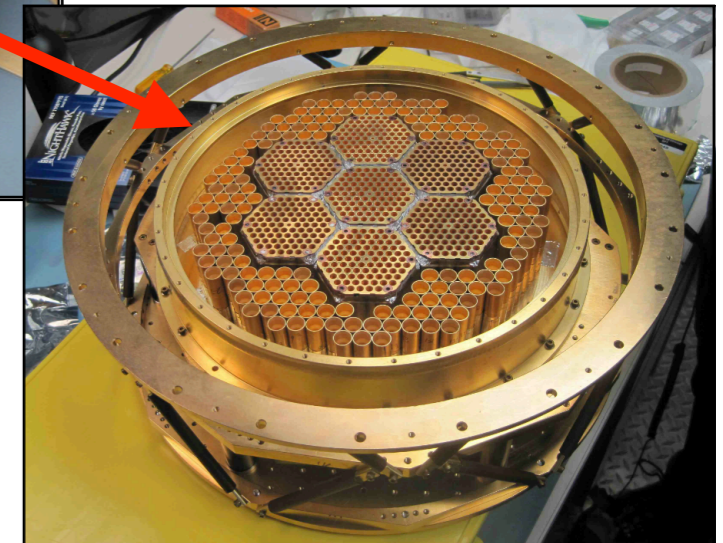

ACBAR was the first experiment to make a “background limited” detector, since then we’ve just been trying to make more of them

Evolution of Detector Focal Planes

2001: ACBAR
16 detectors

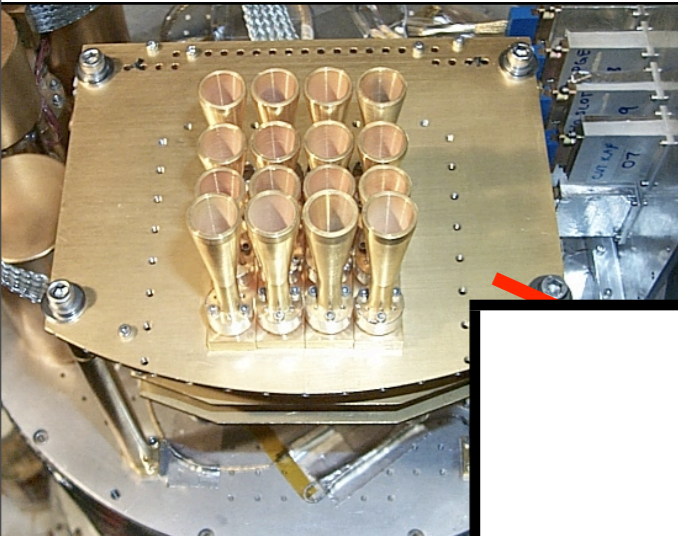

2005: BICEP
~100 detectors



2007: SPT

	NET (noise equivalent temperature) ($\mu\text{K CMB s}^{0.5}$)	SZ Mapping Speed
ACBAR	90	1
BICEP	57	5
ACT	30	9
SPT	18	30
SPTpol	~12	65

2012: SPTpol
600 detectors

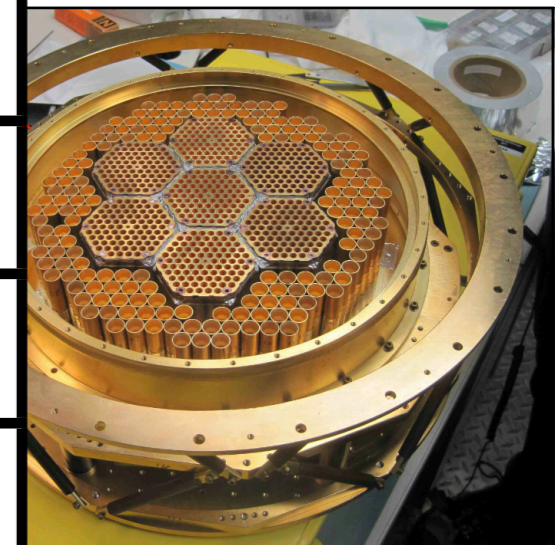

SPTpol Projected B-mode Power Spectrum

SPTpol expects to make **first-ever** detection of B-modes ~few months!

From B-mode spectrum measurements, 3-year 600 deg² SPTpol survey will constrain $r < 0.03$ at 95% confidence and $\delta(\Sigma m_\nu) = 0.10$ eV

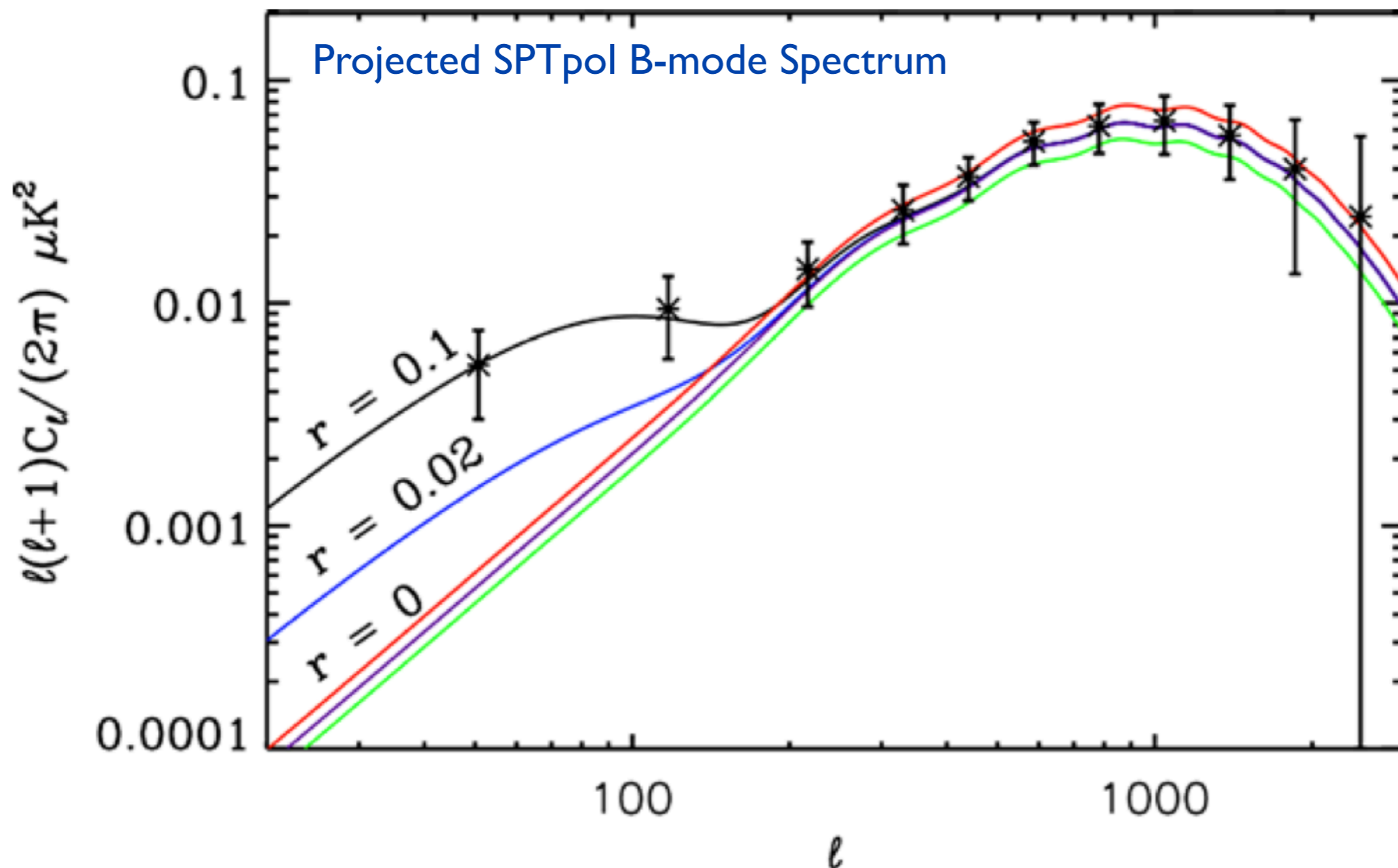

Upcoming Results!

Chandra XVP-80 / Cluster Results:

2012 - **Cosmology from XVP-80 sample:** constrain $\delta w=0.10-0.15$, measure angular diameter distance relation

2012 - **Combine XVP-80 with SPT power spectrum measurements:** constrain $\delta N_{\text{eff}}=0.2$ and $\delta(\Sigma m_\nu)\sim 0.08$ eV

2013 - **Combine with 500 cluster SPT-SZ survey and weak lensing observations:** constrain $\delta w=0.05$ from clusters-alone, growth based test of dark energy! Put first significant constraints on time evolution of w when combined with CMB+BAO+SNe

2013 - **Combine X-ray, Weak Lensing, SZ, Spitzer, Optical measurements:** study mass and redshift evolution of baryon, gas mass, and stellar mass fractions - look for “missing” baryons, study feedback and star formation history of massive clusters

2013+ - **Layout framework to combine X-ray, Weak Lensing, SZ cluster observations with DES survey.** Dark energy figure of merit of $> 100!$

Upcoming Results!

SPTpol:

2012 - **First detection of B-mode power spectrum!**

2012+ - **Combine SPTpol deep field with 100 deg² Herschel and Spitzer survey, hopefully DES.** Put constraints on $\sigma_8(z)$ out to $z \sim 4$

2013 - **First SPTpol power spectrum constraints**

2014 - **SPTpol survey finishes:** Hopefully detect inflation and neutrino mass!

2014 - **Need a new camera!**

The Polarization of the CMB:

Inflation signal could still be very small

In the next ~ 3 years several experiments (e.g. - SPTpol, BICEP2+KECK, ACTpol, Polarbear, ...) promise 95% limits on $r < \sim 0.02$

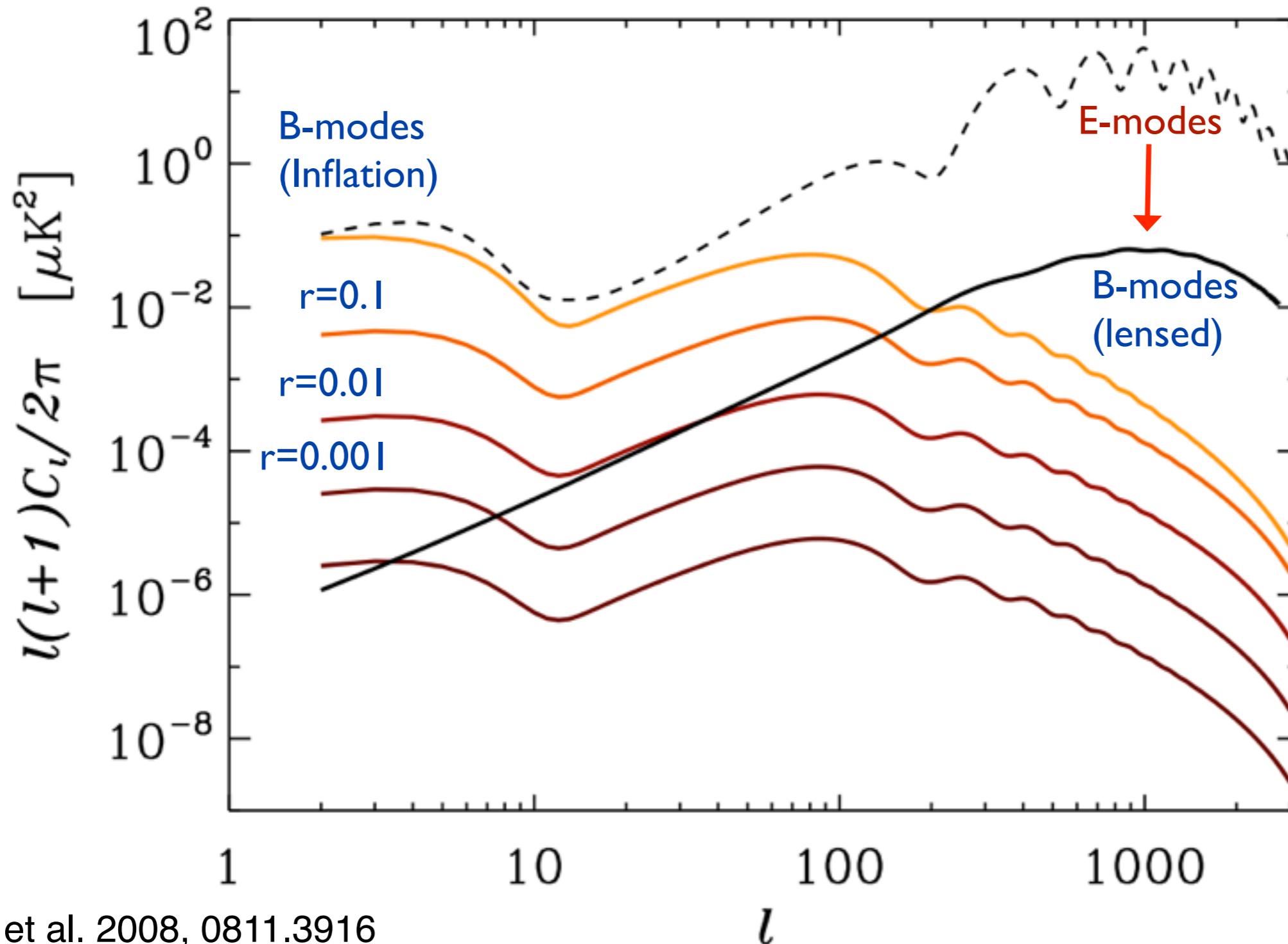

Future CMB Experiments: Definitive CMB Lensing Experiment

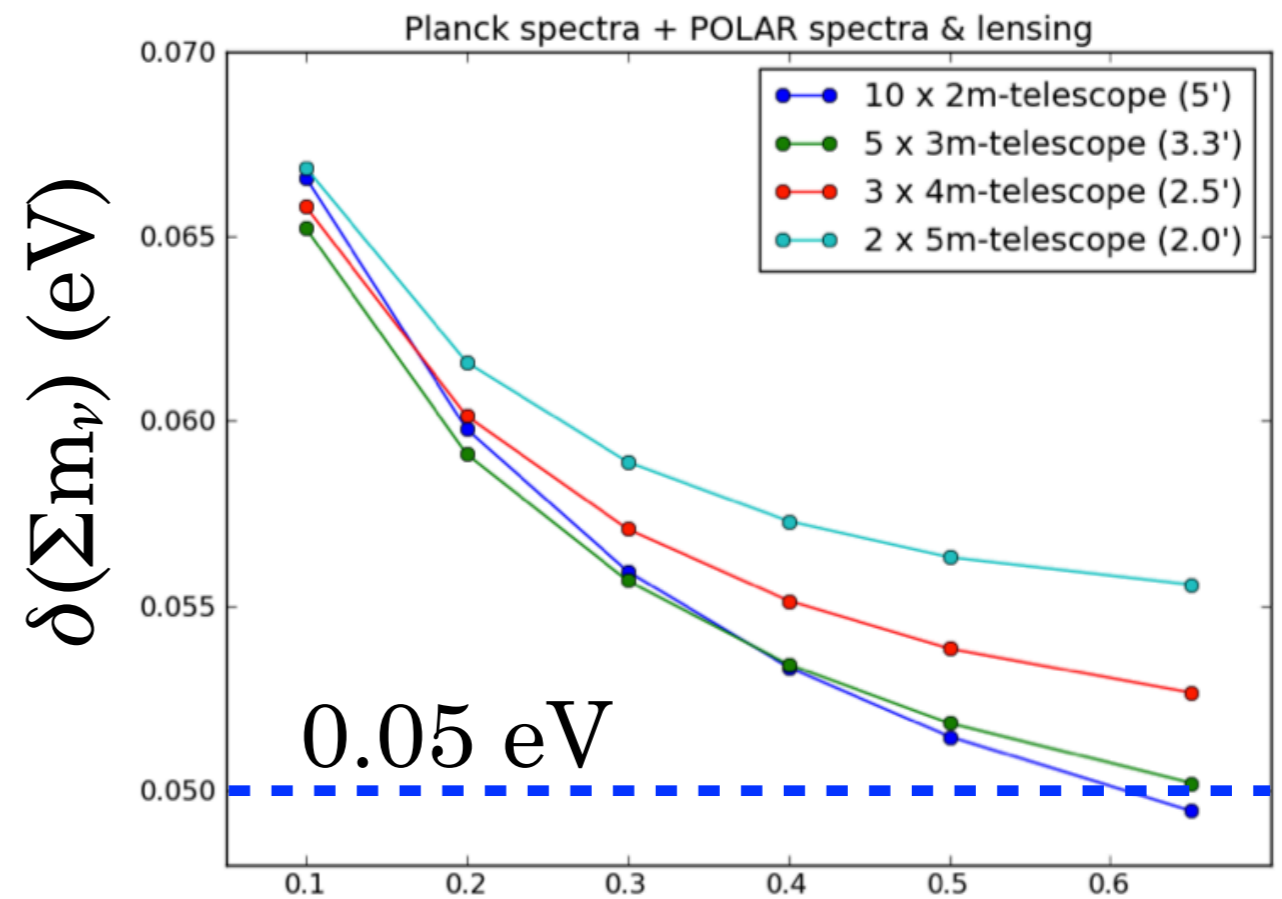
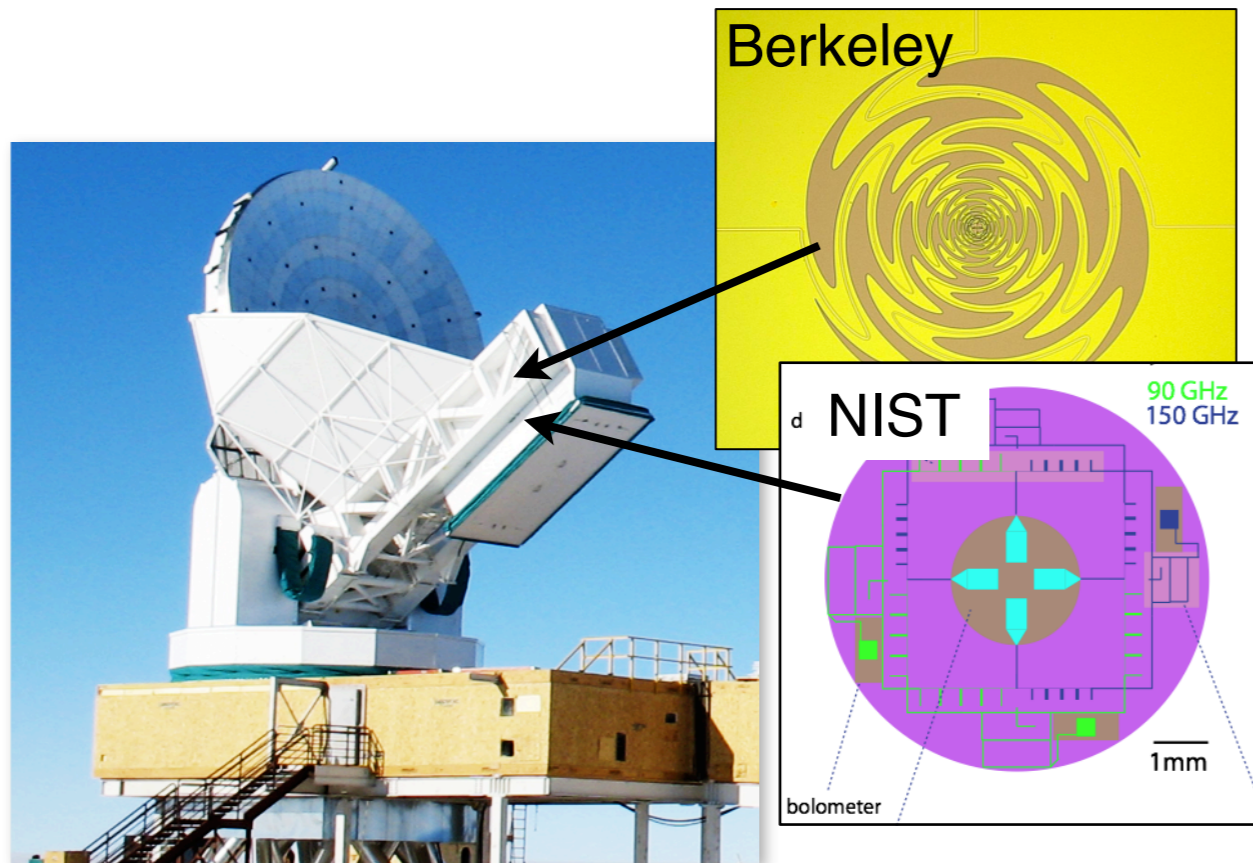

Credit: K. Wu

Re-design SPT optics for higher-throughput, and make $\sim 2,000+$ polarization sensitive multi-chroic pixels at 80-240 GHz

- Plan for “definitive” CMB lensing experiment: cover $\sim 1/2$ sky with ~ 1 uK-arcmin sensitivity

Fraction of Sky

- Survey of high- z structure growth
- CMB’s final word on: inflation ($\delta r \sim 0.003$), neutrino mass ($\delta \Sigma m_\nu \sim 0.05$ eV), curvature ($\delta \Omega_k \sim 0.003$), scalar tilt ($\delta n_s \sim 0.003$), test for early dark energy, ...

END