

Discovery of Reactor Antineutrino Disappearance at Daya Bay

*Jim Napolitano
Rensselaer Polytechnic Institute
For the Daya Bay Collaboration*



LEPP Journal Club
Cornell University
20 April 2012



Outline of this Talk

- Neutrino Mixing Phenomenology
- A Brief History of θ_{13} Measurements
- The Daya Bay Reactor Neutrino Experiment
- Future Plans *and* Next Steps for the Field

Neutrino Mixing Phenomenology

$$U_{\text{MNSP}} = \begin{bmatrix} U_{e1} & U_{e2} & U_{e3} \\ U_{\mu1} & U_{\mu2} & U_{\mu3} \\ U_{\tau1} & U_{\tau2} & U_{\tau3} \end{bmatrix} \quad \begin{array}{l} \text{Mixes “mass eigenstates”} \\ \text{with } \nu_e, \nu_\mu, \nu_\tau \end{array}$$

Neutrino Mixing Phenomenology

$$\begin{aligned}
 U_{\text{MNSP}} &= \begin{bmatrix} U_{e1} & U_{e2} & U_{e3} \\ U_{\mu1} & U_{\mu2} & U_{\mu3} \\ U_{\tau1} & U_{\tau2} & U_{\tau3} \end{bmatrix} \quad \text{Mixes "mass eigenstates" with } \nu_e, \nu_\mu, \nu_\tau \\
 &= \begin{bmatrix} 1 & 0 & 0 \\ 0 & \cos \theta_{23} & \sin \theta_{23} \\ 0 & -\sin \theta_{23} & \cos \theta_{23} \end{bmatrix} \\
 &\times \begin{bmatrix} \cos \theta_{13} & 0 & e^{-i\delta} \sin \theta_{13} \\ 0 & 1 & 0 \\ -e^{i\delta} \sin \theta_{13} & 0 & \cos \theta_{13} \end{bmatrix} \quad \left. \vphantom{\begin{bmatrix} \cos \theta_{13} & 0 & e^{-i\delta} \sin \theta_{13} \\ 0 & 1 & 0 \\ -e^{i\delta} \sin \theta_{13} & 0 & \cos \theta_{13} \end{bmatrix}} \right\} \text{CP-violating phase } \delta \text{ is married to } \theta_{13} \\
 &\times \begin{bmatrix} \cos \theta_{12} & \sin \theta_{12} & 0 \\ -\sin \theta_{12} & \cos \theta_{12} & 0 \\ 0 & 0 & 1 \end{bmatrix}
 \end{aligned}$$

Simple-Minded Neutrino Oscillations

See the PDG “Neutrino Mixing” review for the real deal

$$\begin{aligned} P(\nu_a \rightarrow \nu_b) &= |\langle \nu_b(t) | \nu_a(t) \rangle|^2 = |\langle \nu_b | e^{-iHt} | \nu_a \rangle|^2 \\ &= \left| \sum_{i,j} \langle \nu_j | U_{bj}^\dagger e^{-iHt} U_{ai} | \nu_i \rangle \right|^2 = \left| \sum_{i,j} e^{-iE_i t} \langle \nu_j | U_{bj}^\dagger U_{ai} | \nu_i \rangle \right|^2 \end{aligned}$$

Let the neutrinos travel a distance L , and assume that ν_a is produced in a state of definite momentum. Then...

- $t = L/c$
- $E_i = (p^2 + m_i^2)^{1/2} = p + m_i^2/2p$

For example $\nu_e \rightarrow \nu_e$ gives...

$$P_{ee} \approx 1 - \sin^2 2\theta_{13} \sin^2\left(\frac{\Delta m_{31}^2 L}{4E_\nu}\right) - \cos^4 \theta_{13} \sin^2 2\theta_{12} \sin^2\left(\frac{\Delta m_{21}^2 L}{4E_\nu}\right)$$

Choose sensitivity to θ_{12} (or θ_{13}) by adjusting L for a given E_ν , depending on $\Delta m_{21}^2 \equiv m_2^2 - m_1^2$ (or Δm_{31}^2).

(We will come back to this formula when we discuss disappearance of reactor electron antineutrinos.)

It looks easy, but neutrino oscillations was only in the textbooks, until...

The Solar Neutrino Problem

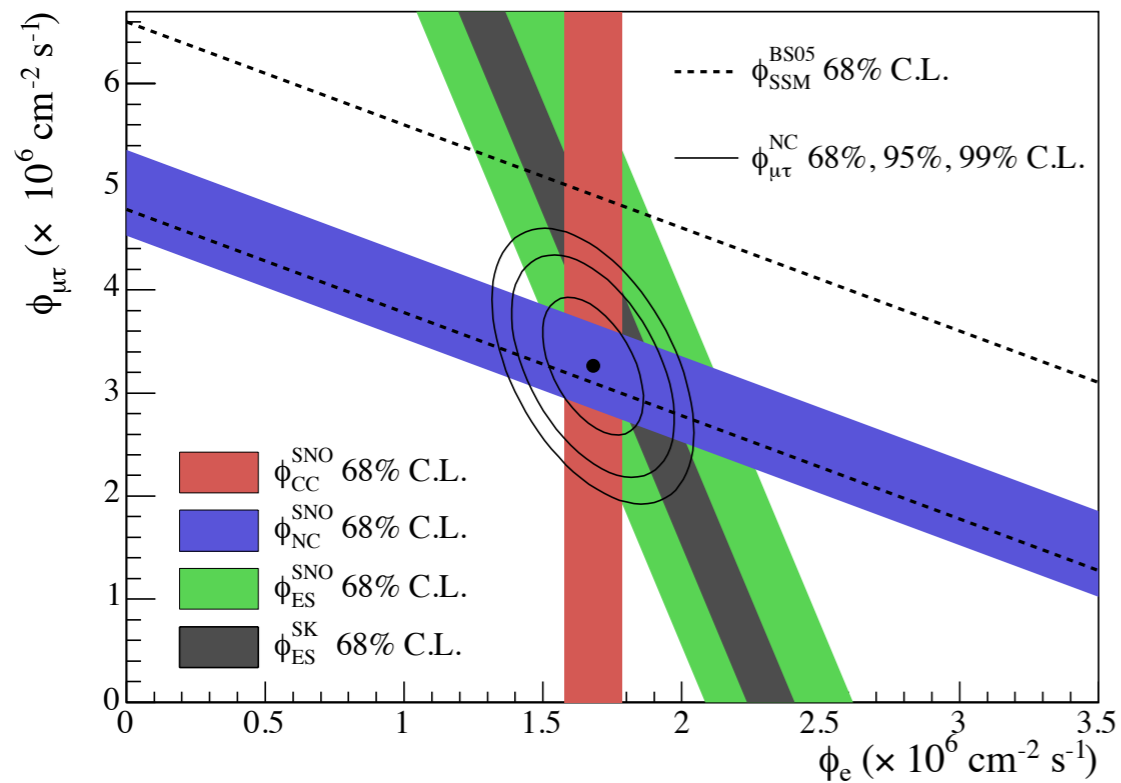
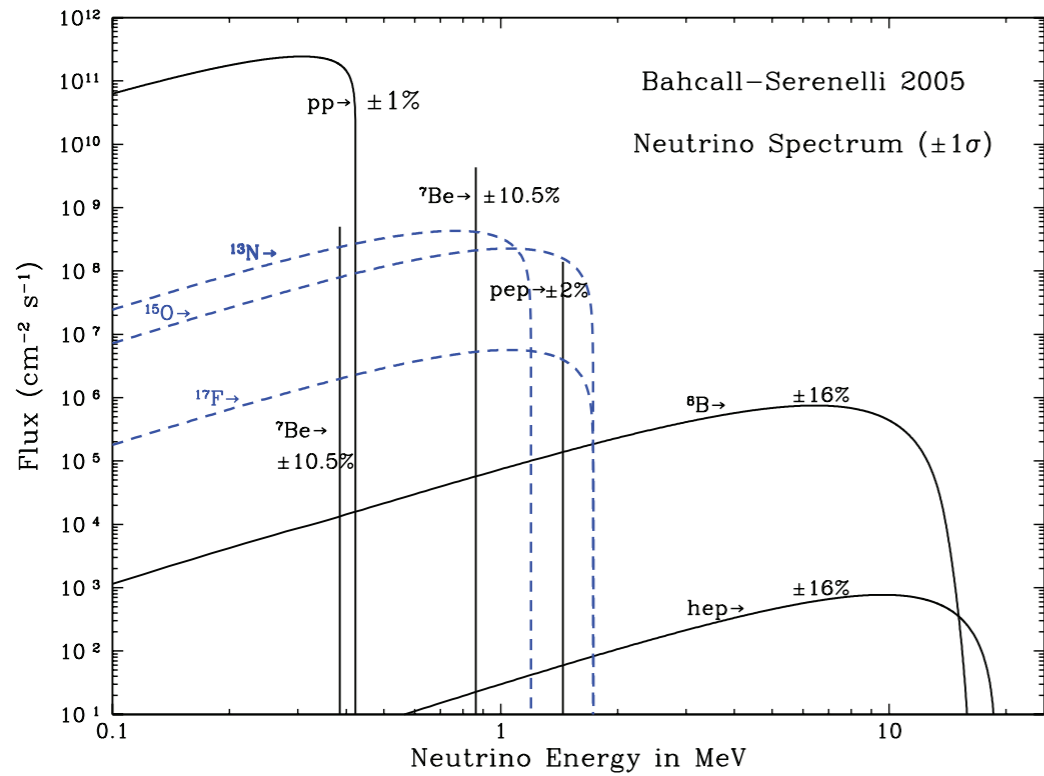

The Atmospheric Neutrino Anomaly

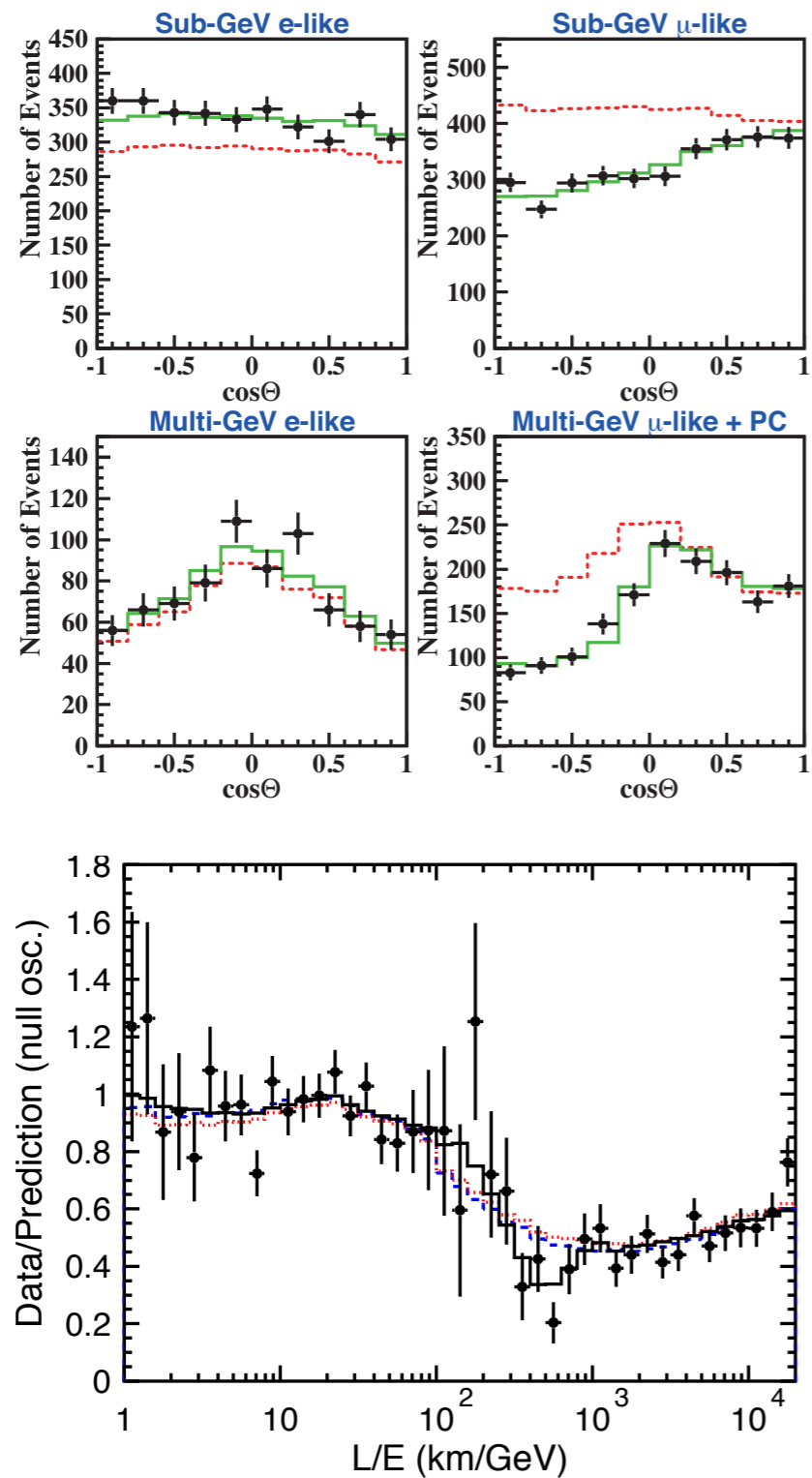

The Atmospheric Neutrino Anomaly

MINOS

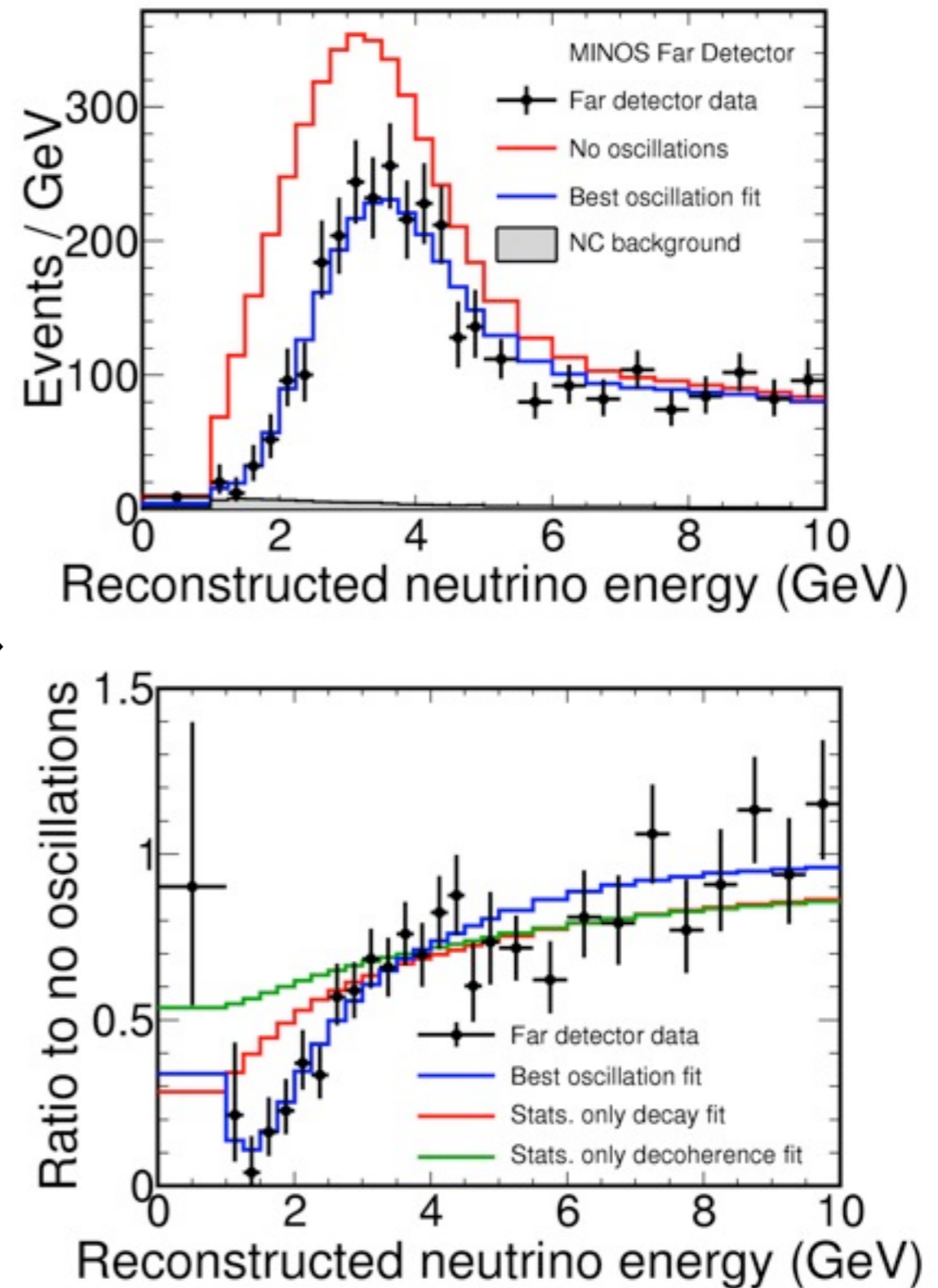
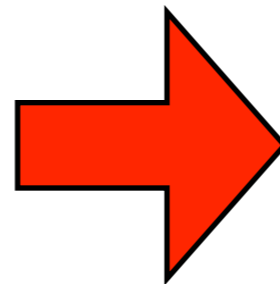
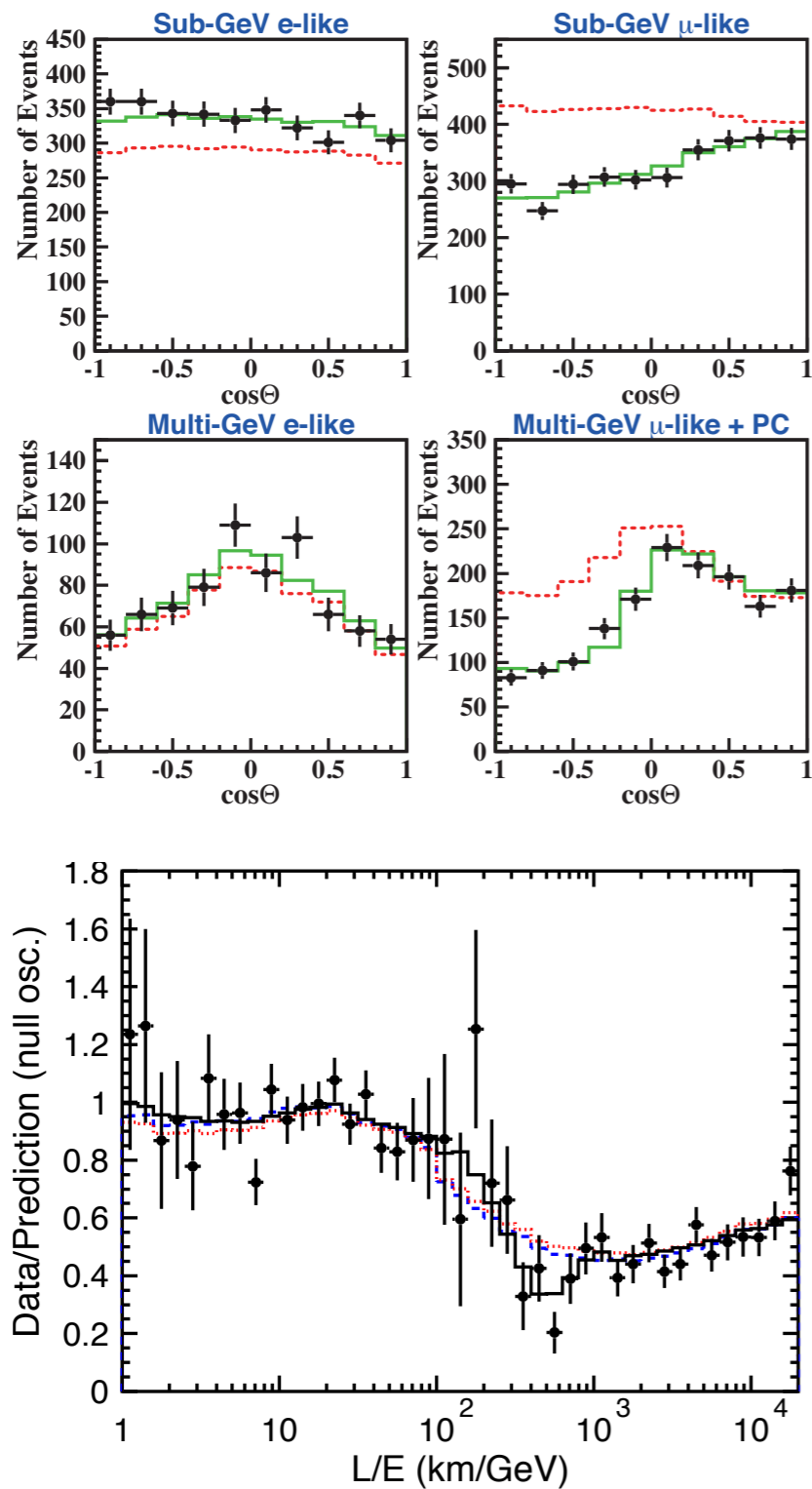

The Mixing Matrix ~One Year Ago

$$\begin{aligned}
 U_{\text{MNSP}} &= \begin{bmatrix} U_{e1} & U_{e2} & U_{e3} \\ U_{\mu1} & U_{\mu2} & U_{\mu3} \\ U_{\tau1} & U_{\tau2} & U_{\tau3} \end{bmatrix} \\
 &= \begin{bmatrix} 1 & 0 & 0 \\ 0 & \cos \theta_{23} & \sin \theta_{23} \\ 0 & -\sin \theta_{23} & \cos \theta_{23} \end{bmatrix} \\
 &\times \begin{bmatrix} \cos \theta_{13} & 0 & e^{-i\delta} \sin \theta_{13} \\ 0 & 1 & 0 \\ -e^{i\delta} \sin \theta_{13} & 0 & \cos \theta_{13} \end{bmatrix} \\
 &\times \begin{bmatrix} \cos \theta_{12} & \sin \theta_{12} & 0 \\ -\sin \theta_{12} & \cos \theta_{12} & 0 \\ 0 & 0 & 1 \end{bmatrix}
 \end{aligned}$$

PDG 2010: “The pattern of neutrino mixing is drastically different from the pattern of quark mixing.”

$$\Delta m_{32}^2 = 2.40 \times 10^{-3} \text{ eV}^2$$

$$0.36 \leq \sin^2 \theta_{23} \leq 0.67$$

$$\Delta m_{31}^2 = \Delta m_{32}^2 + \Delta m_{21}^2$$

$$\approx \Delta m_{32}^2$$

$$\sin^2 \theta_{13} < 0.035 \star$$

$$\Delta m_{21}^2 = 7.65 \times 10^{-5} \text{ eV}^2$$

$$0.25 \leq \sin^2 \theta_{12} \leq 0.37$$

A Recent History of θ_{13}

- Chooz reactor experiment (2003) has best upper limit from a direct measurement.
- Hints of nonzero θ_{13} from direct comparison of solar neutrinos and KamLAND (2008).
- Accelerator appearance experiment T2K (2011) observes six events!
- “Double Chooz” (2011) publishes spectrum from single detector, consistent with T2K.

Search for neutrino oscillations on a long base-line at the CHOOZ nuclear power station

Eur. Phys. J. C 27, 331–374 (2003)

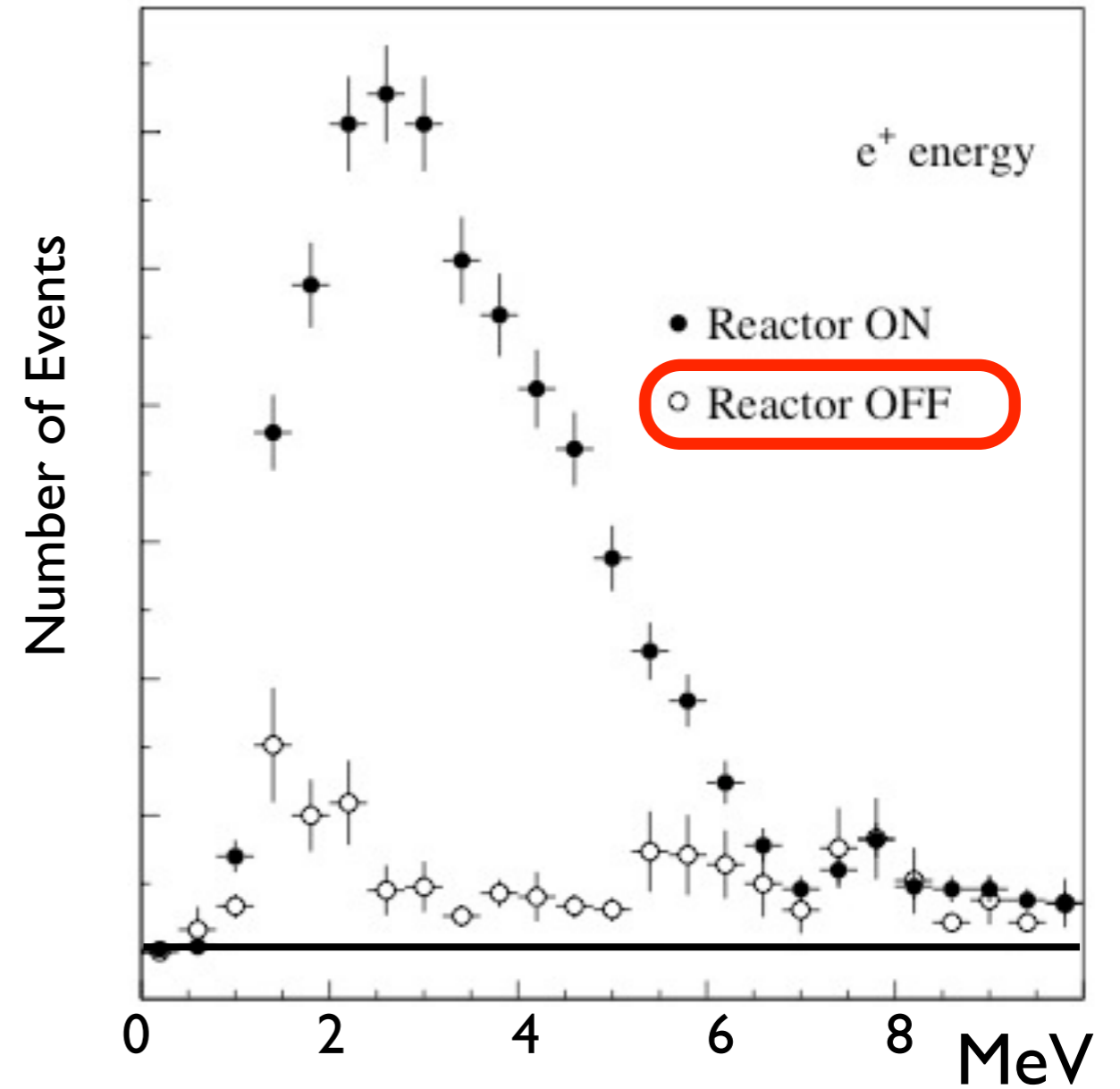
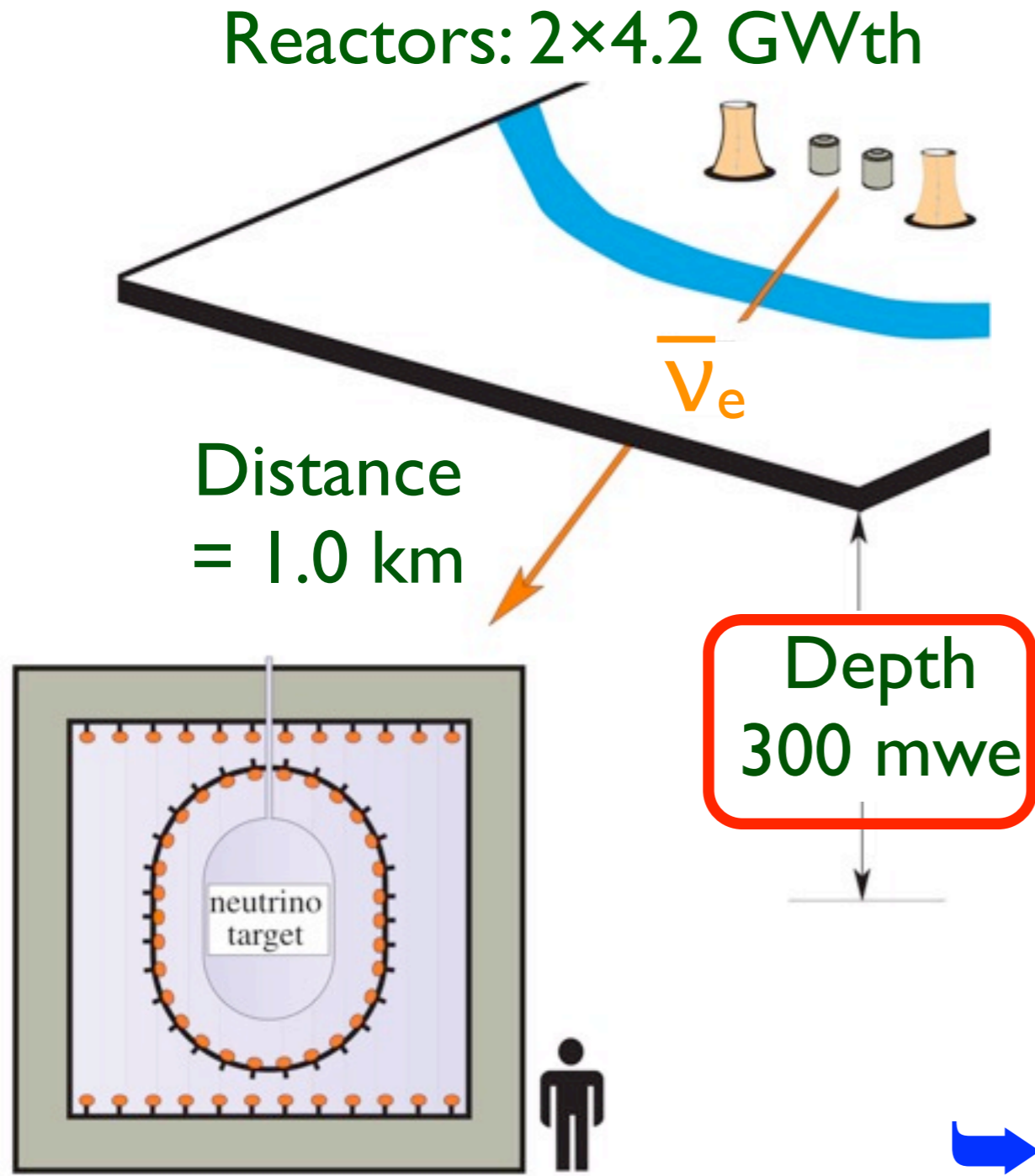

→ $\sin^2 2\theta_{13} < 0.15$ (90% CL)

Hints of $\theta_{13} > 0$ from Global Neutrino Data Analysis

G. L. Fogli,^{1,2} E. Lisi,² A. Marrone,^{1,2} A. Palazzo,³ and A. M. Rotunno^{1,2}

¹*Dipartimento di Fisica, Università di Bari, Via Amendola 173, 70126, Bari, Italy*

²*Istituto Nazionale di Fisica Nucleare (INFN), Sezione di Bari, Via Orabona 4, 70126 Bari, Italy*

³*AHEP Group, Institut de Física Corpuscular, CSIC/Universitat de València, Edifici Instituts d'Investigació, Apt. 22085, 46071 València, Spain*

(Received 17 June 2008; published 30 September 2008)

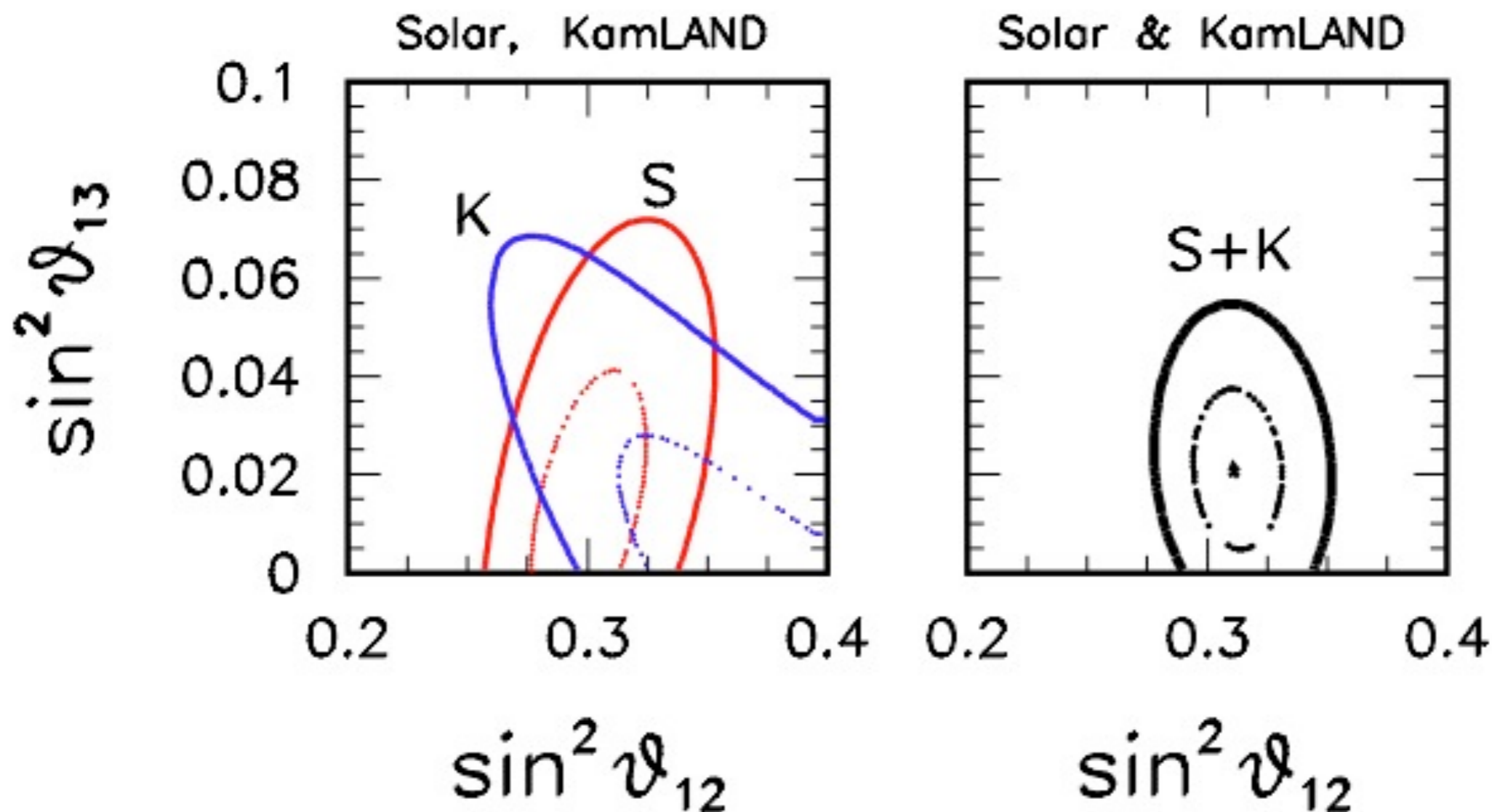

Indication of Electron Neutrino Appearance from an Accelerator-Produced Off-Axis Muon Neutrino Beam

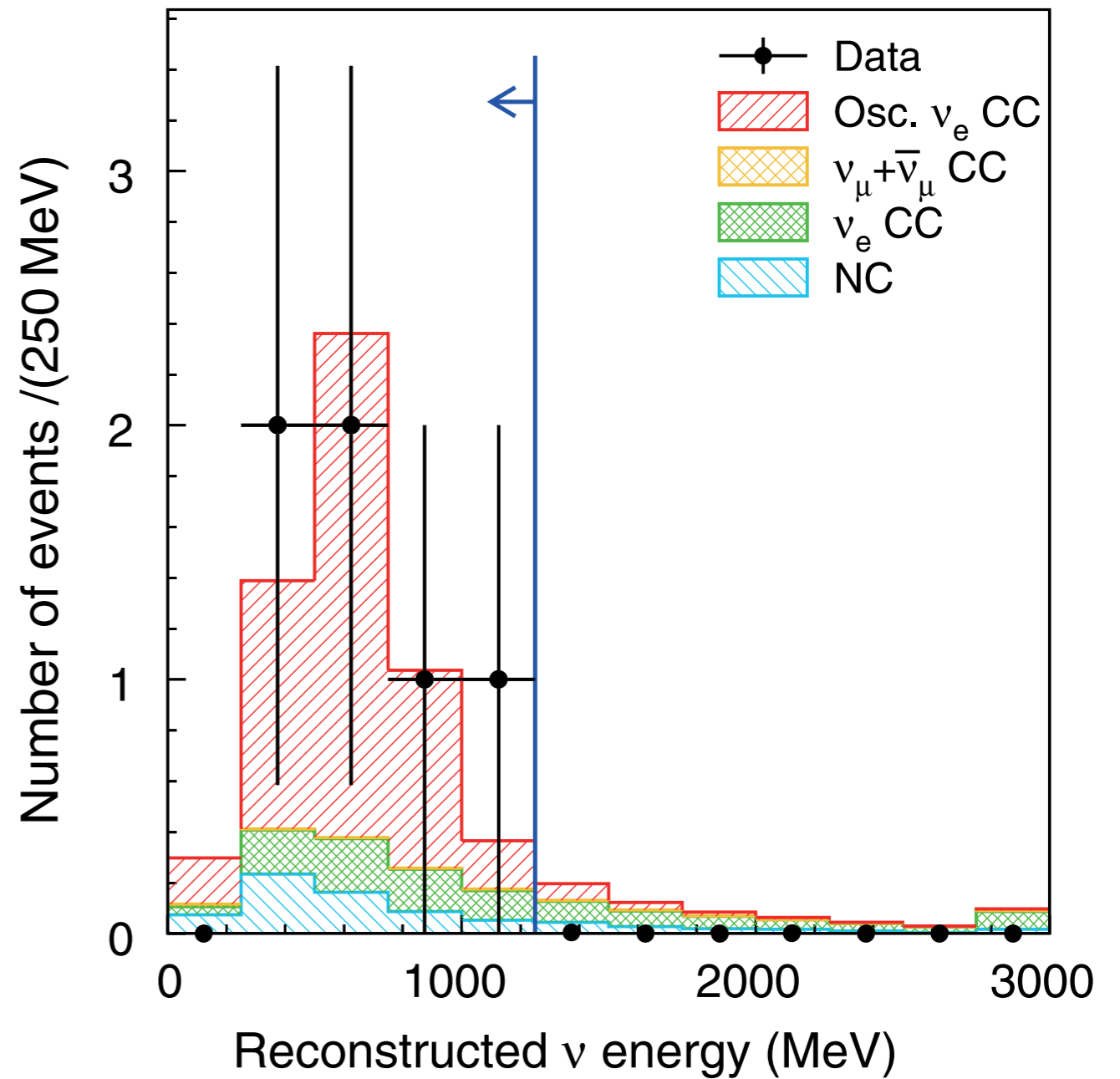
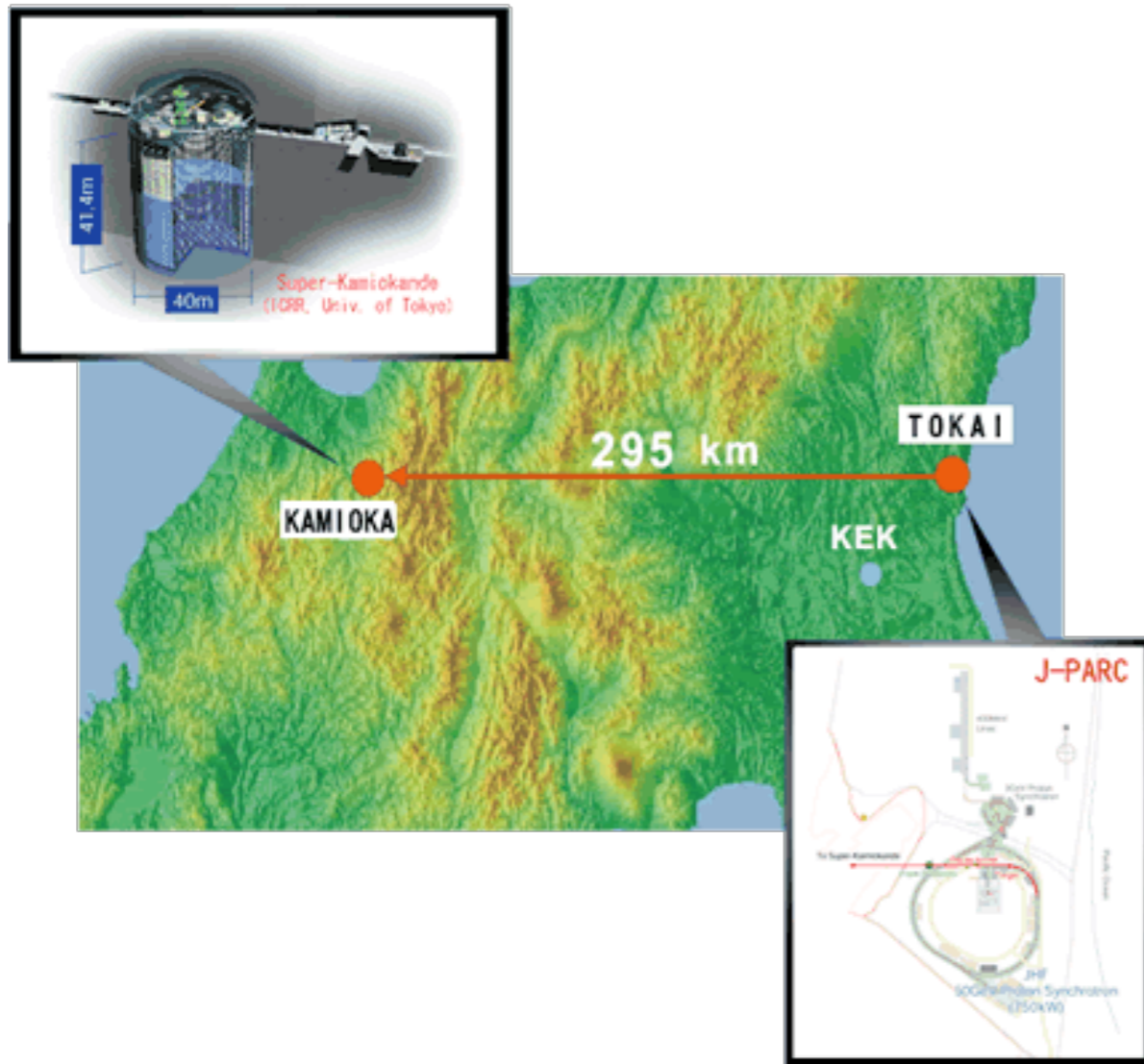

Indication of Reactor $\bar{\nu}_e$ Disappearance in the Double Chooz Experiment

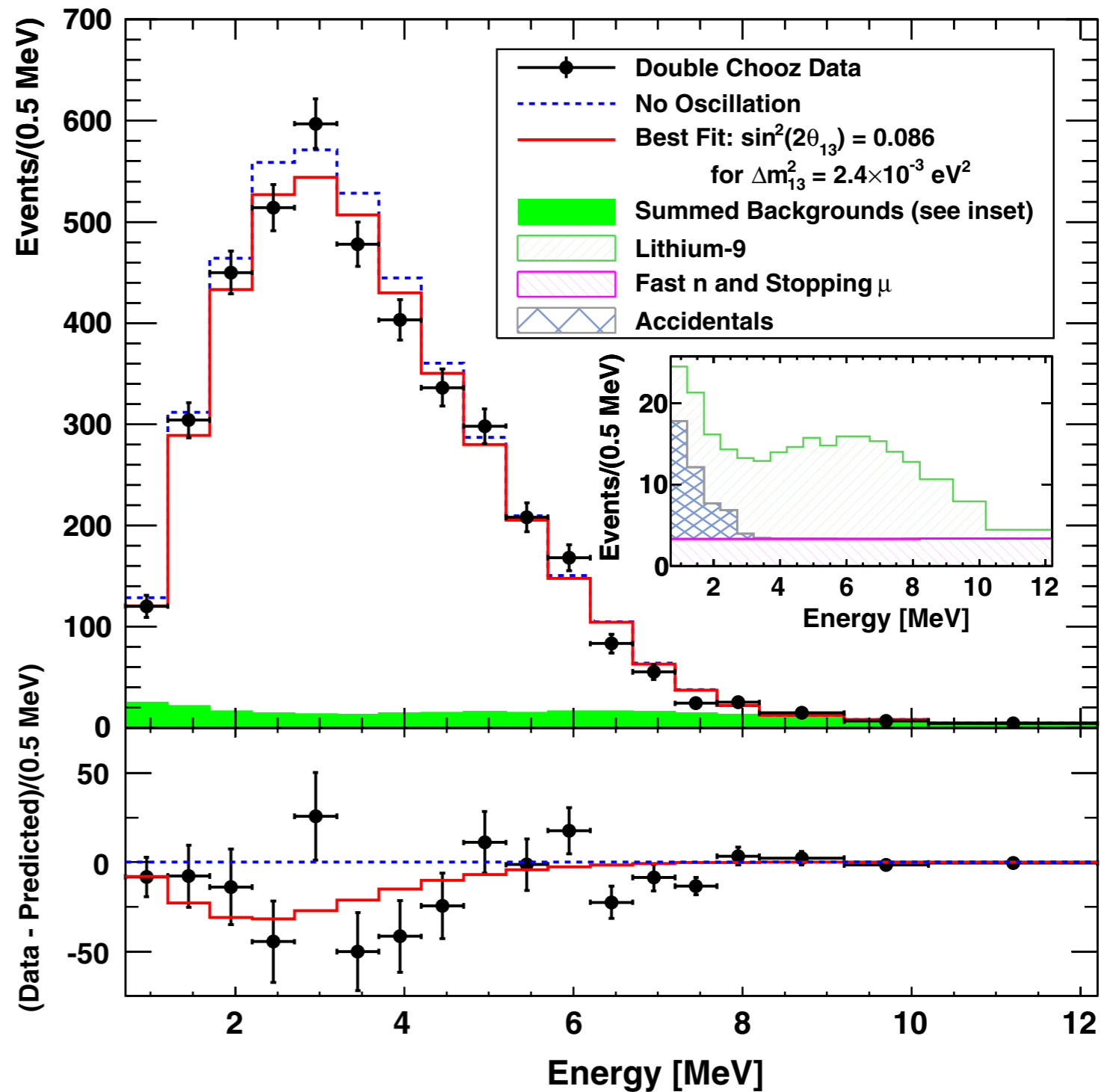
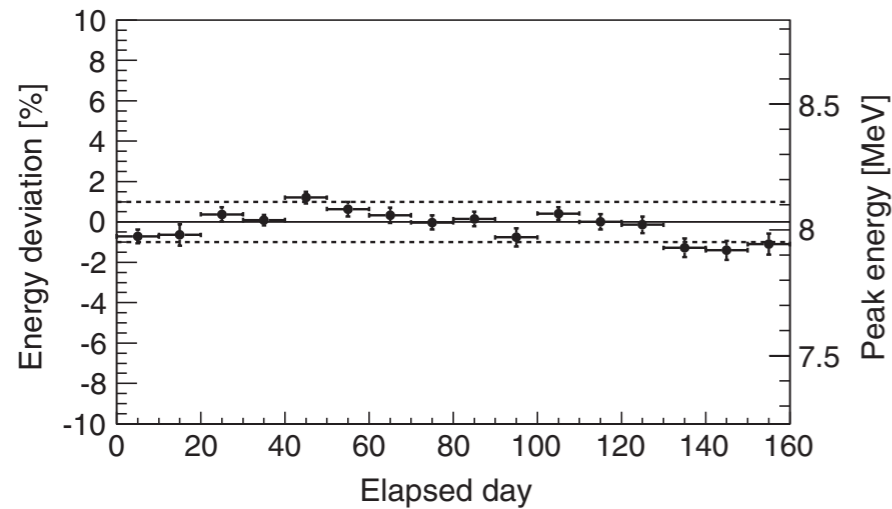
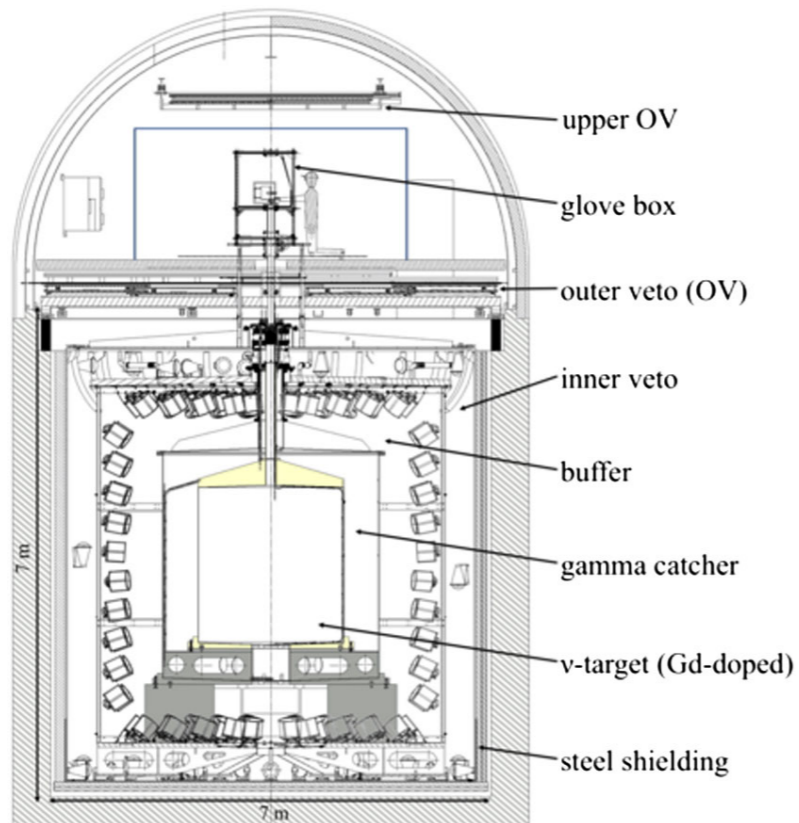

Status of θ_{13} Six Weeks Ago

$$\sin^2 2\theta_{13}$$

Best Value

0.081

95% CL

0.023-0.16

ArXiv:1111.3330, Machado, Minakata,
Nunokawa, Zukanovich, Funcal

(Normal Hierarchy)

The Daya Bay Experiment



- Global collaboration: Asia, US, Europe
- 17GW power reactor at Daya Bay, China
- Functionally identical detectors far and near
- Detectors in tunnels under mountains
- Design sensitivity better than one percent

Detector comparison: [arXiv:1202.6181](https://arxiv.org/abs/1202.6181) (for NIM)

Determination of θ_{13} : [arXiv:1203.1669](https://arxiv.org/abs/1203.1669) (accepted by PRL)

One of Three Competing Experiments

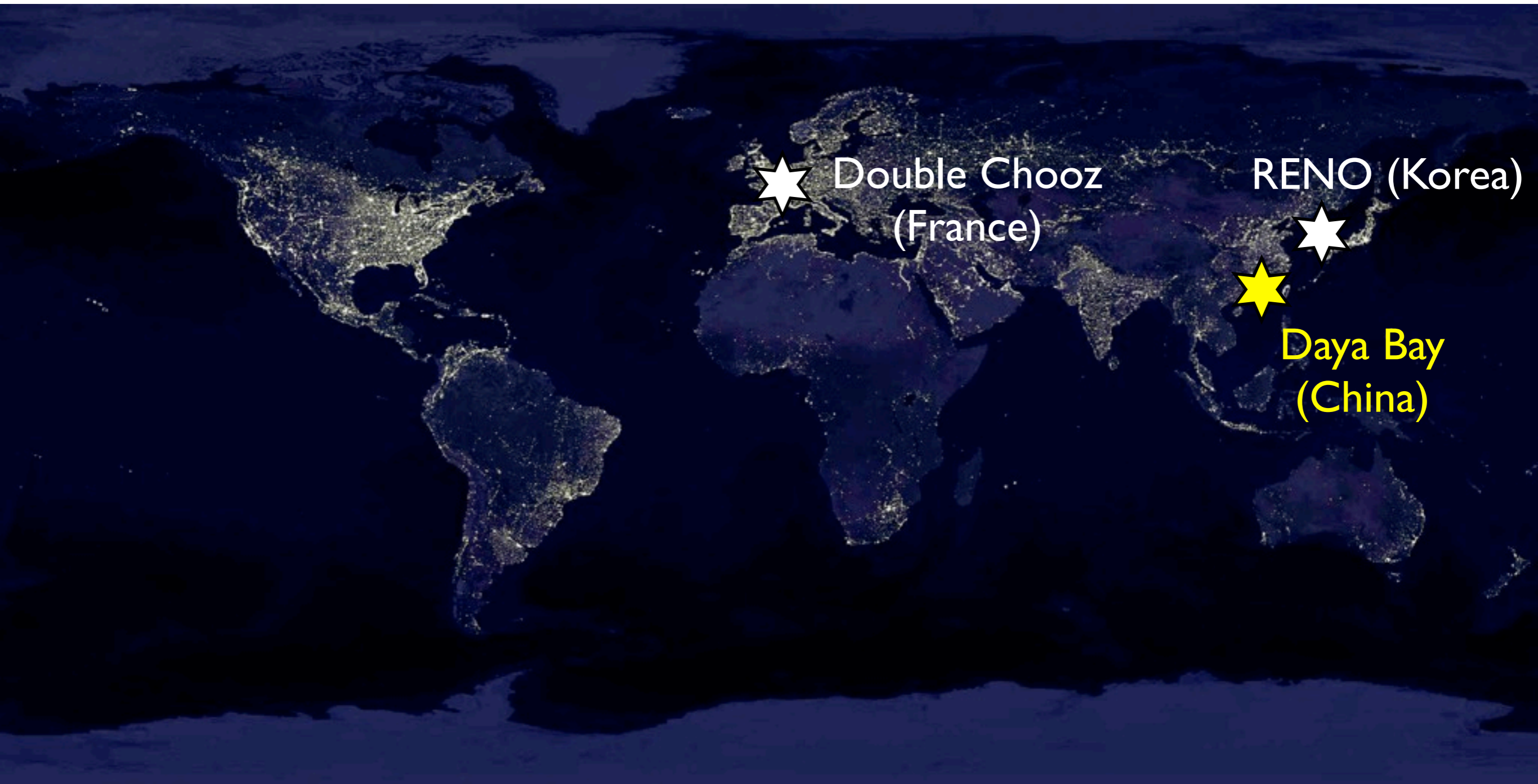

The Innovation: A “Near” Detector to Monitor the Flux



Hall 3:
860 mwe

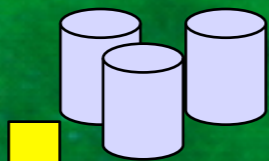

Mountains rising with distance from the bay.

Hall 2:
265 mwe



Water System

Liquid scintillator

Assembly

“Ling Ao”
2×2.9 GW

Hall 1:
250 mwe

“Daya Bay”
2×2.9 GW

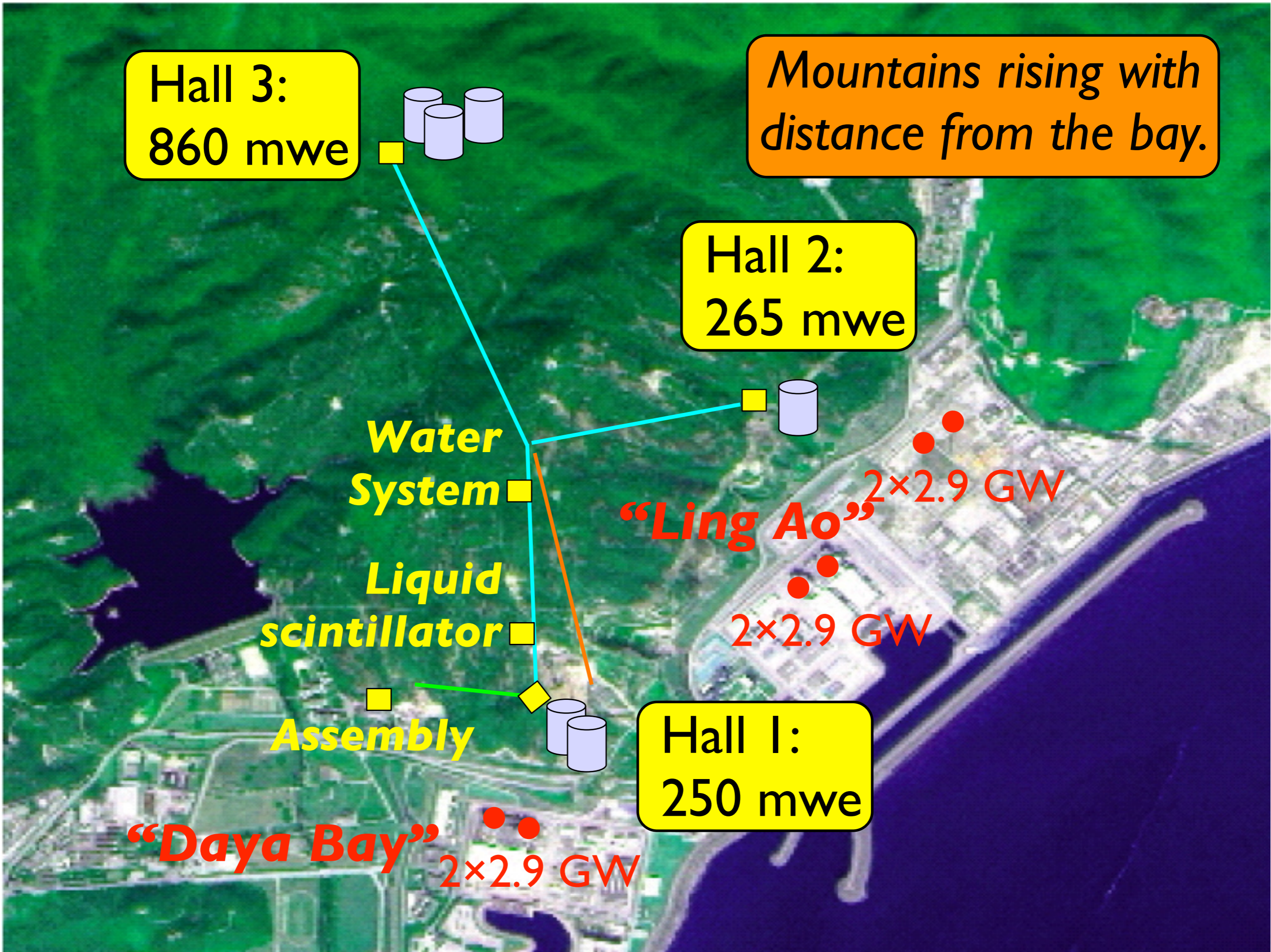

Hall 3:
860 mwe

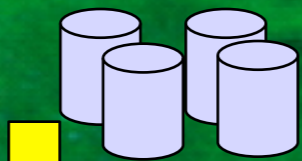

Mountains rising with distance from the bay.

Hall 2:
265 mwe



Water System

Liquid scintillator

Assembly

“Ling Ao”
2×2.9 GW

2×2.9 GW

Hall 1:
250 mwe



“Daya Bay”
2×2.9 GW

*Next phase
(Summer 2012)*

Detecting Reactor Antineutrinos

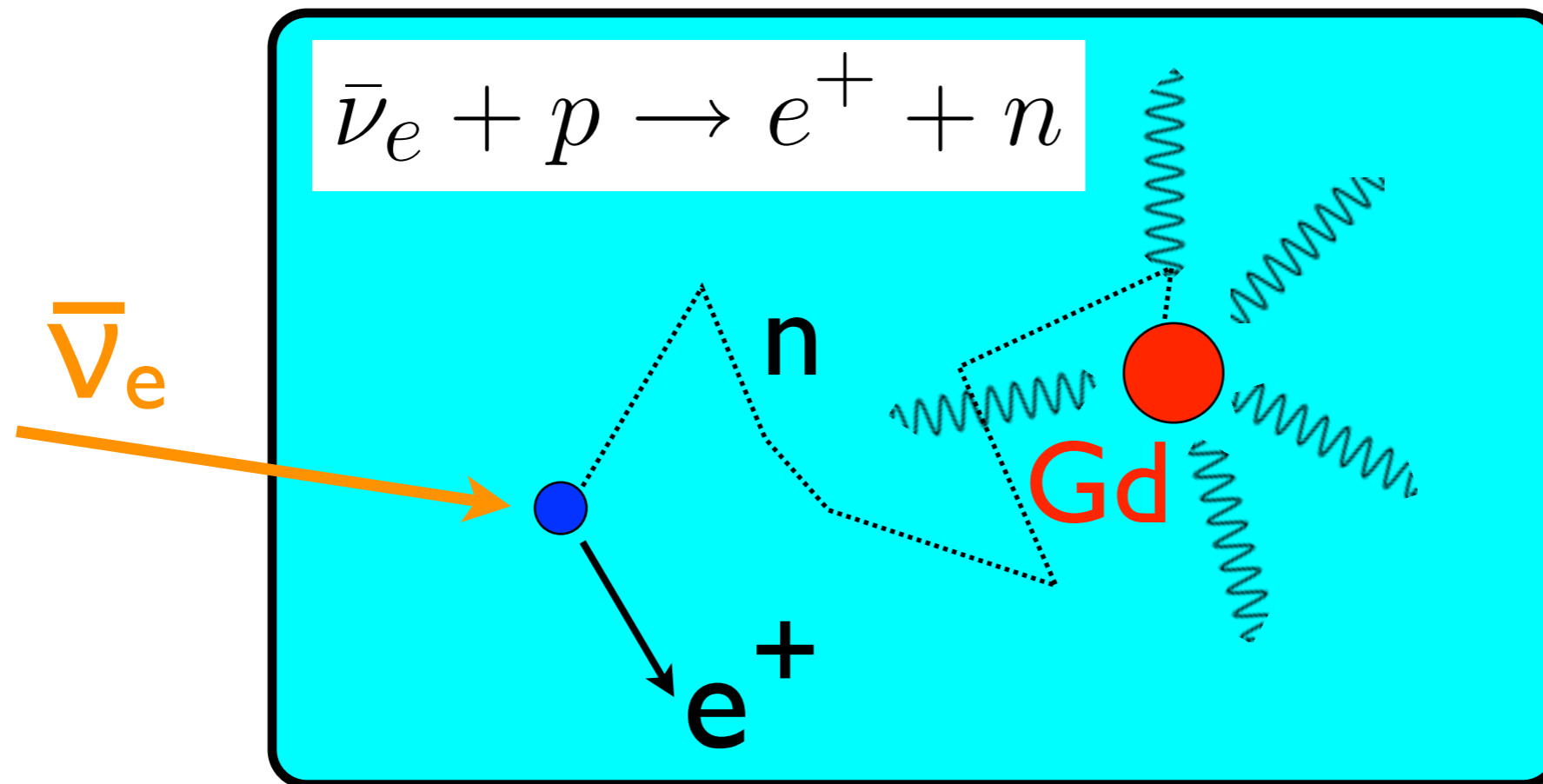

$$P_{ee} \approx 1 - \sin^2 2\theta_{13} \sin^2 \left(\frac{\Delta m_{31}^2 L}{4E_\nu} \right) - \cos^4 \theta_{13} \sin^2 2\theta_{12} \sin^2 \left(\frac{\Delta m_{21}^2 L}{4E_\nu} \right)$$

- Optimize baseline L using $\Delta m_{13}^2 = \Delta m_{23}^2$
- Monitor reactor flux with “near” detectors

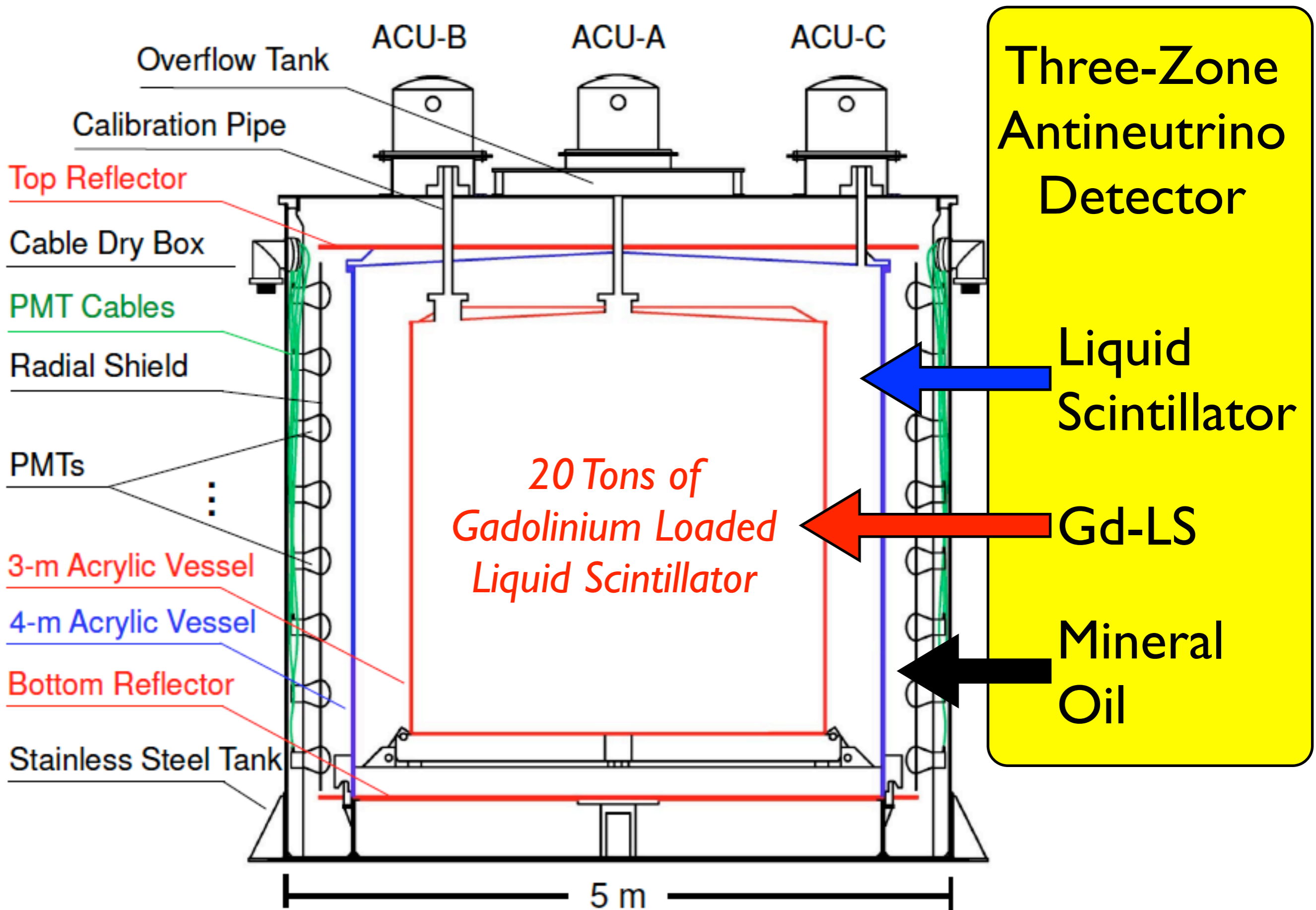

Antineutrino Detector Assembly

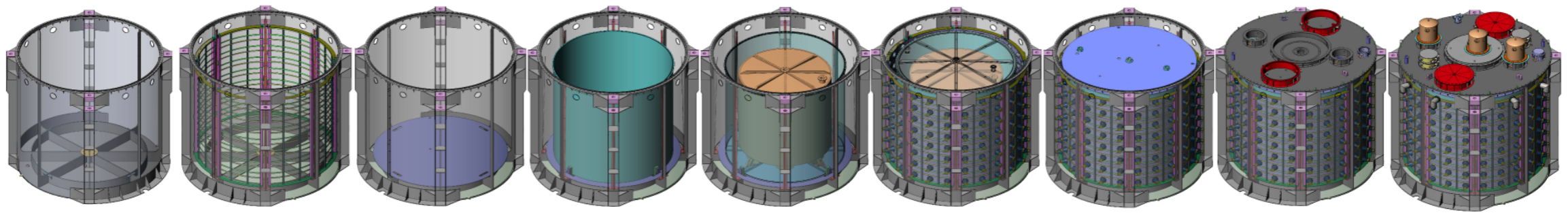

Antineutrino Detector Assembly

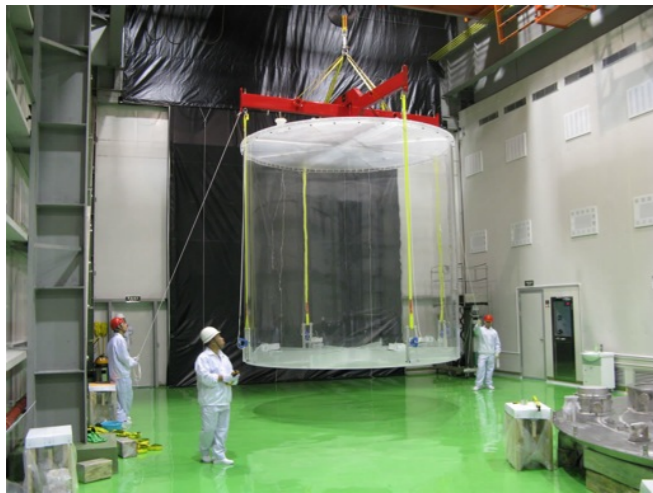
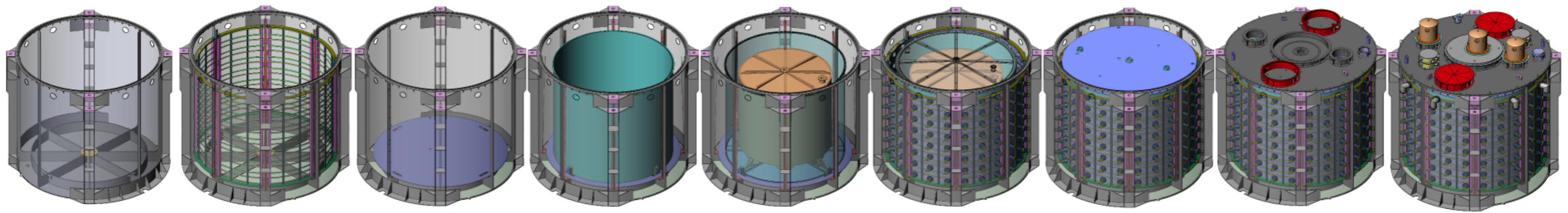

Antineutrino Detector Assembly

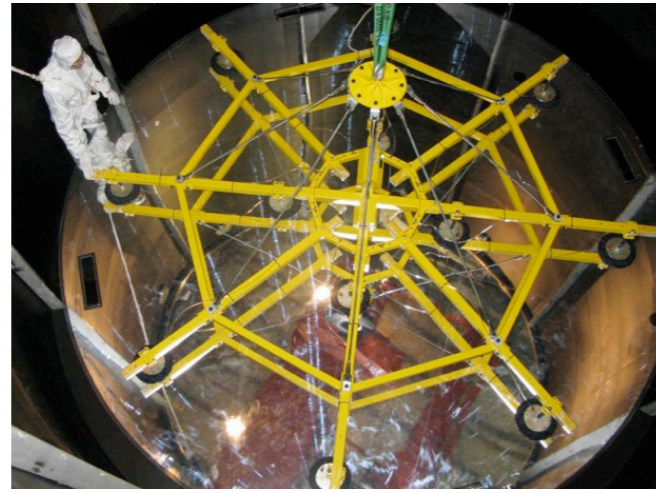
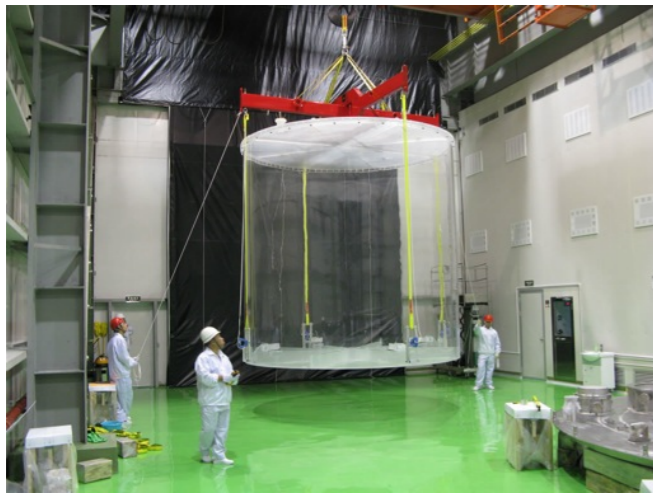
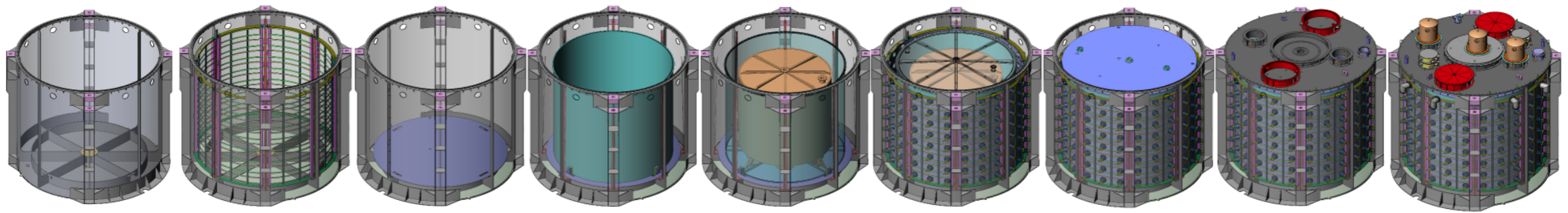

Antineutrino Detector Assembly

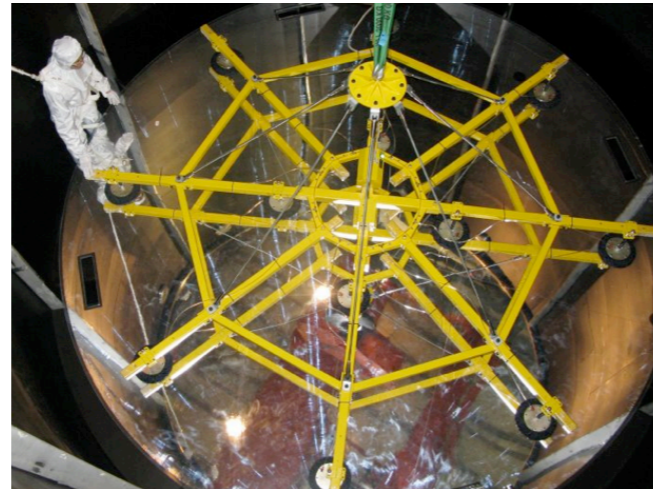
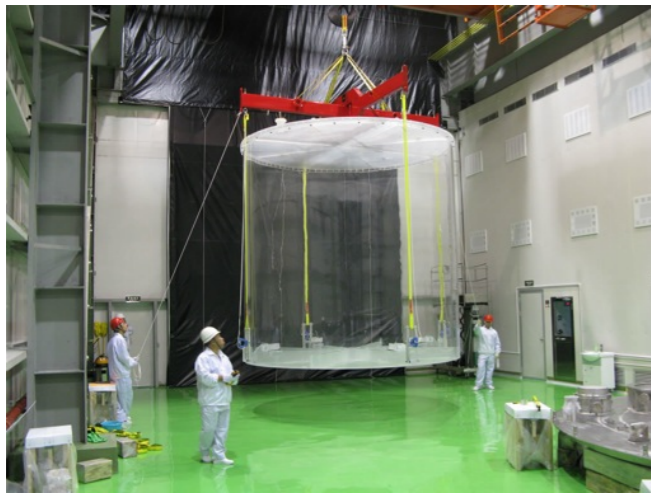
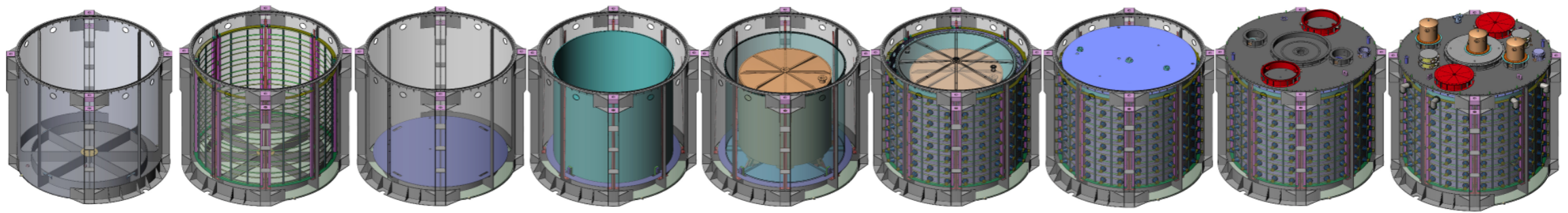

Antineutrino Detector Assembly

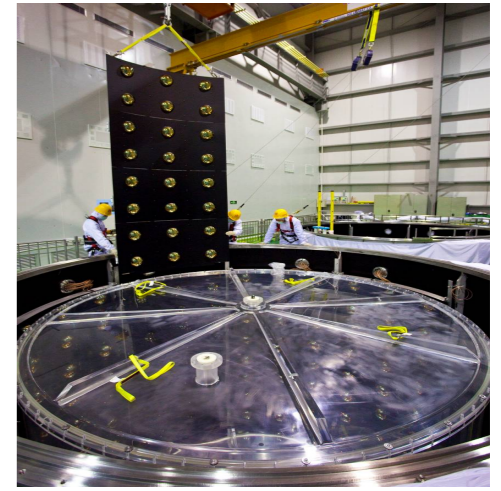
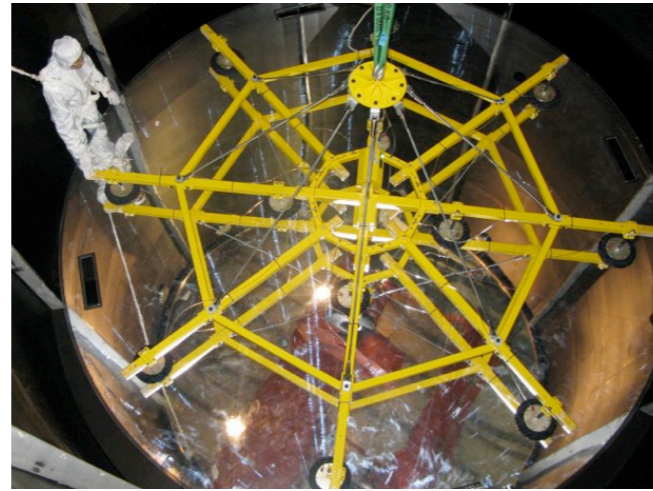
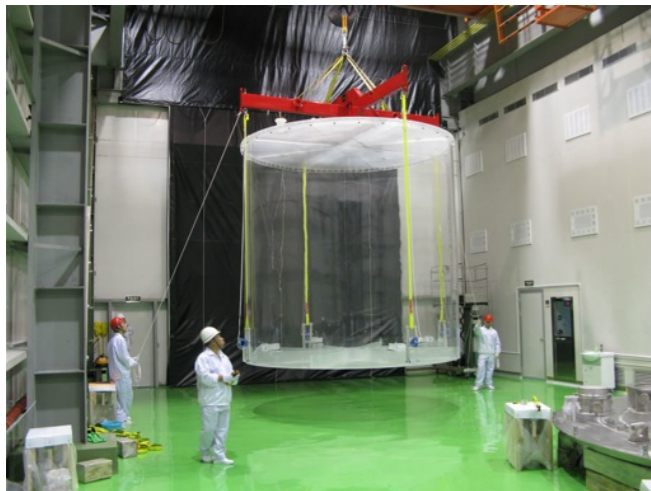
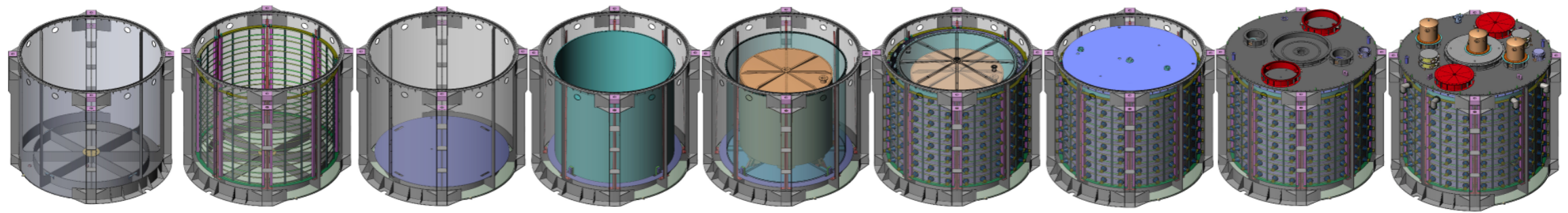

Antineutrino Detector Assembly

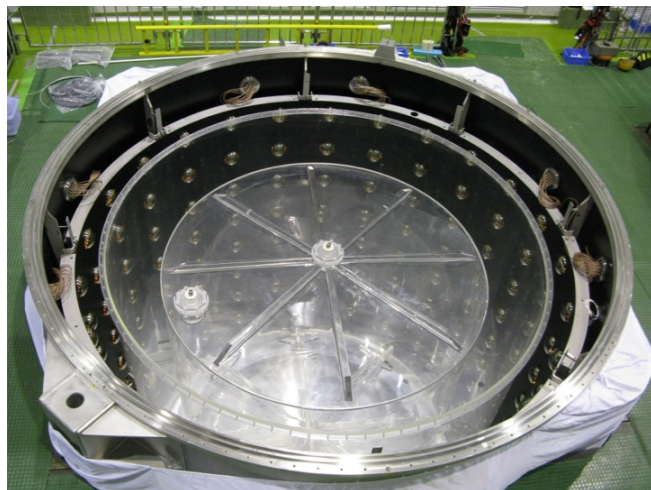
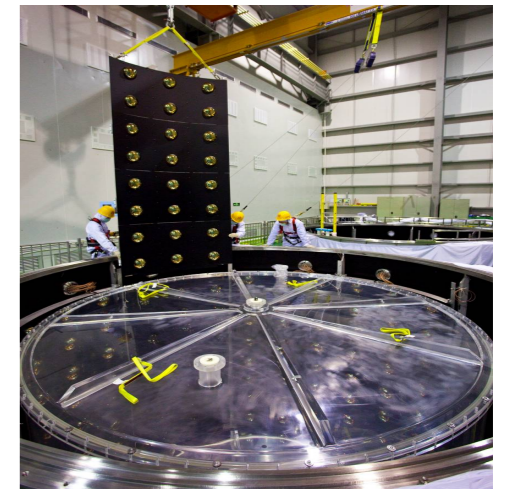
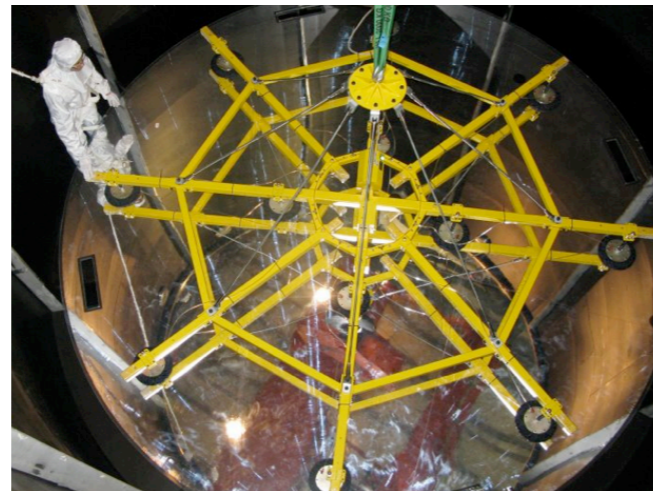
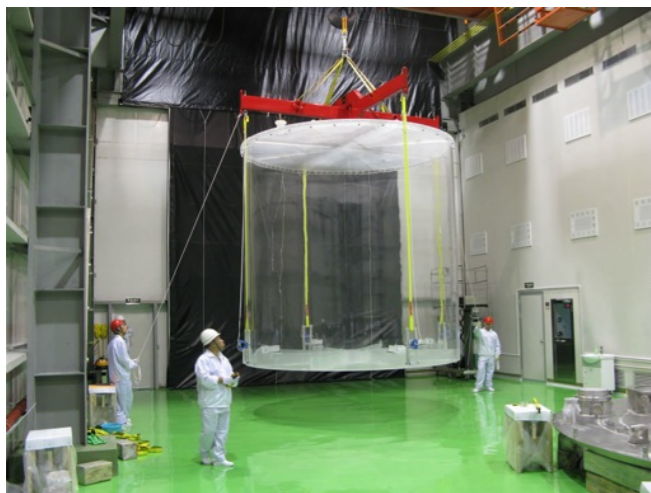
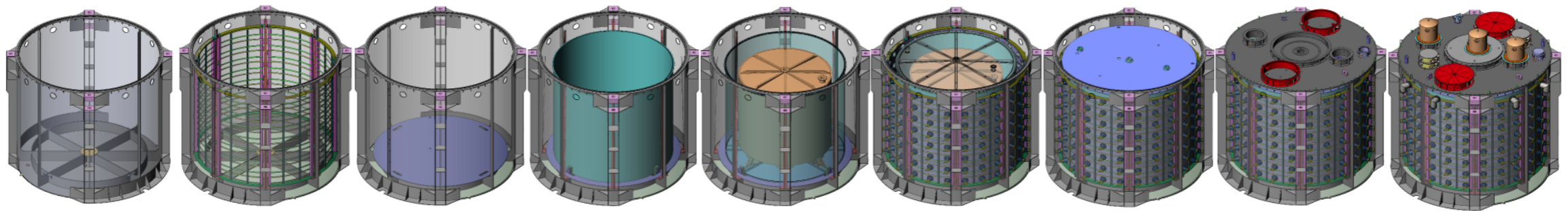

Antineutrino Detector Assembly

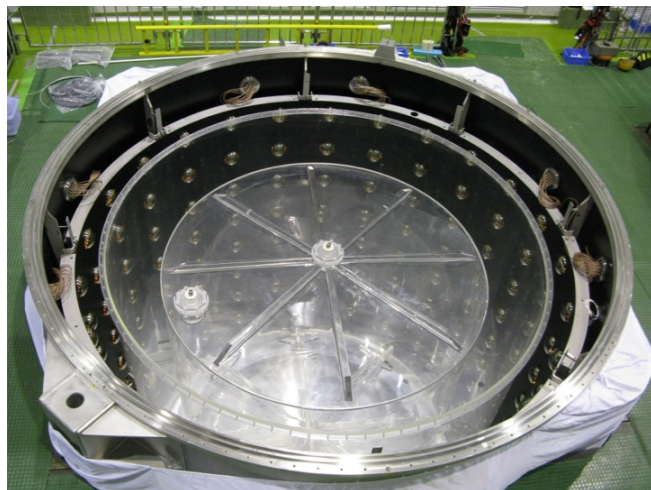
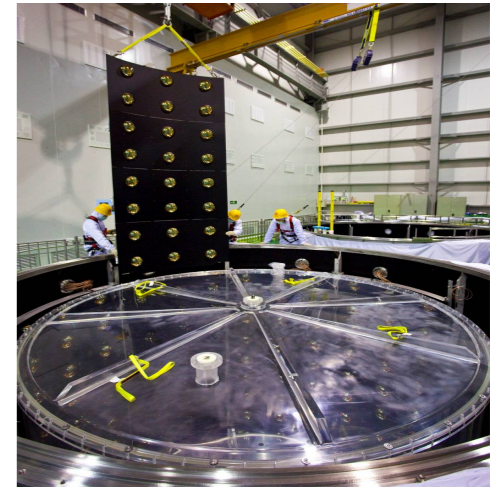
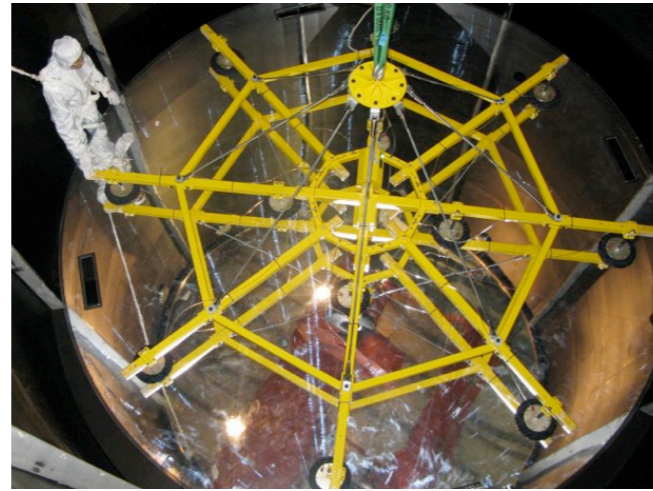
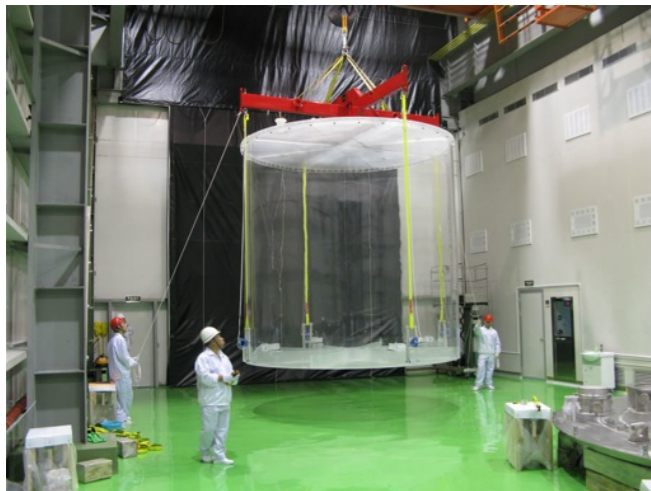
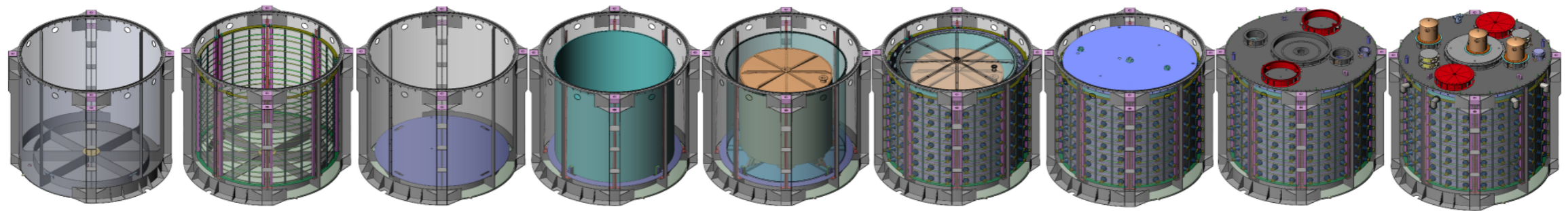

Antineutrino Detector Assembly

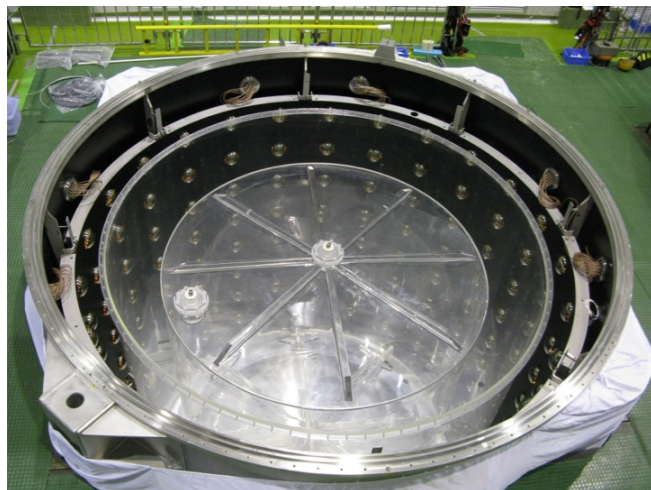
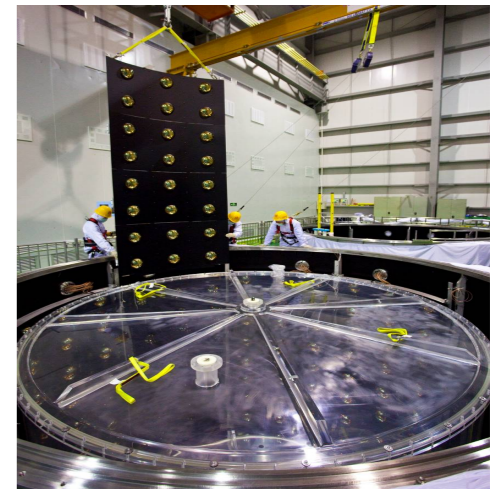
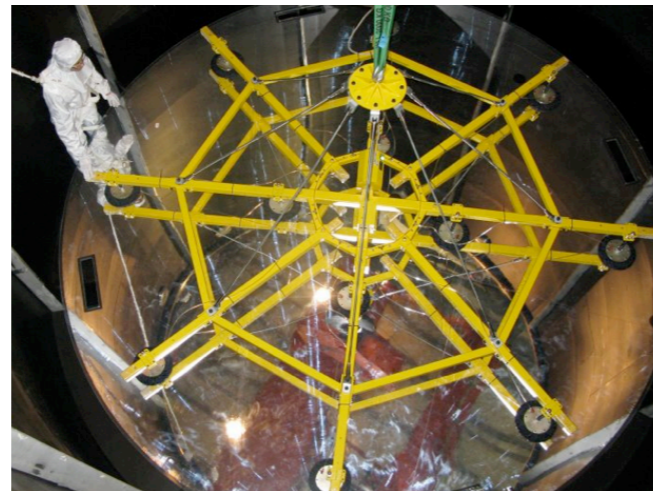
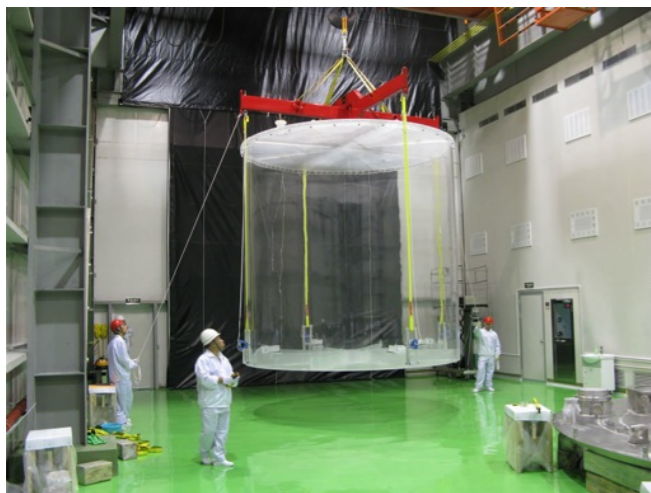
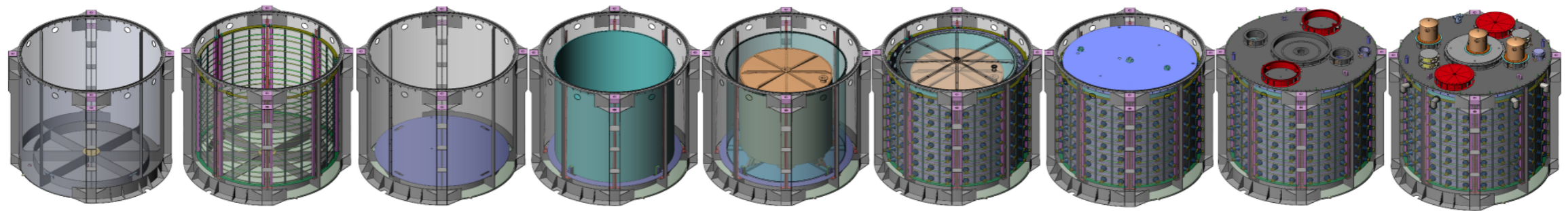

and off to get filled ...

Liquid Scintillator

Linear Alkyl Benzene (LAB) w/Gd (0.1%)+PPO (3g/L)+bis-MSB (15mg/L)

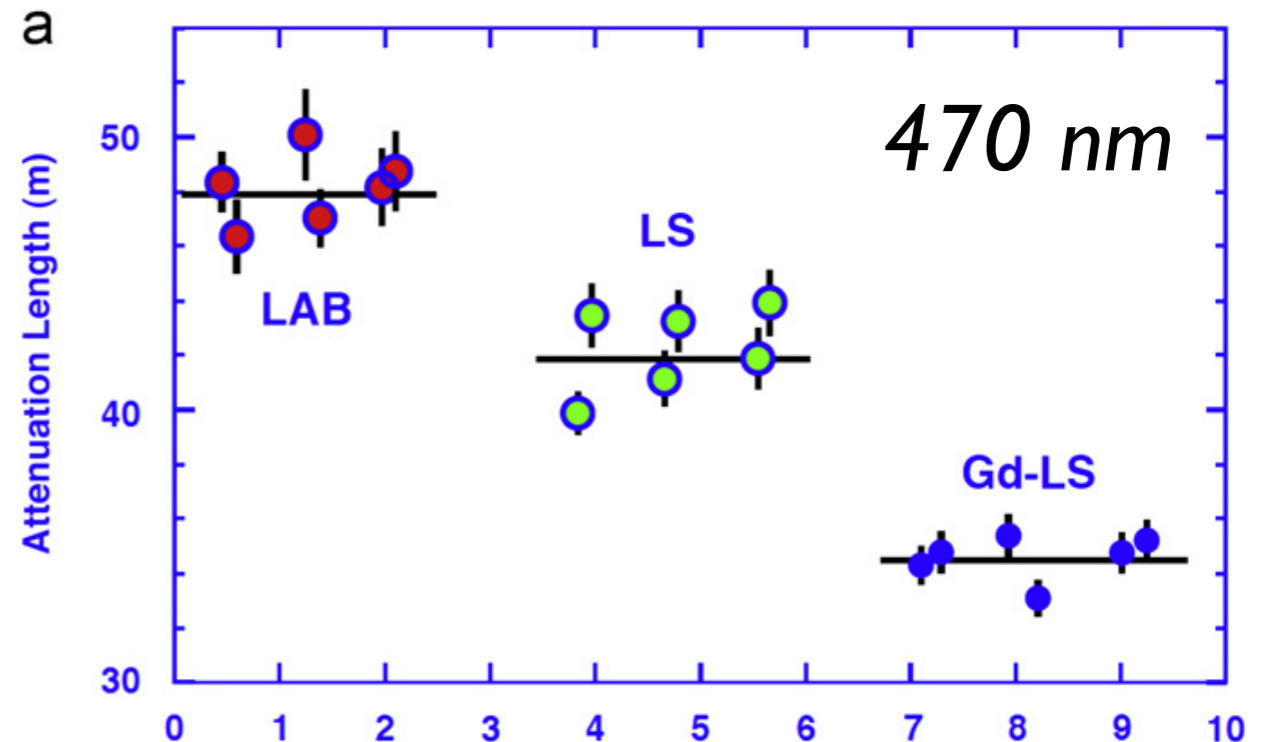
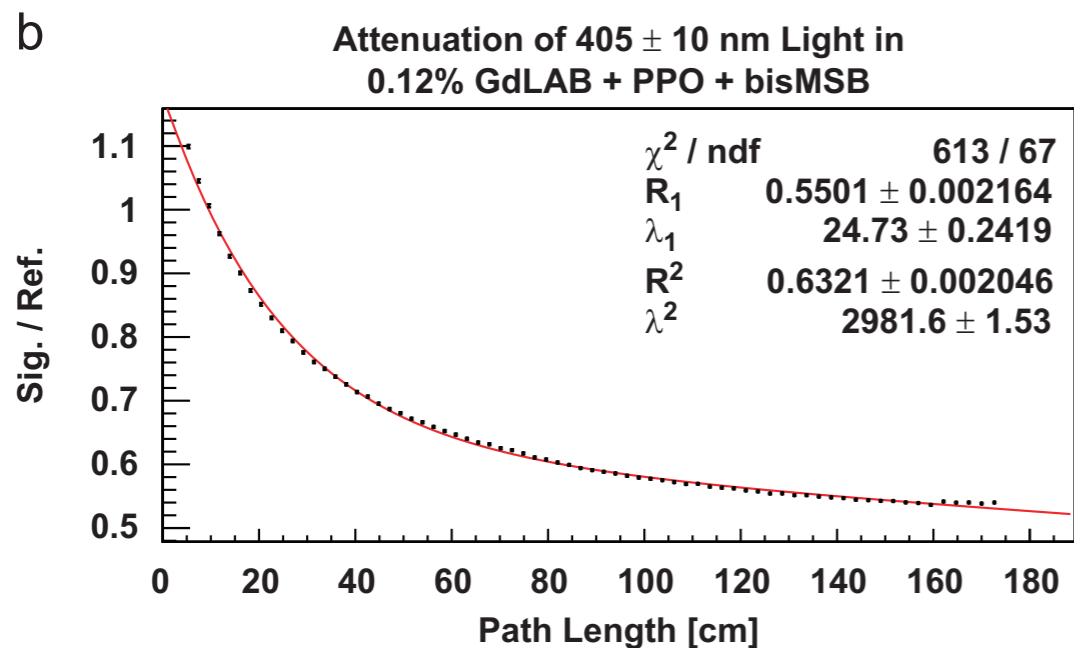
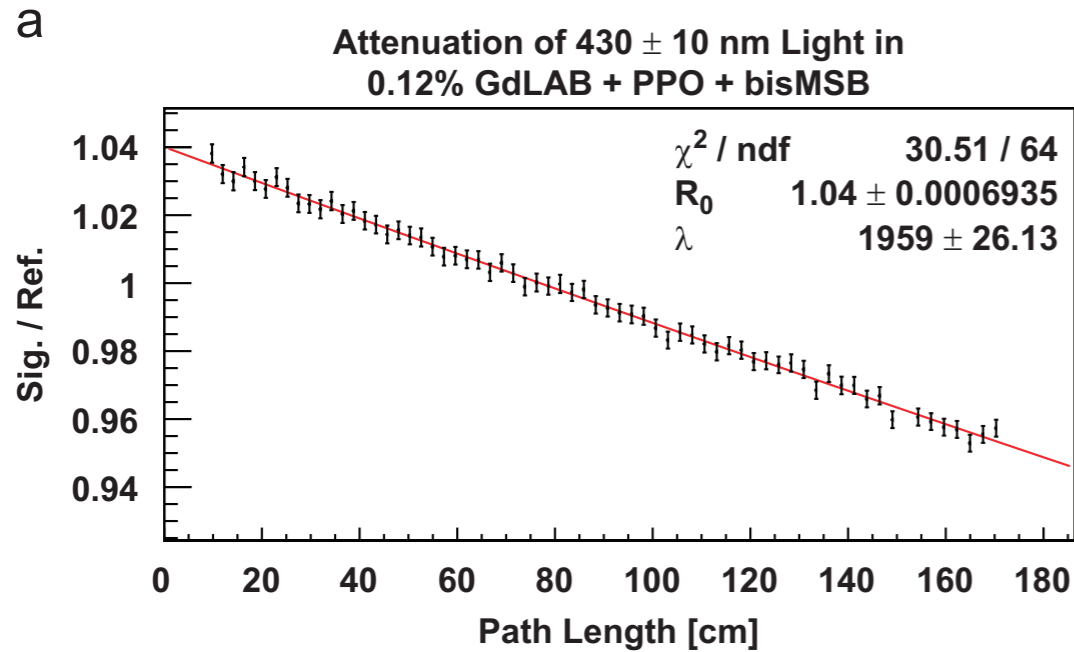

NIM A 637 (2011) 47

NIM A 584 (2008) 238

Underground scintillator facility

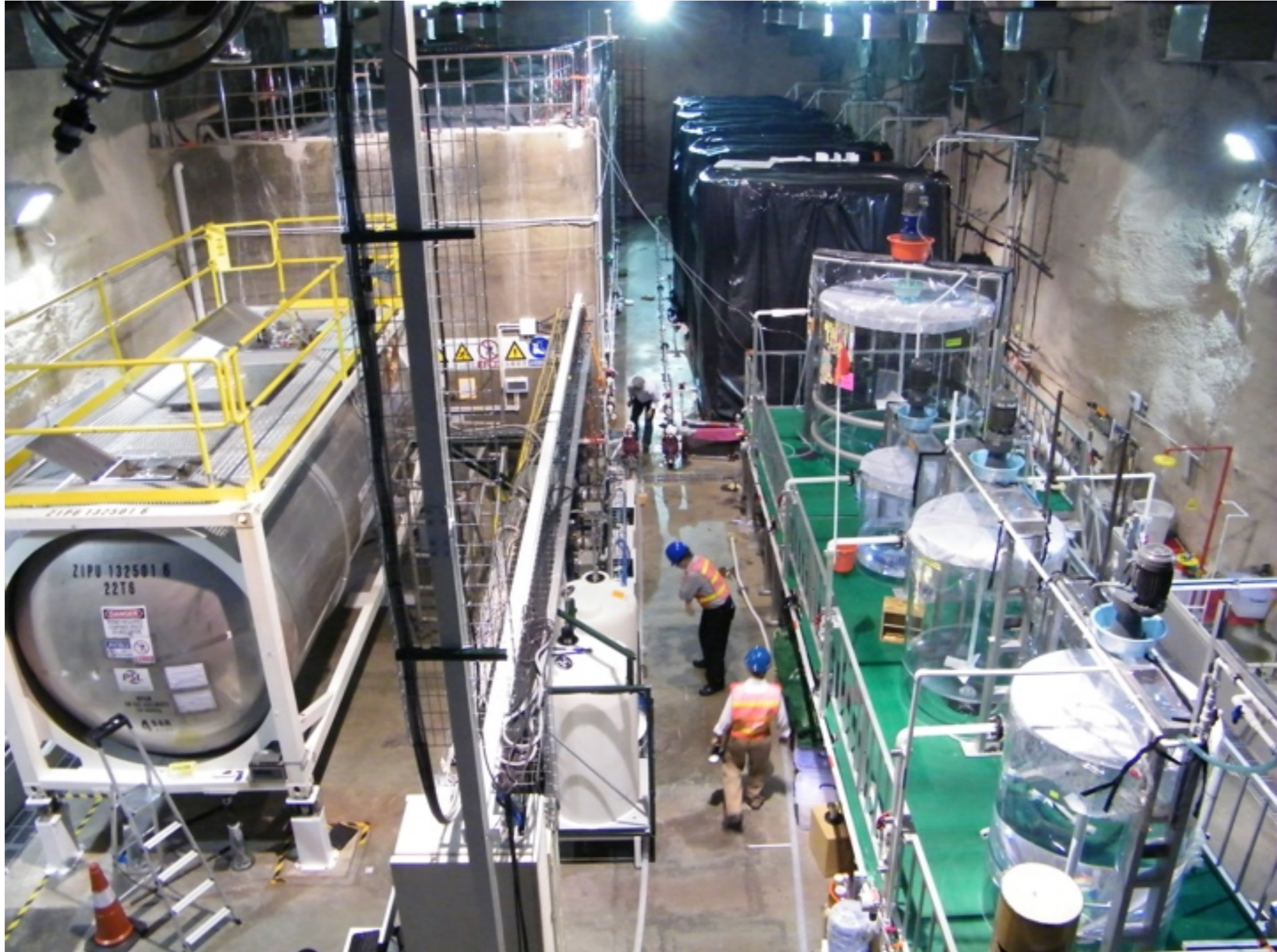

Detector Filling and Target Mass Measurement

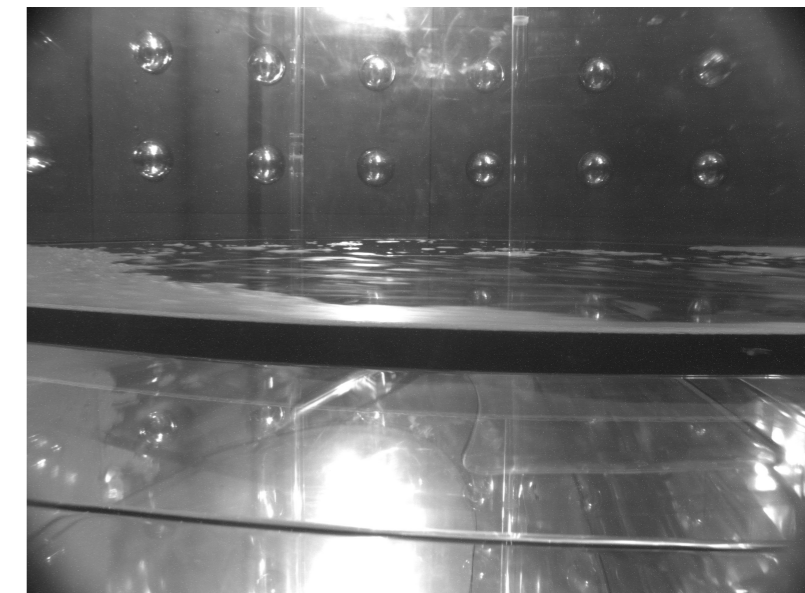
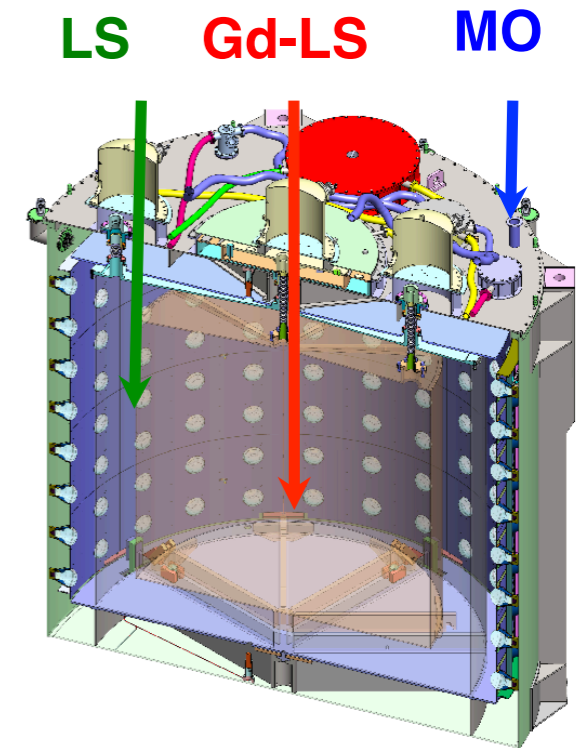
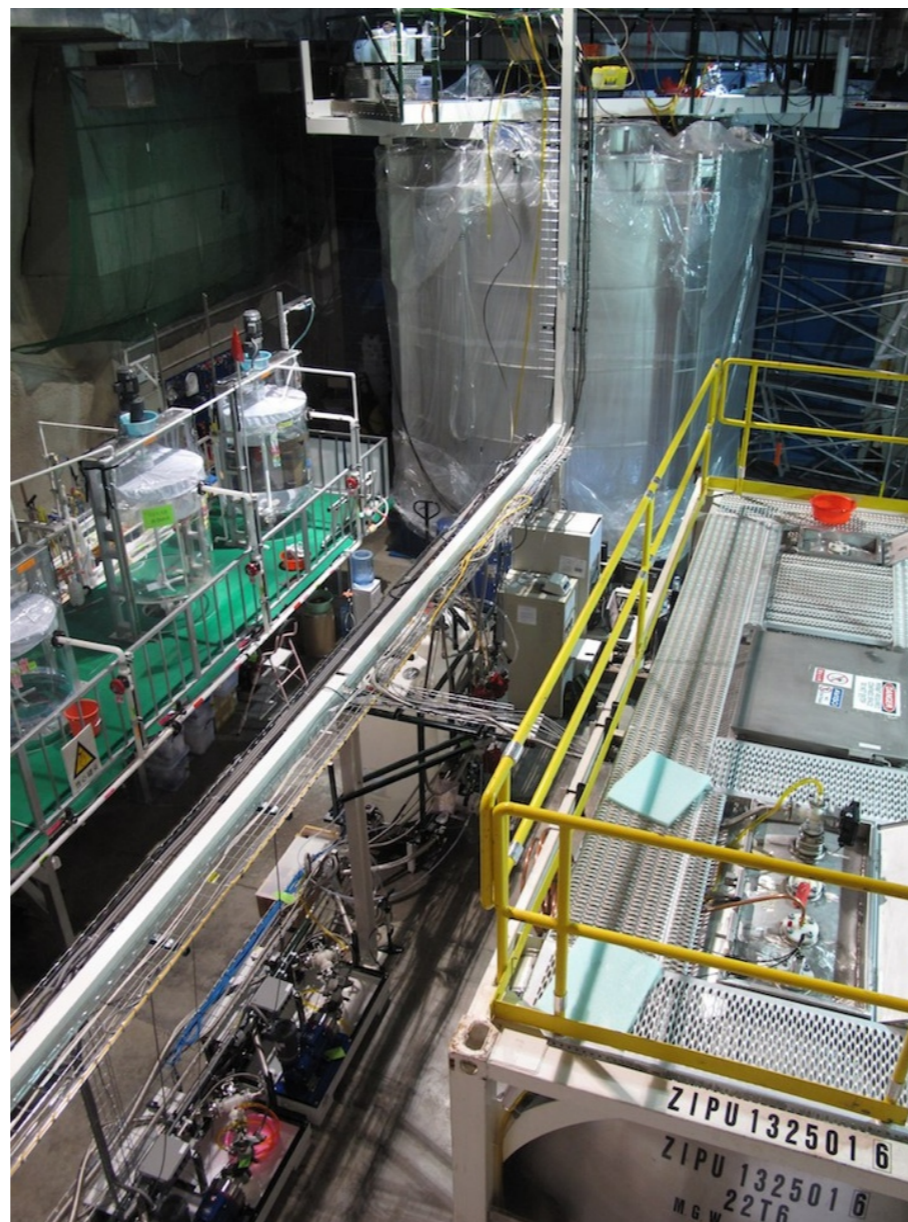

Quantity	Relative	Absolute
protons/kg	neg.	0.47%
Density (kg/L)	neg.	neg.
Total mass	0.015%	0.015%
Overflow tank geometry	0.0066%	0.0066%
Overflow sensor calibration	0.0043%	0.0043%
Bellows Capacity	0.0025%	0.0025%
Target mass	0.017%	0.017%
Target protons	0.017%	0.47%

Target mass determination error \pm 3kg out of 20,000

<0.03% during data taking period

Detectors are filled from same reservoirs “in-pairs” within < 2 weeks.

Scintillator stability is critical...

In the detectors:

In the production facility:

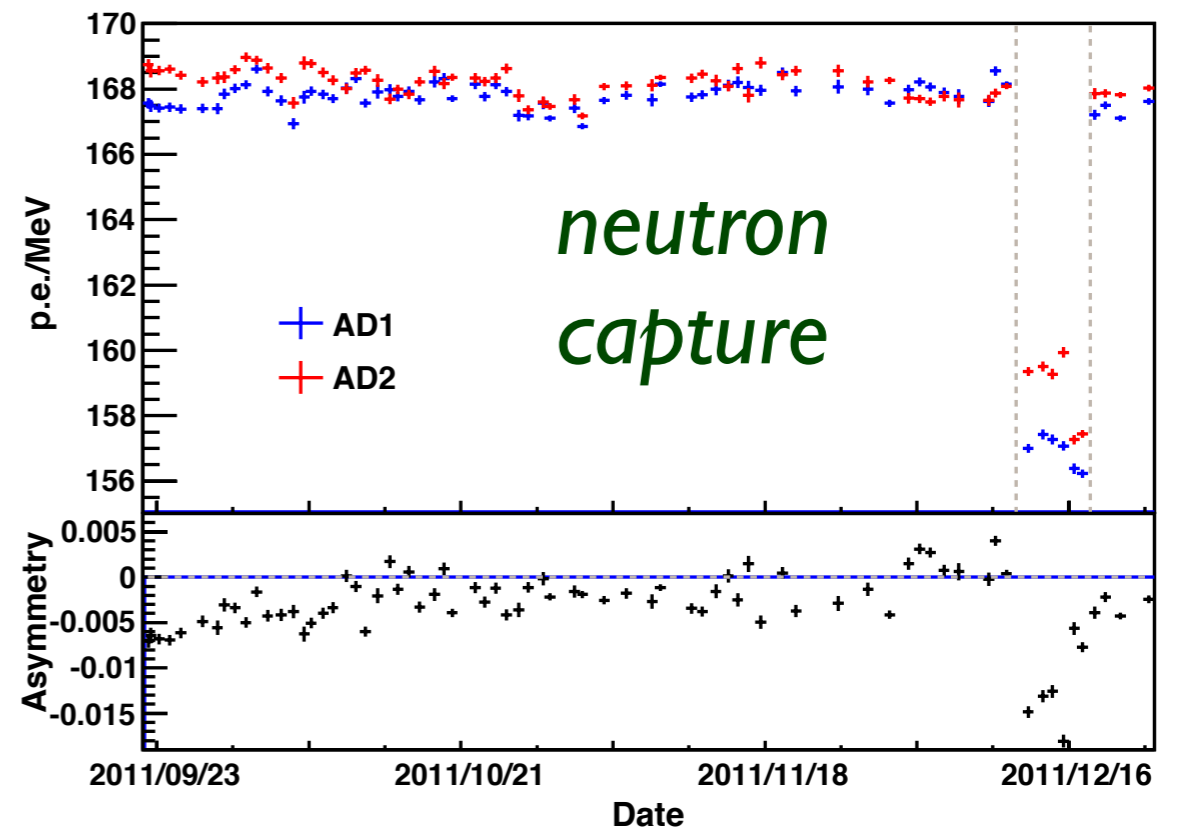
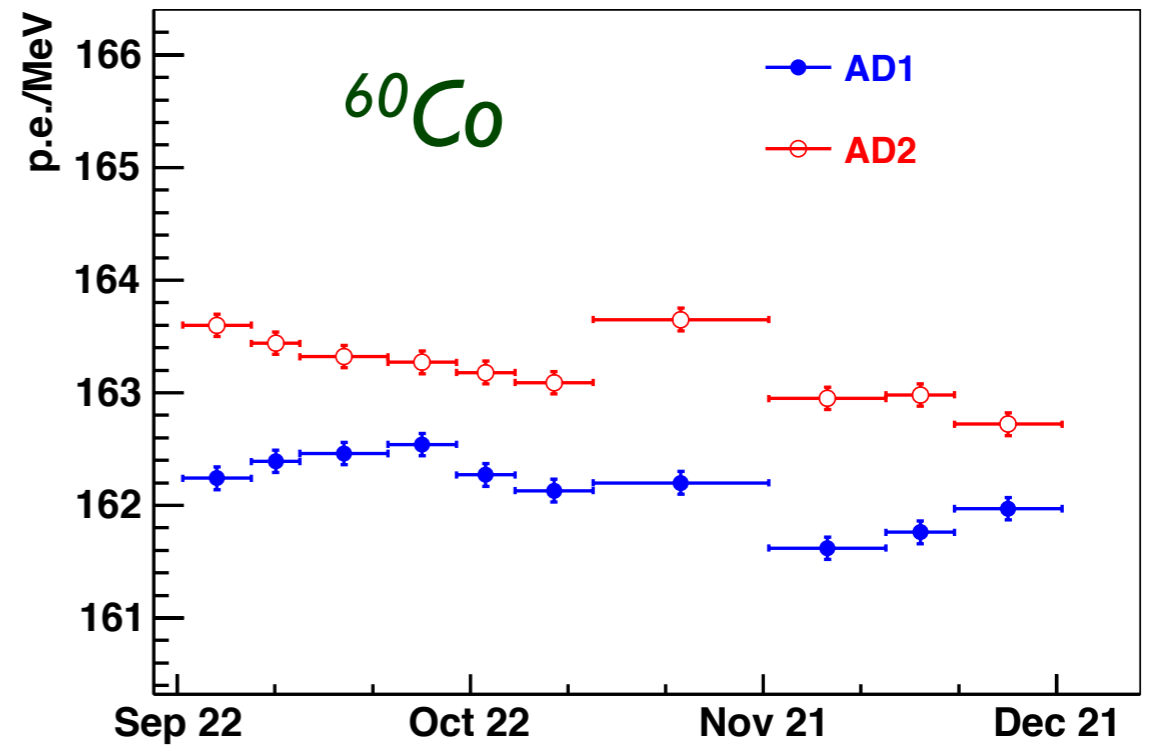
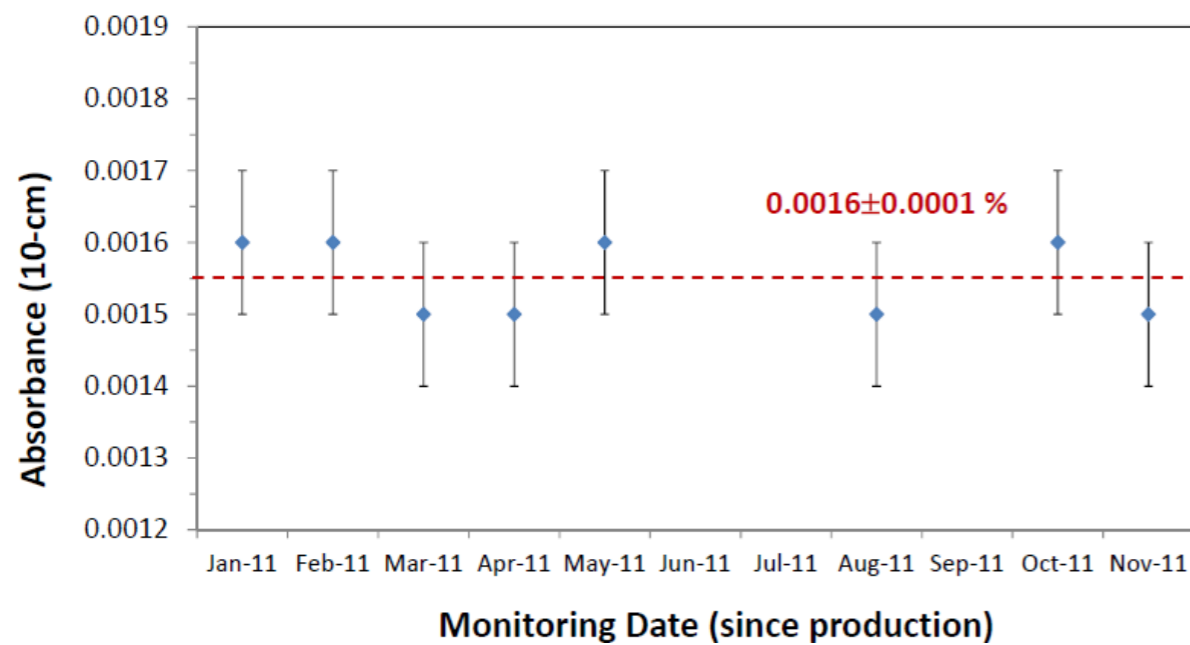

Water for Shielding and Muon Veto

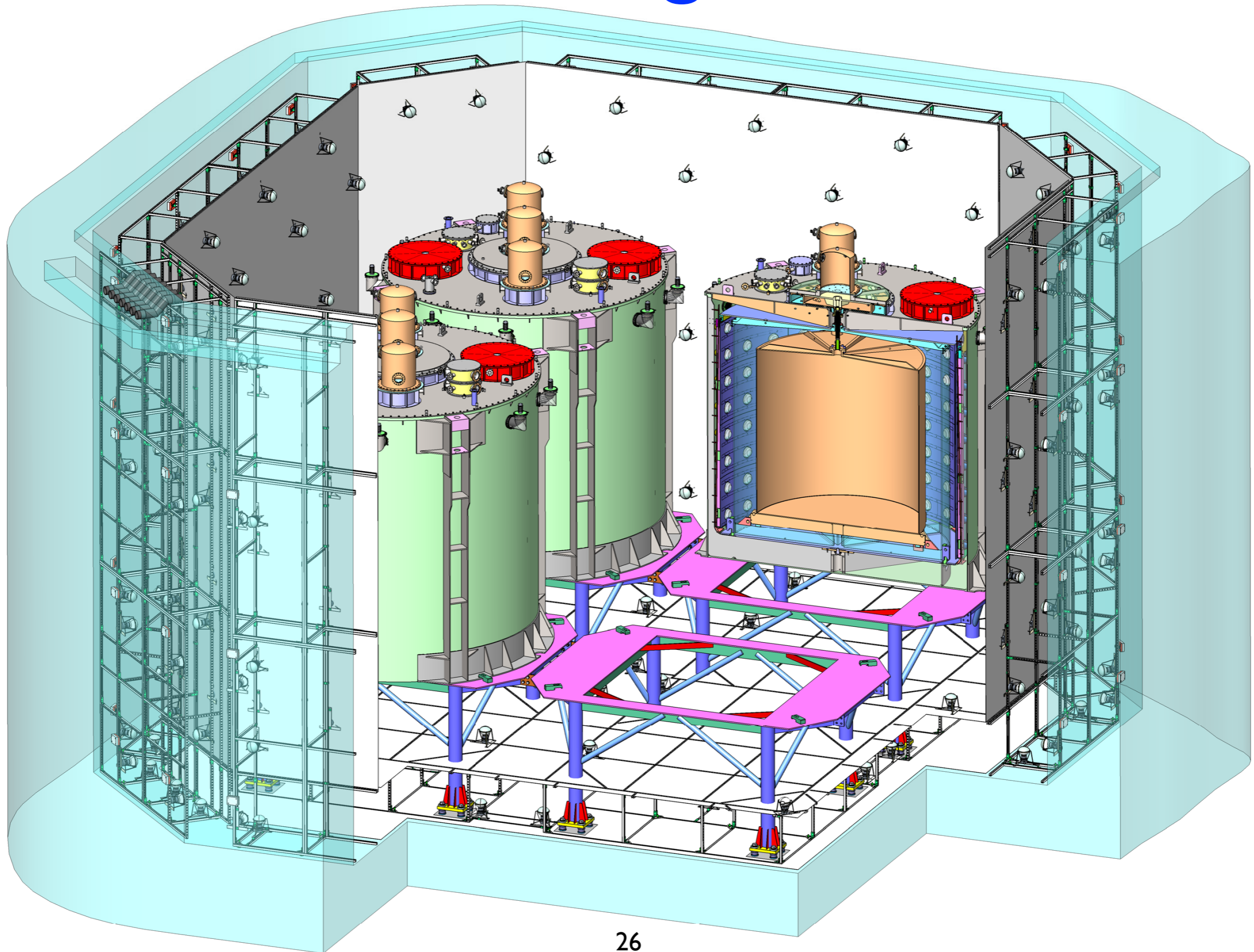

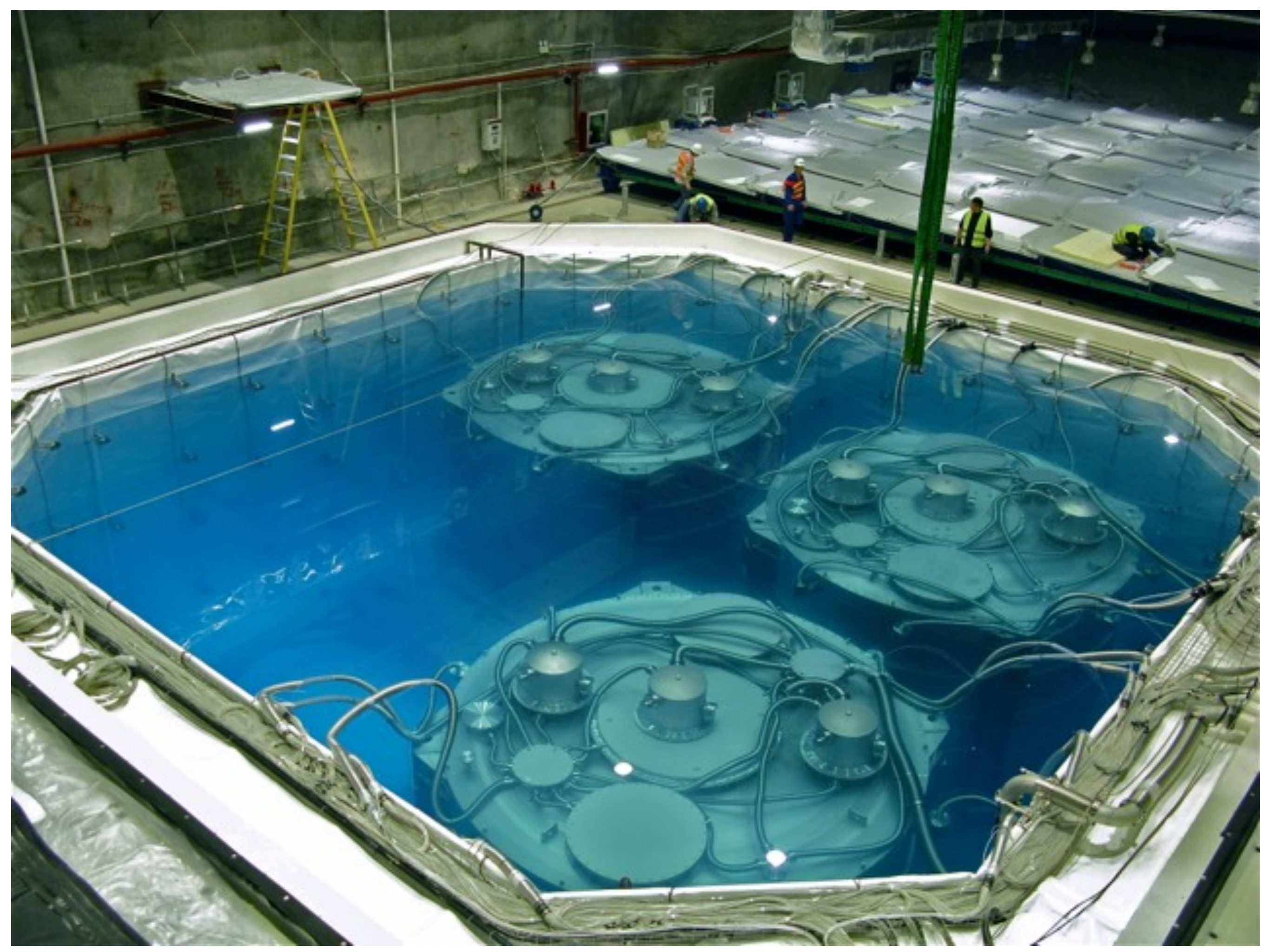

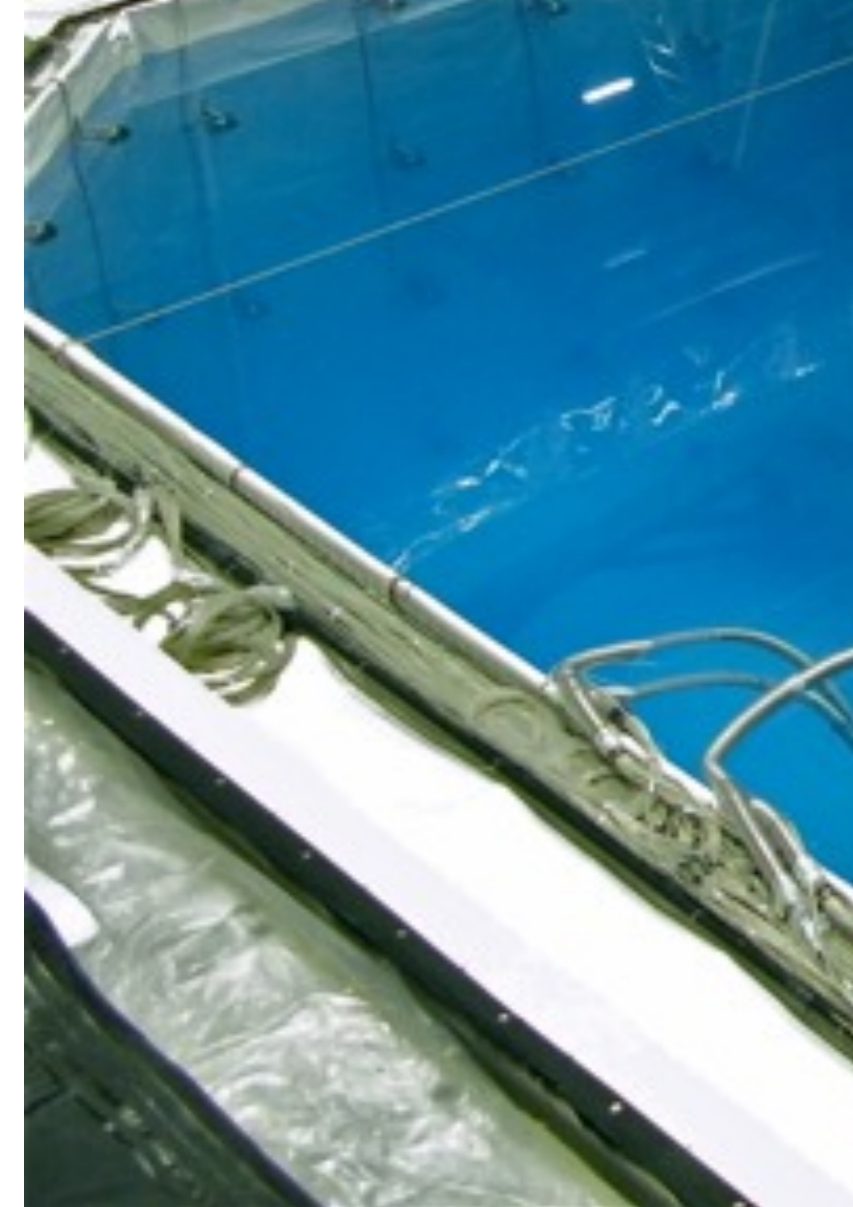
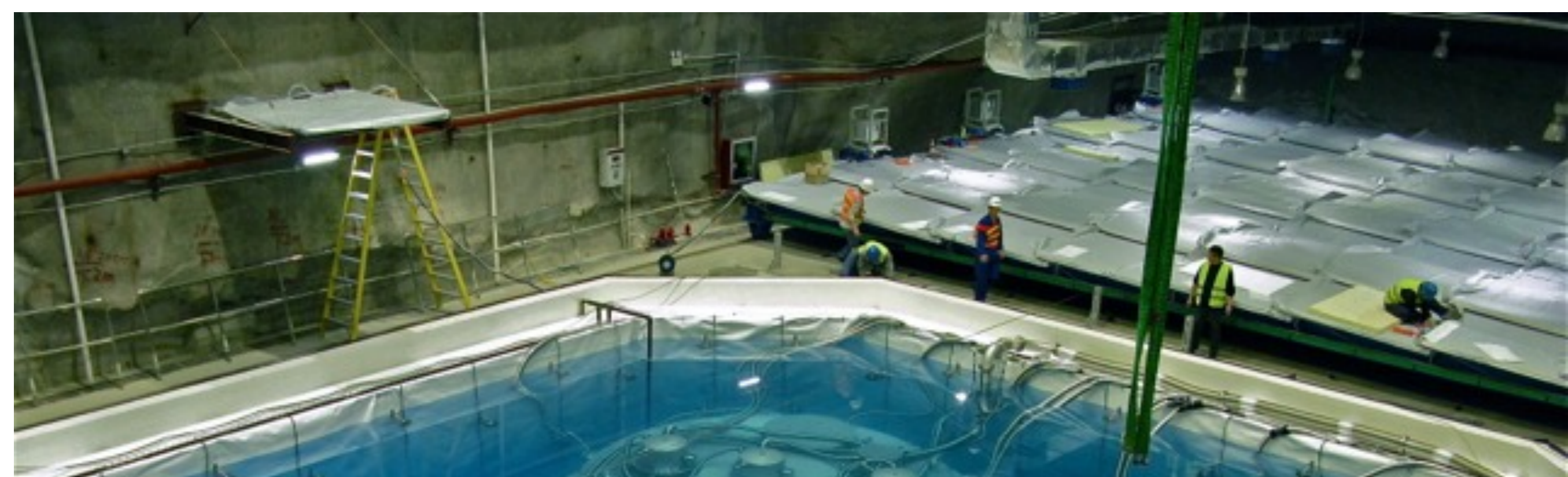

Passive Shield for Radioactivity

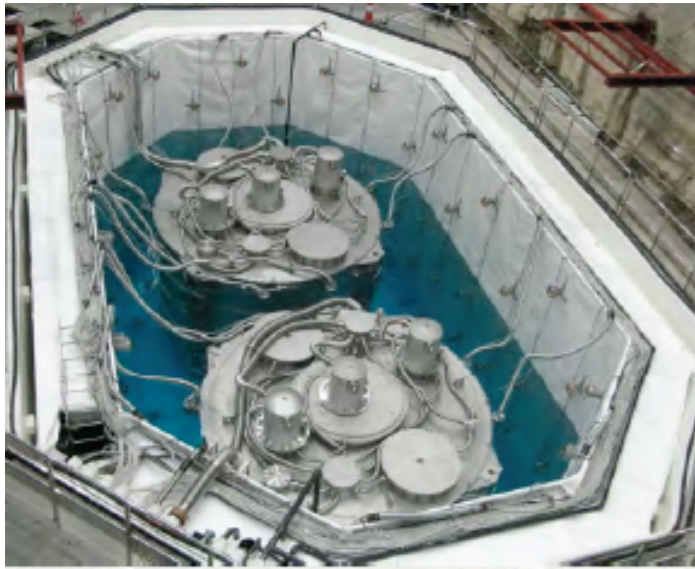

AD Reconstructed Position

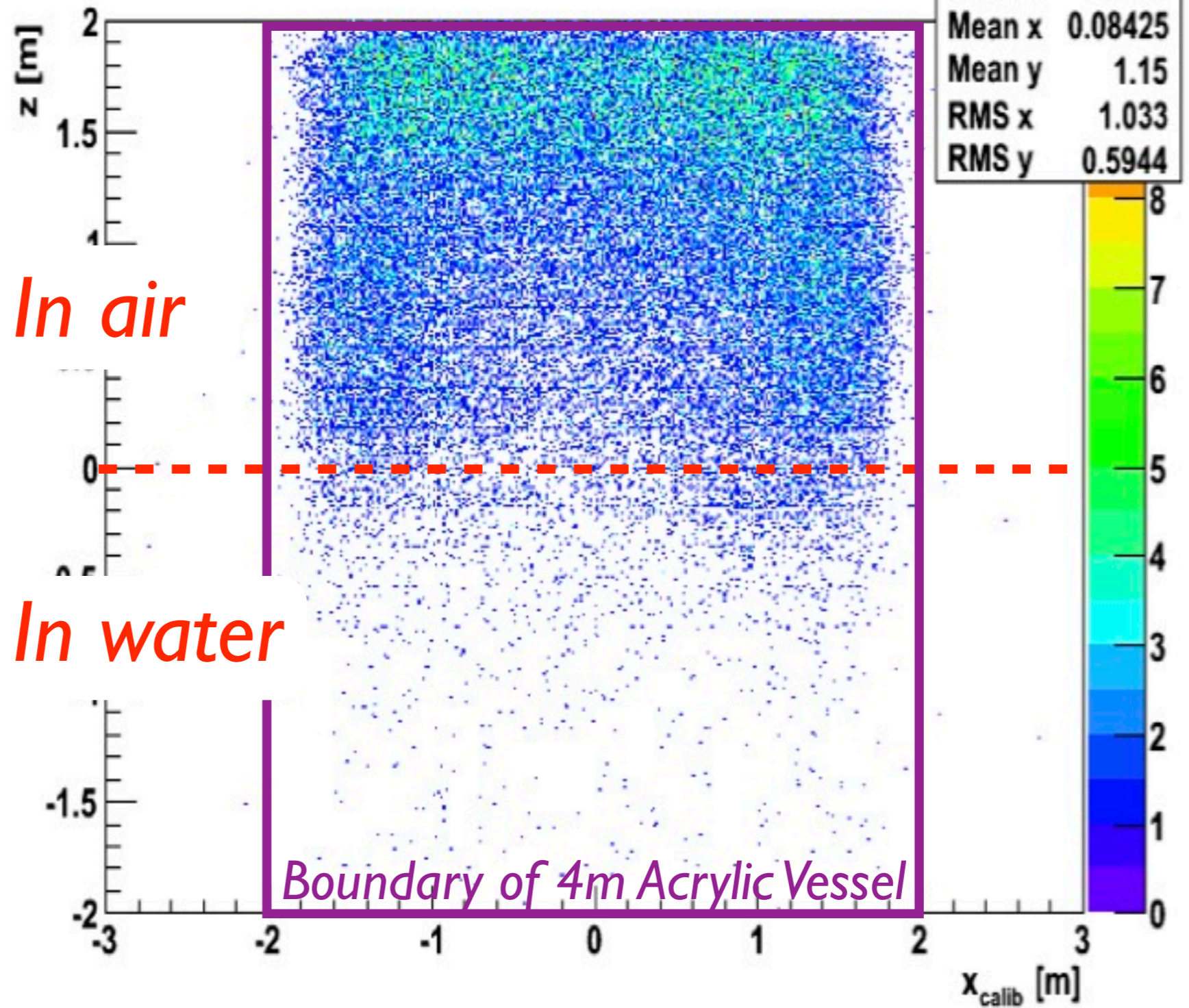

Instrumented Veto System

Install PMTs



Instrumented Veto System

Install PMTs



Tyvek covering

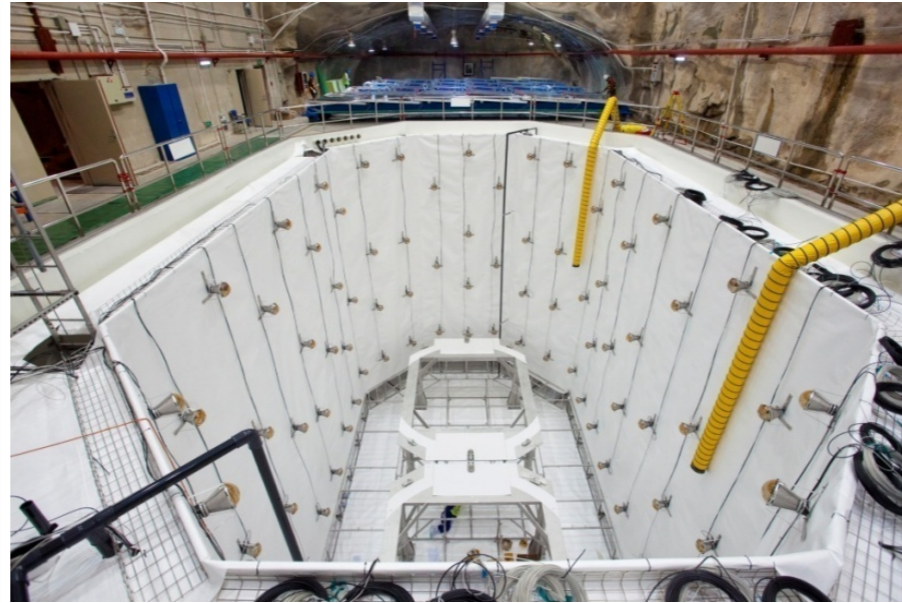

Instrumented Veto System

Install PMTs



Tyvek covering

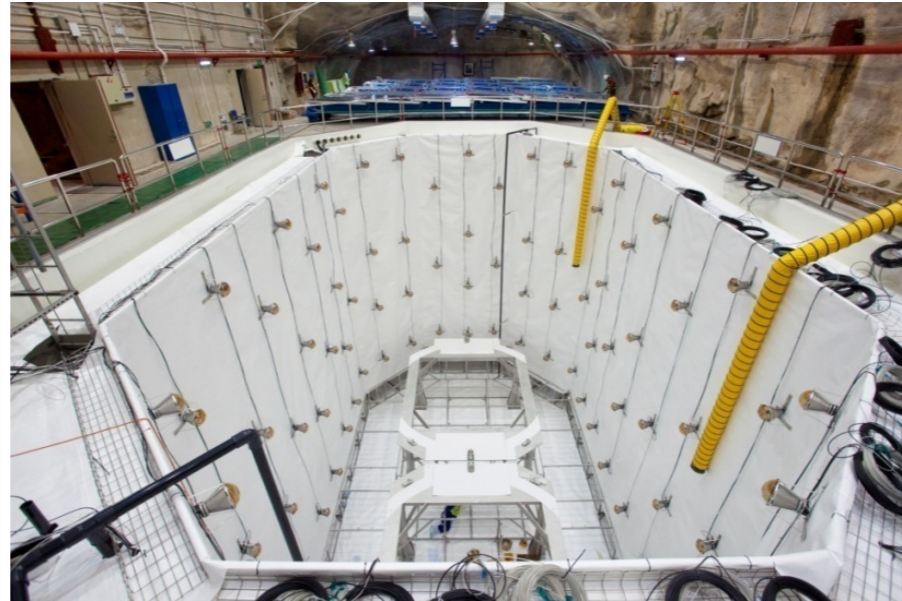

Install AD's

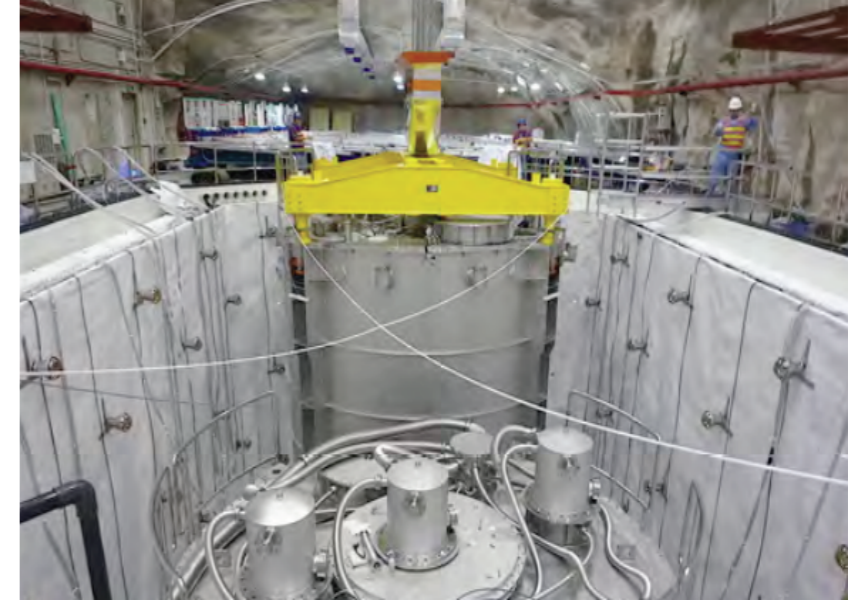

Instrumented Veto System

Install PMTs



Tyvek covering

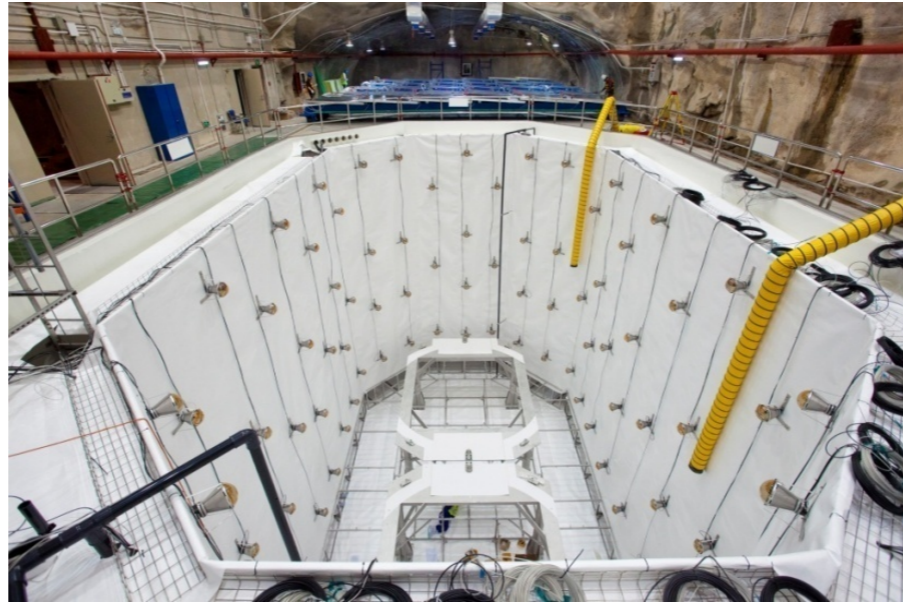

Install AD's

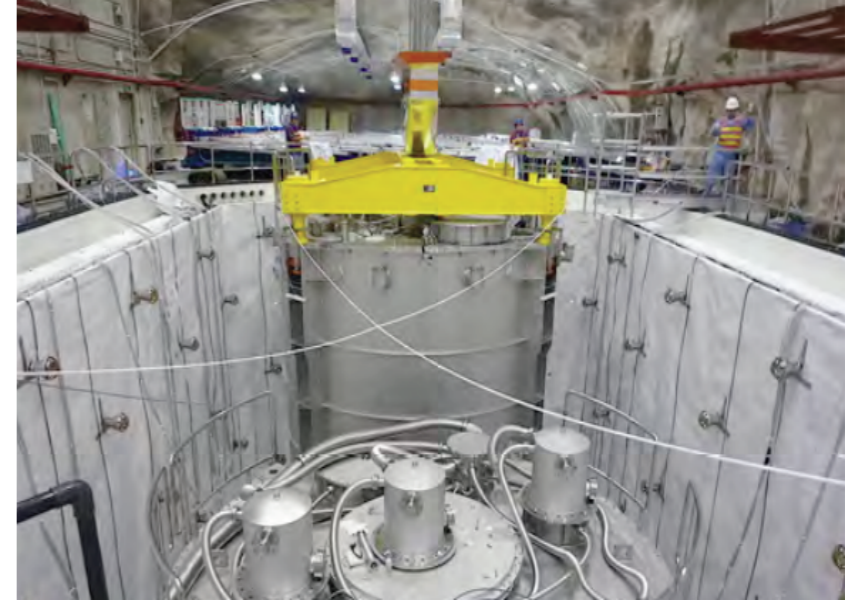

Fill the pool

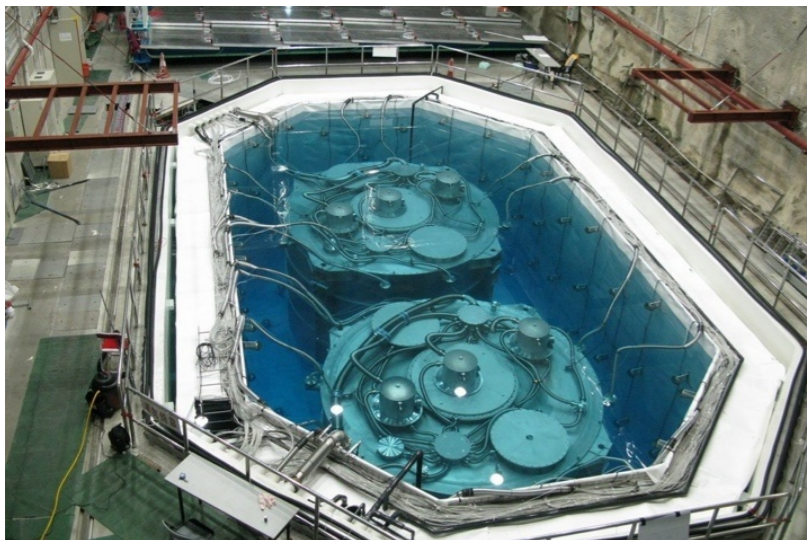

Instrumented Veto System

Install PMTs



Tyvek covering

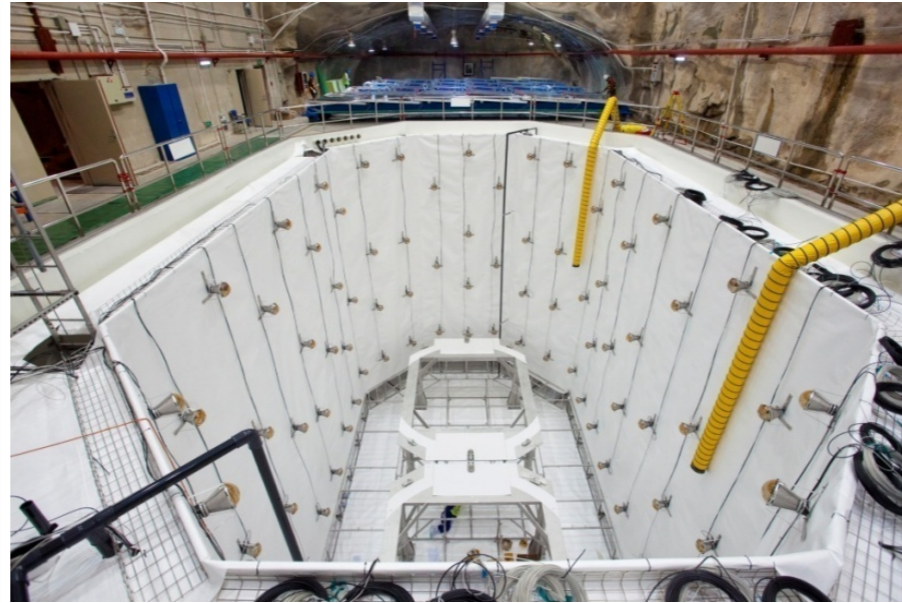

Install AD's

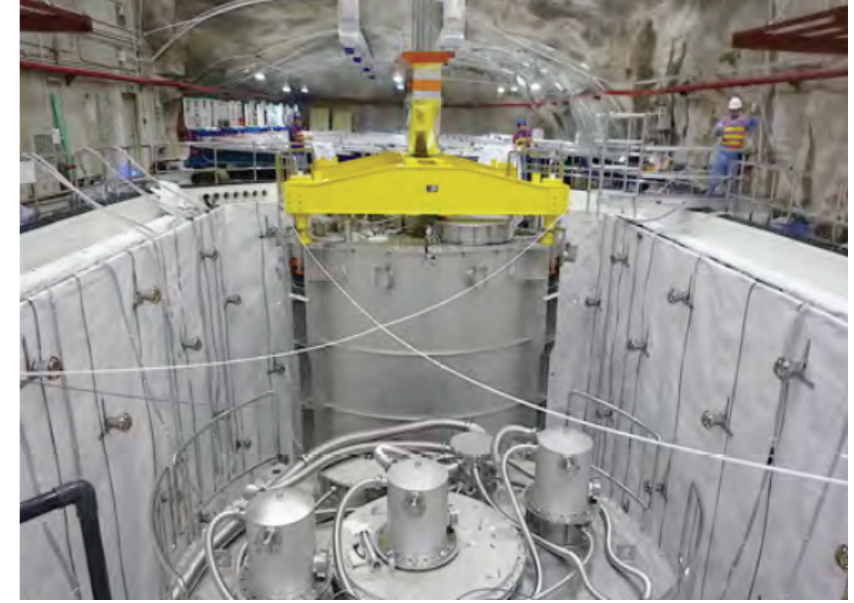

Fill the pool

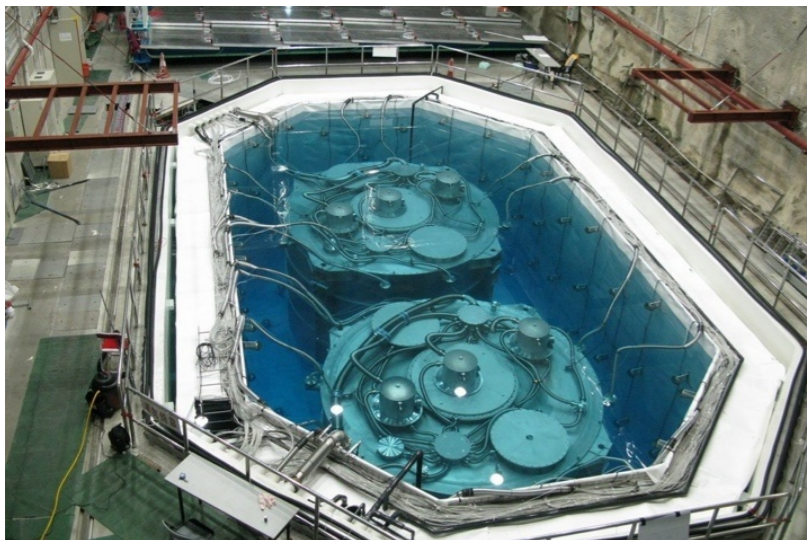

Light-tight cover



Instrumented Veto System

Install PMTs



Tyvek covering

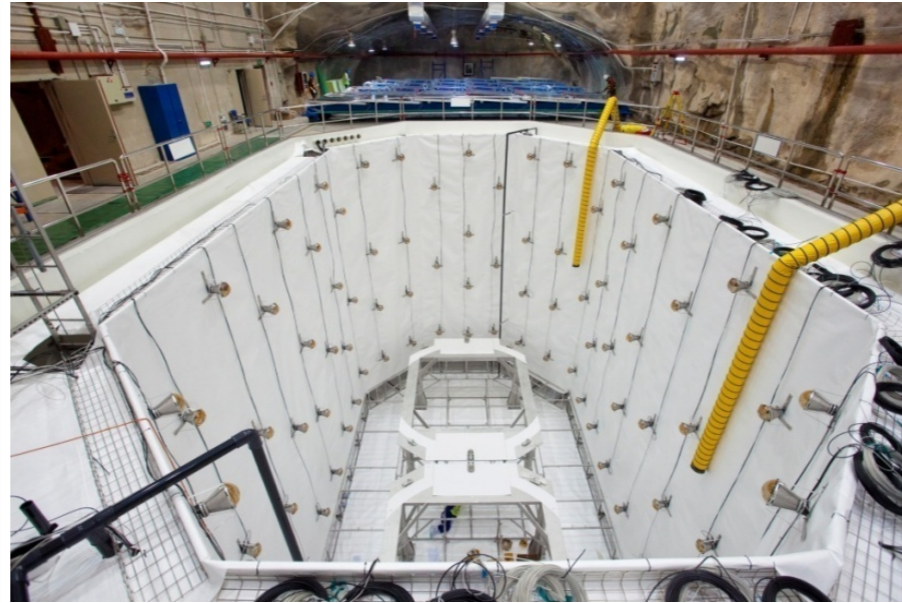

Install AD's

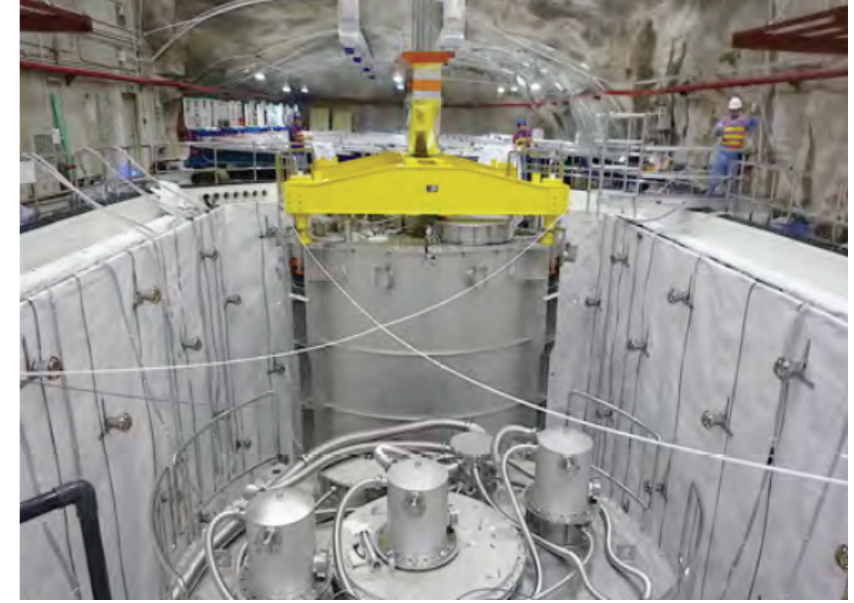

Fill the pool

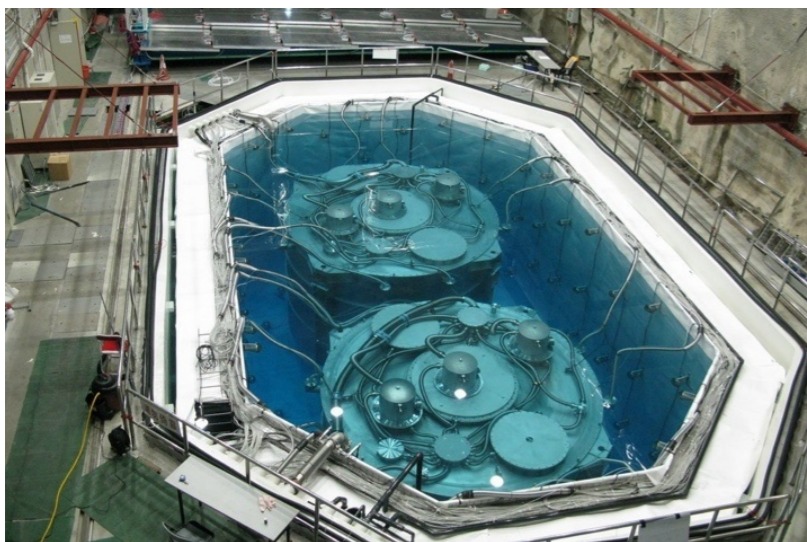

Light-tight cover



Add RPC layer

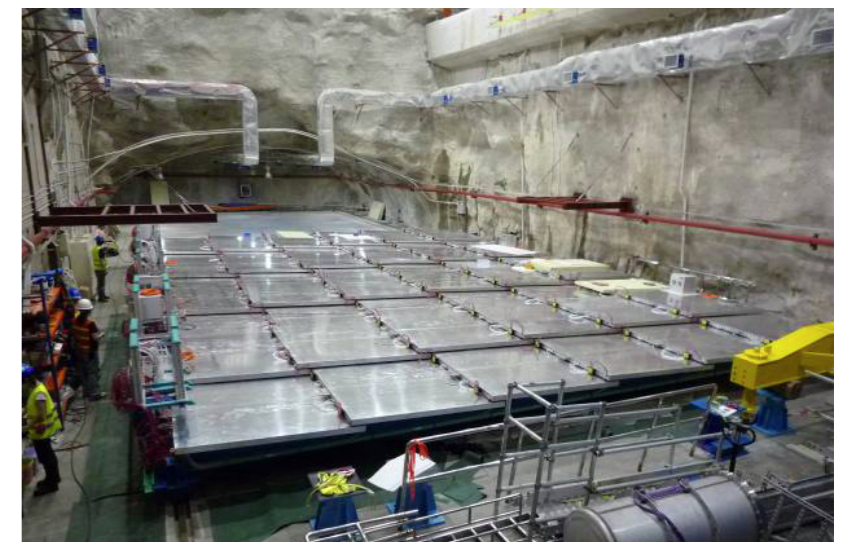

Cosmic Ray Muon Rates ($N_{PMT} > 20$)

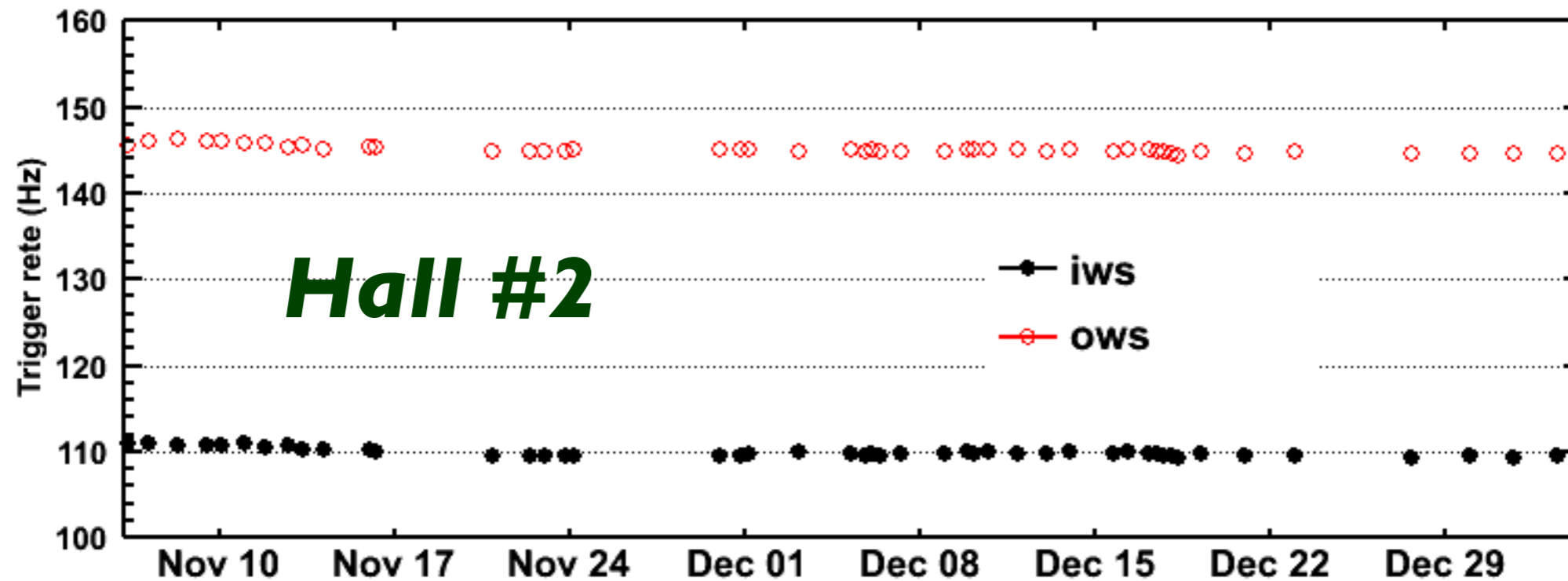
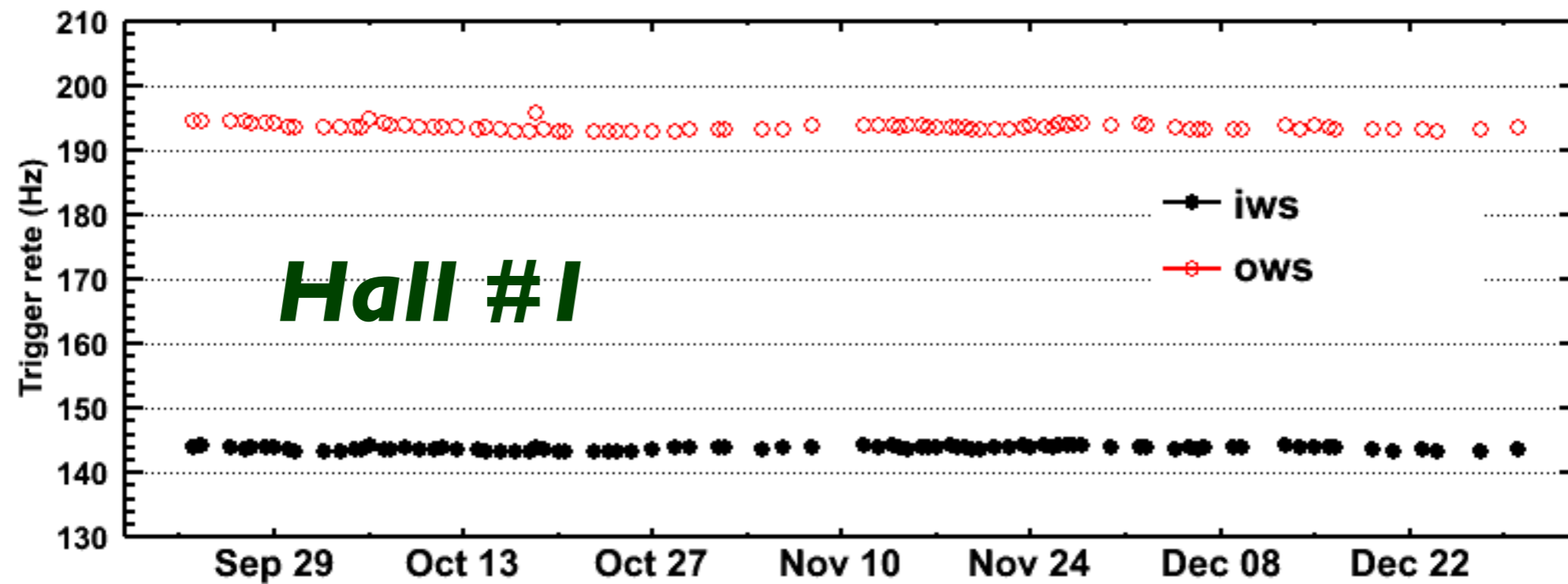

Neutrino Event Detection

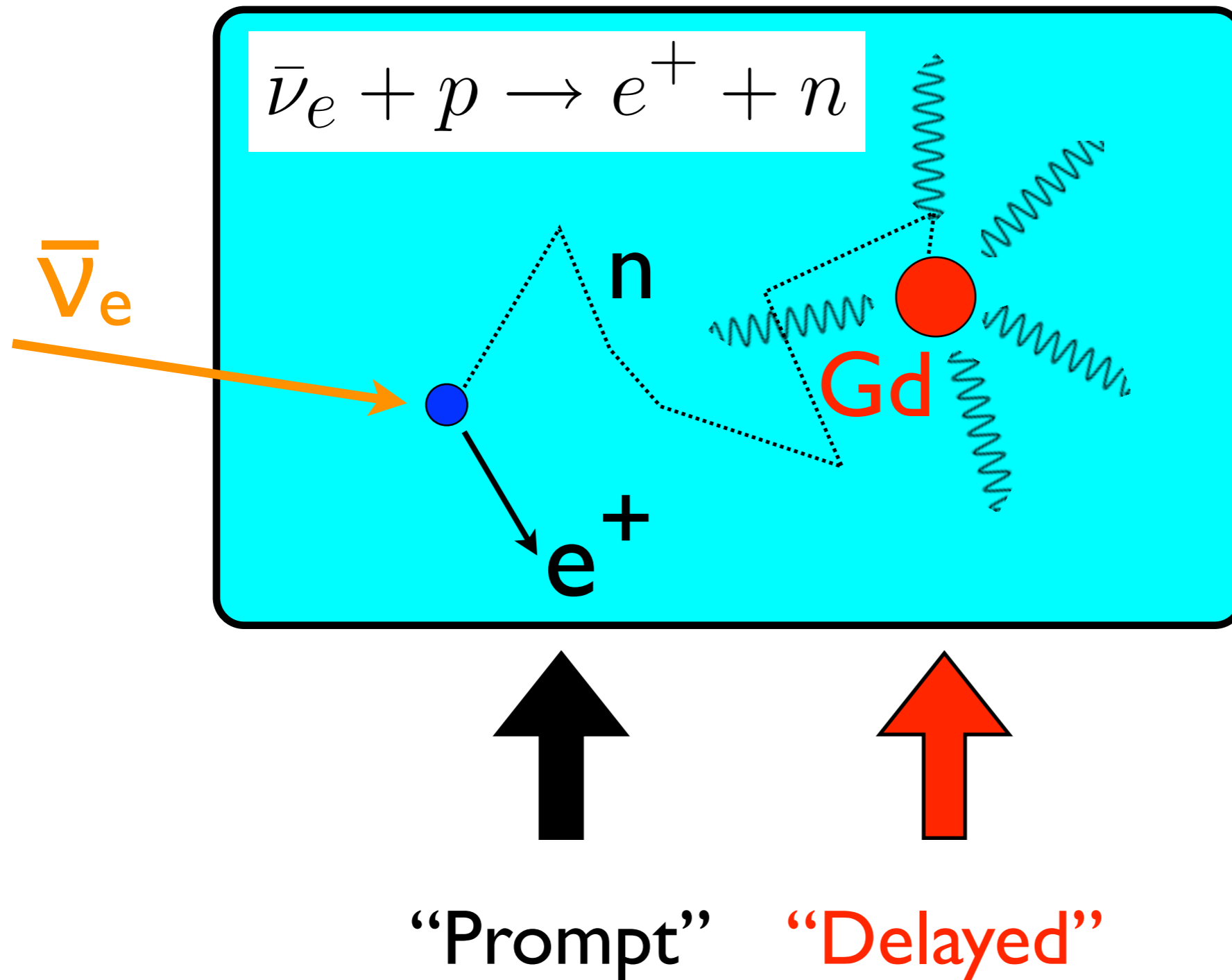

Next few plots will compare AD1 & AD2, both in EH1...

“Prompt” Energy Distribution

All triggers

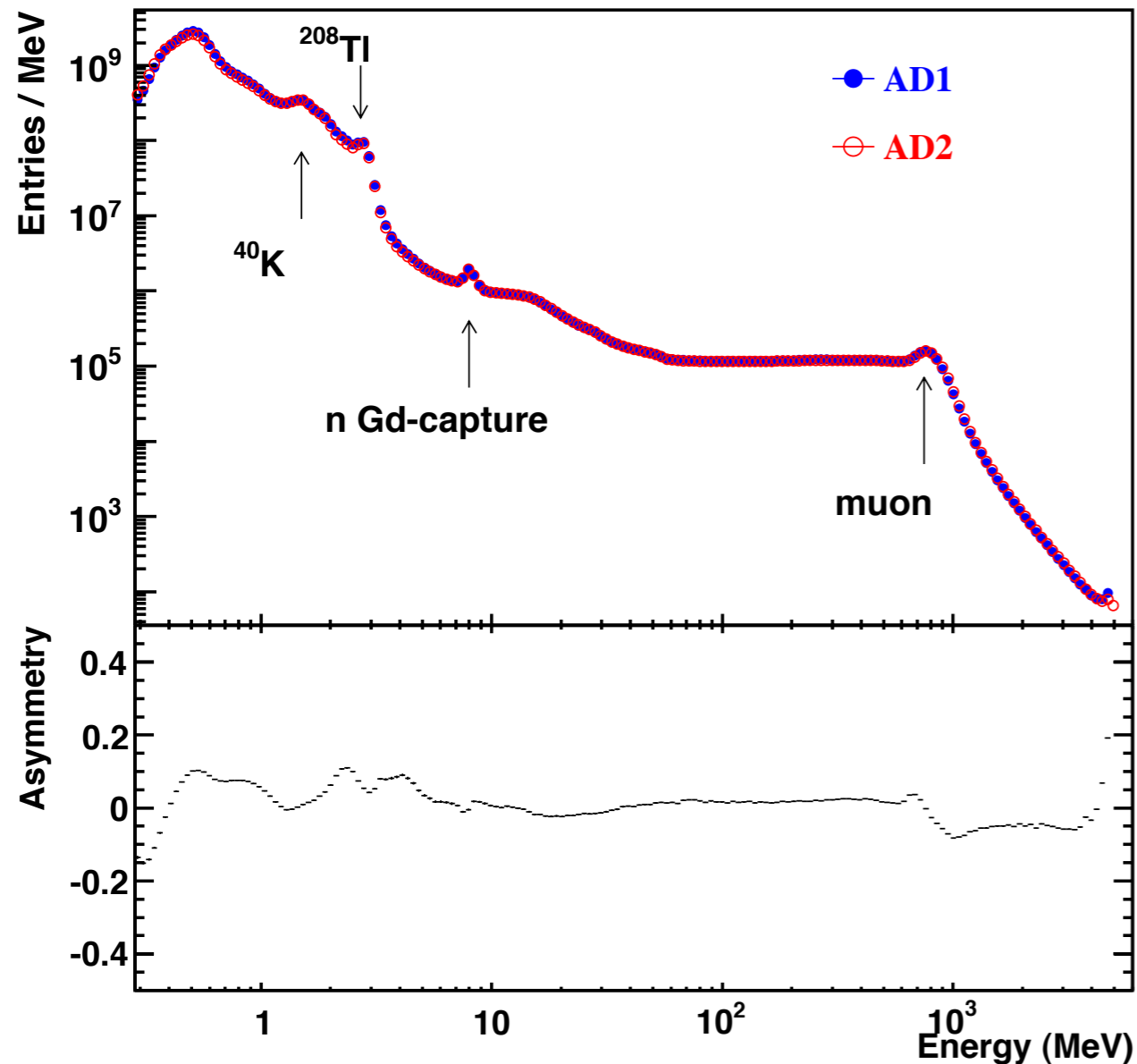

After muon veto

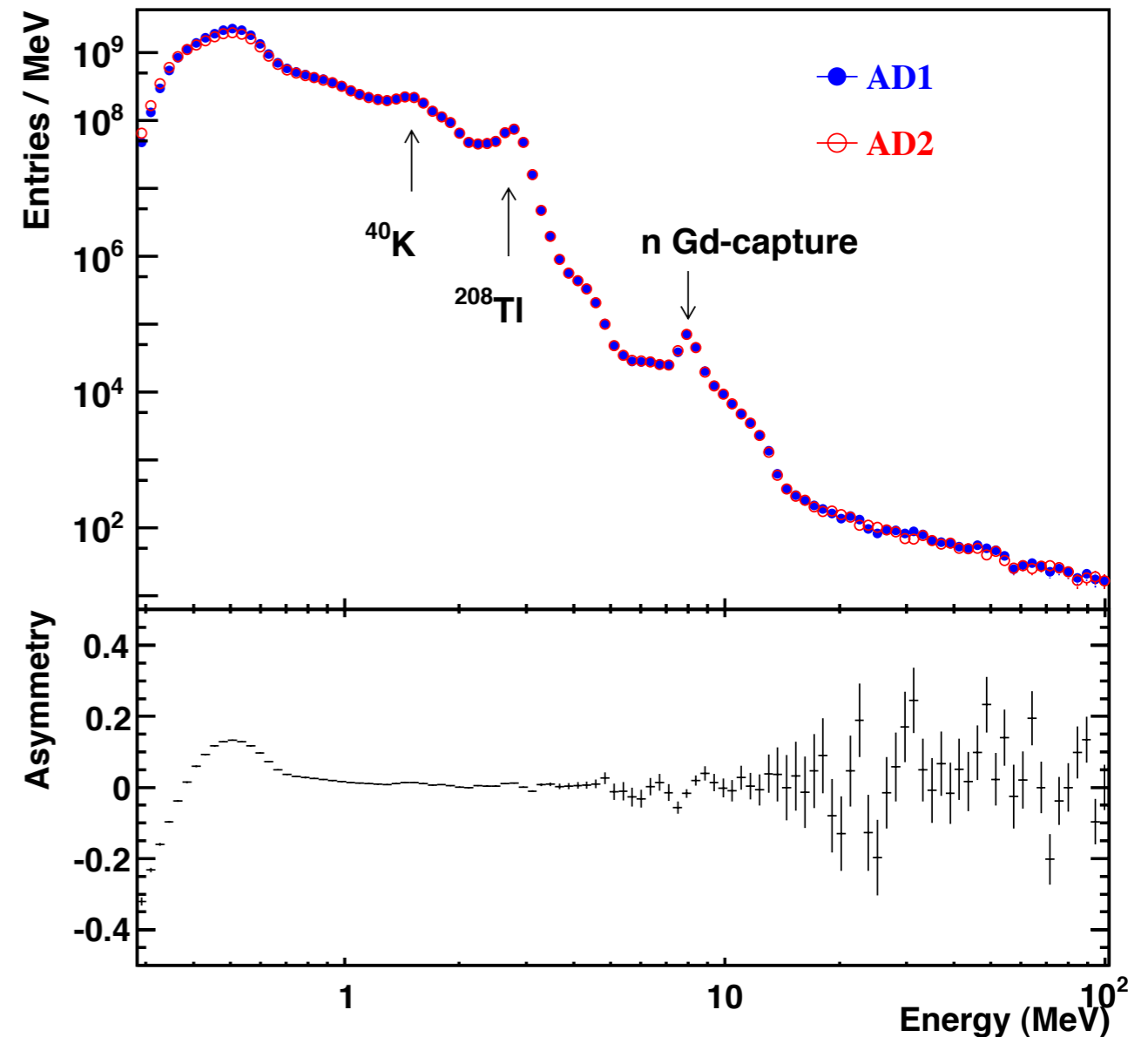

Prompt vs Delayed Energy

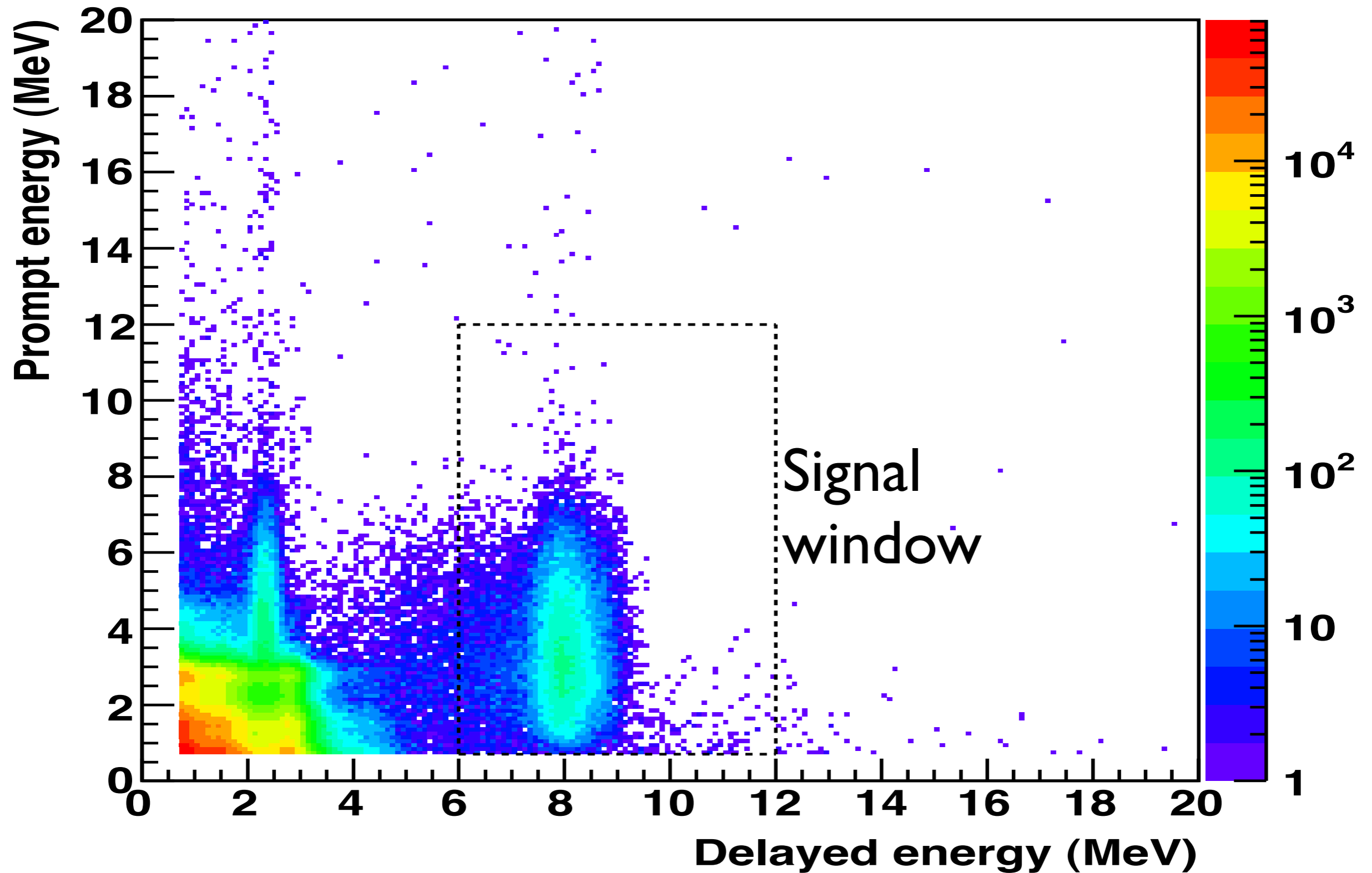

Prompt vs Delayed Energy

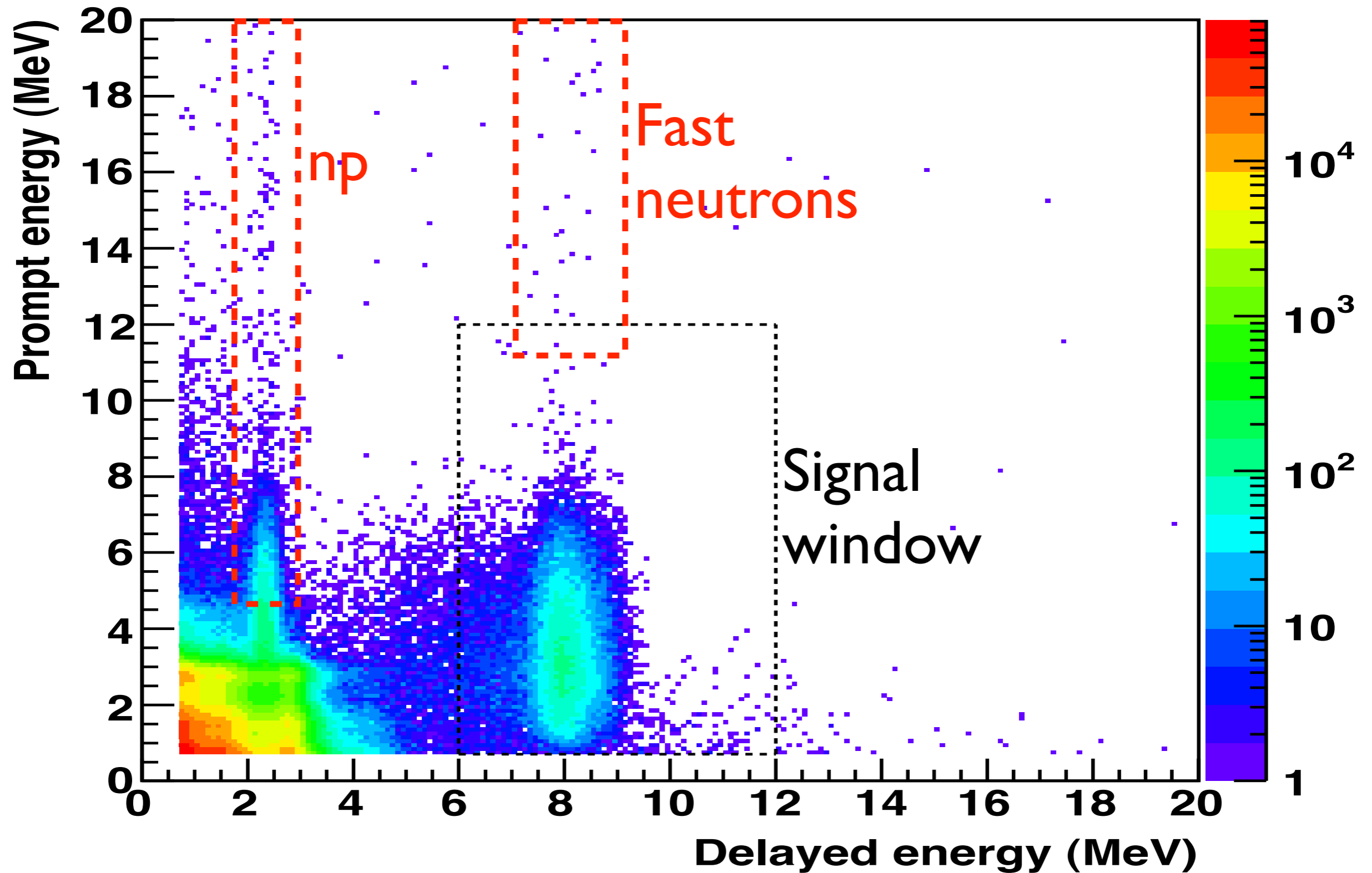

Neutron Capture Time

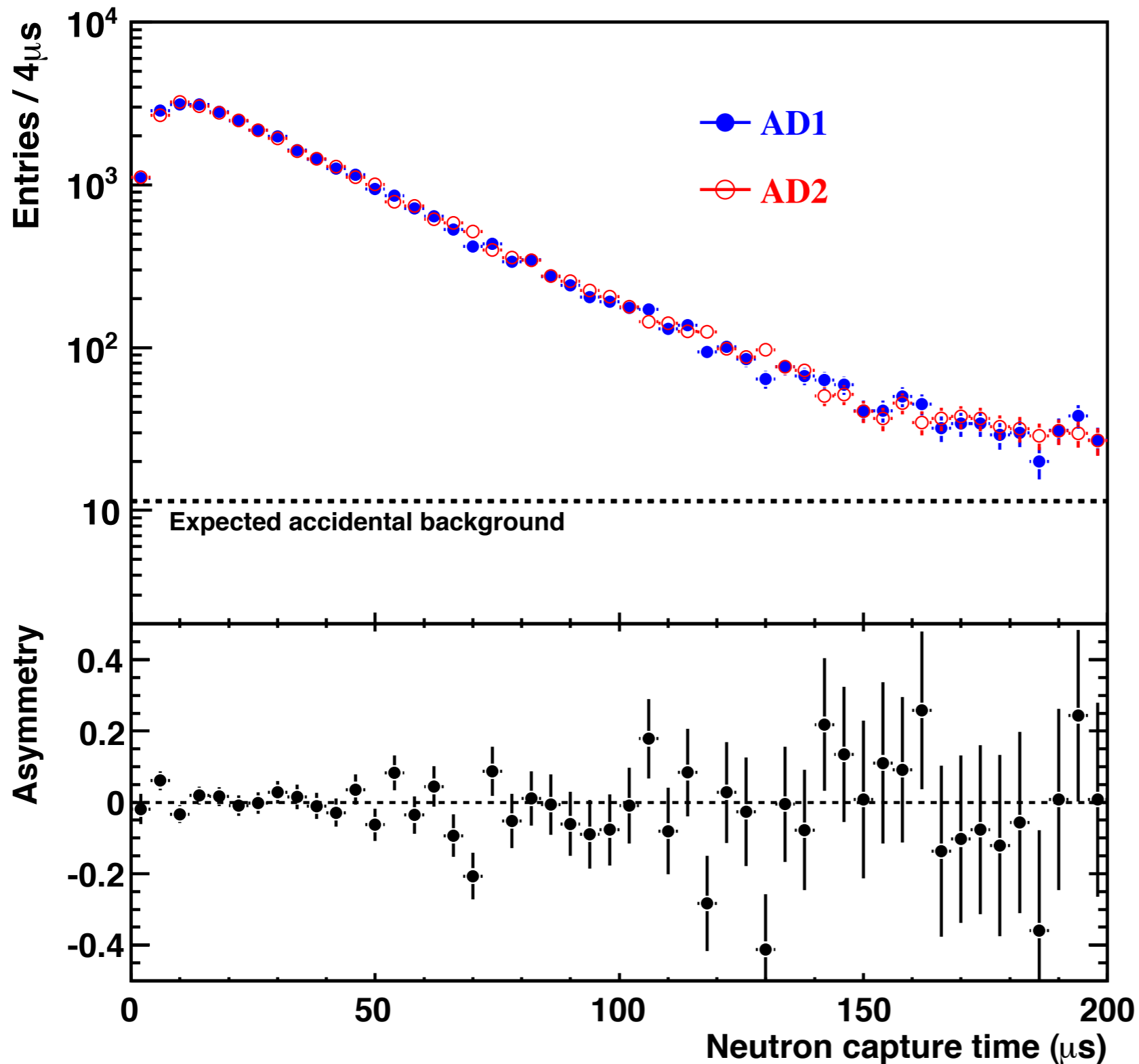

The gadolinium concentration is “identical” for the two detectors.

Inverse Beta Decay Spectra

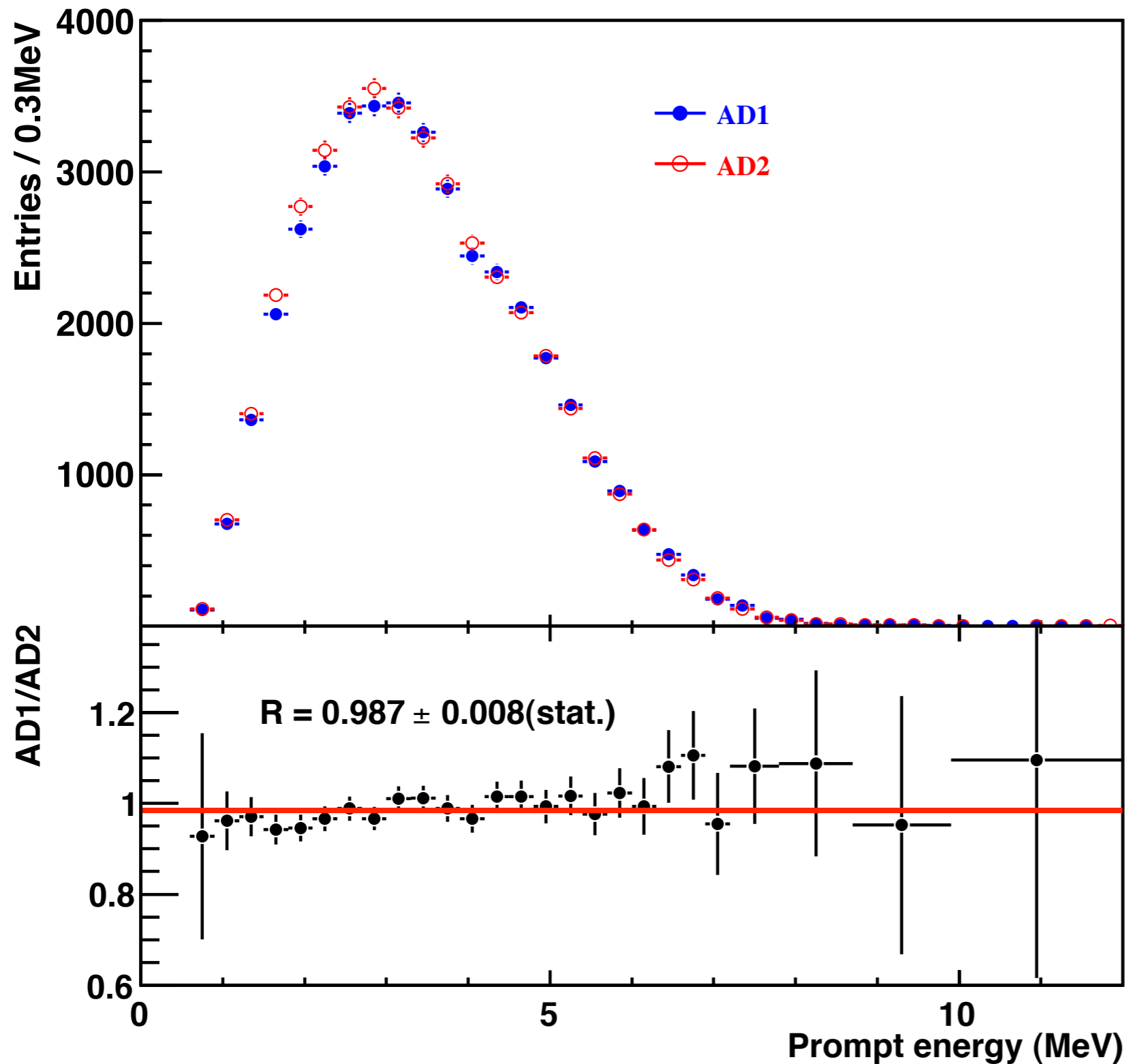

**“Identical”
Antineutrino
Detectors!**

Note: The expected ratio is 0.981 from small differences in distances from the reactor cores.

Rates as a Function of Time

You can see the reactor cores turn off and on.

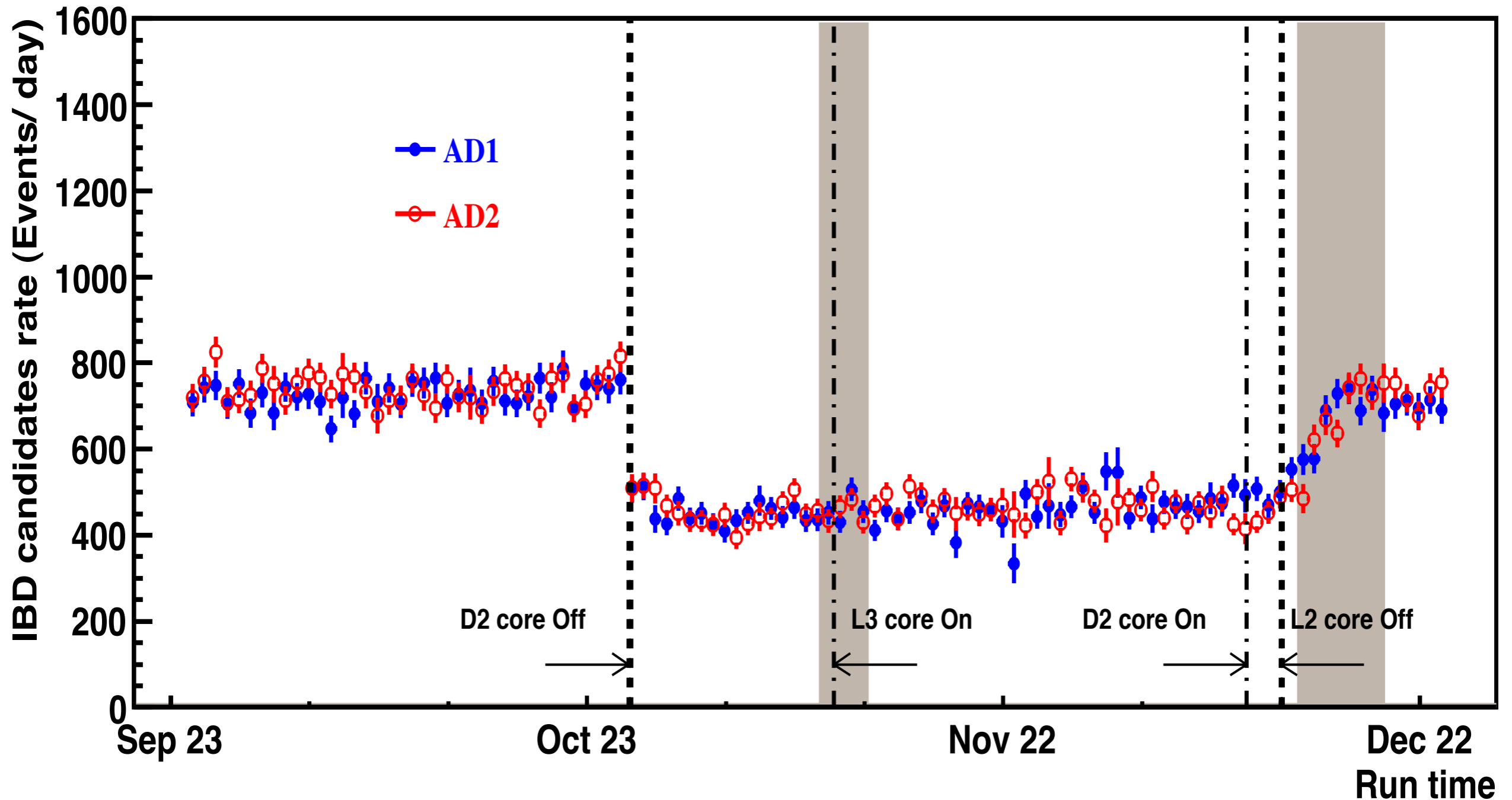

Rates, Backgrounds, and Oscillations

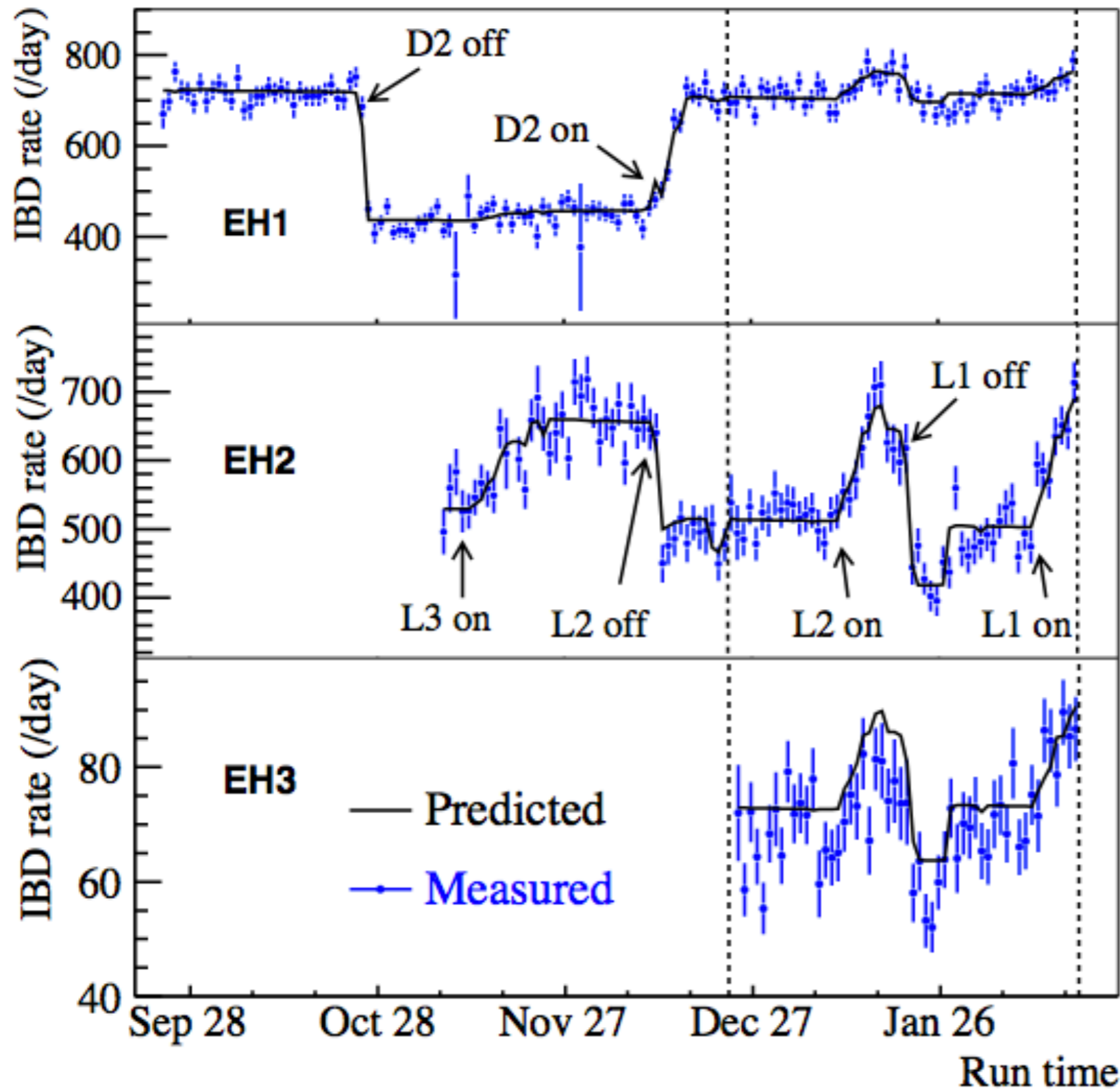

*Near Hall for the
“Daya Bay” cores*

*Near Hall for the
“Ling Ao” cores*

Far Hall

Summary of Rates

	AD1	AD2	AD3	AD4	AD5	AD6
IBD candidates	28935	28975	22466	3528	3436	3452
DAQ live time (days)	49.5530		49.4971	48.9473		
Muon veto time (days)	8.7418	8.9109	7.0389	0.8785	0.8800	0.8952
$\epsilon_\mu \cdot \epsilon_m$	0.8019	0.7989	0.8363	0.9547	0.9543	0.9538
Accidentals (per day)	9.82 ± 0.06	9.88 ± 0.06	7.67 ± 0.05	3.29 ± 0.03	3.33 ± 0.03	3.12 ± 0.03
Fast-neutron (per day)	0.84 ± 0.28	0.84 ± 0.28	0.74 ± 0.44	0.04 ± 0.04	0.04 ± 0.04	0.04 ± 0.04
${}^9\text{Li}/{}^8\text{He}$ (per AD per day)	3.1 ± 1.6		1.8 ± 1.1	0.16 ± 0.11		
Am-C correlated (per AD per day)	0.2 ± 0.2					
${}^{13}\text{C}(\alpha, n){}^{16}\text{O}$ background (per day)	0.04 ± 0.02	0.04 ± 0.02	0.035 ± 0.02	0.03 ± 0.02	0.03 ± 0.02	0.03 ± 0.02
IBD rate (per day)	714.17 ± 4.58	717.86 ± 4.60	532.29 ± 3.82	71.78 ± 1.29	69.80 ± 1.28	70.39 ± 1.28

Signal to
Background

≈ 51

≈ 58

≈ 20

Dominated by accidentals.

Summary of Rates

	AD1	AD2	AD3	AD4	AD5	AD6
IBD candidates	28935	28975	22466	3528	3436	3452
DAQ live time (days)	49.5530		49.4971	48.9473		
Muon veto time (days)	8.7418	8.9109	7.0389	0.8785	0.8800	0.8952
$\epsilon_\mu \cdot \epsilon_m$	0.8019	0.7989	0.8363	0.9547	0.9543	0.9538
Accidentals (per day)	9.82 ± 0.06	9.88 ± 0.06	7.67 ± 0.05	3.29 ± 0.03	3.33 ± 0.03	3.12 ± 0.03
Fast-neutron (per day)	0.84 ± 0.28	0.84 ± 0.28	0.74 ± 0.44	0.04 ± 0.04	0.04 ± 0.04	0.04 ± 0.04
${}^9\text{Li}/{}^8\text{He}$ (per AD per day)	3.1 ± 1.6		1.8 ± 1.1	0.16 ± 0.11		
Am-C correlated (per AD per day)	0.2 ± 0.2					
${}^{13}\text{C}(\alpha, n){}^{16}\text{O}$ background (per day)	0.04 ± 0.02	0.04 ± 0.02	0.035 ± 0.02	0.03 ± 0.02	0.03 ± 0.02	0.03 ± 0.02
IBD rate (per day)	714.17 ± 4.58	717.86 ± 4.60	532.29 ± 3.82	71.78 ± 1.29	69.80 ± 1.28	70.39 ± 1.28

Signal to
Background

≈ 51

≈ 58

≈ 20

Dominated by accidentals.

The importance of overburden...

${}^9\text{Li}/{}^8\text{He}$ Backgrounds

“Beta-delayed neutron” emitters mimic our signal!

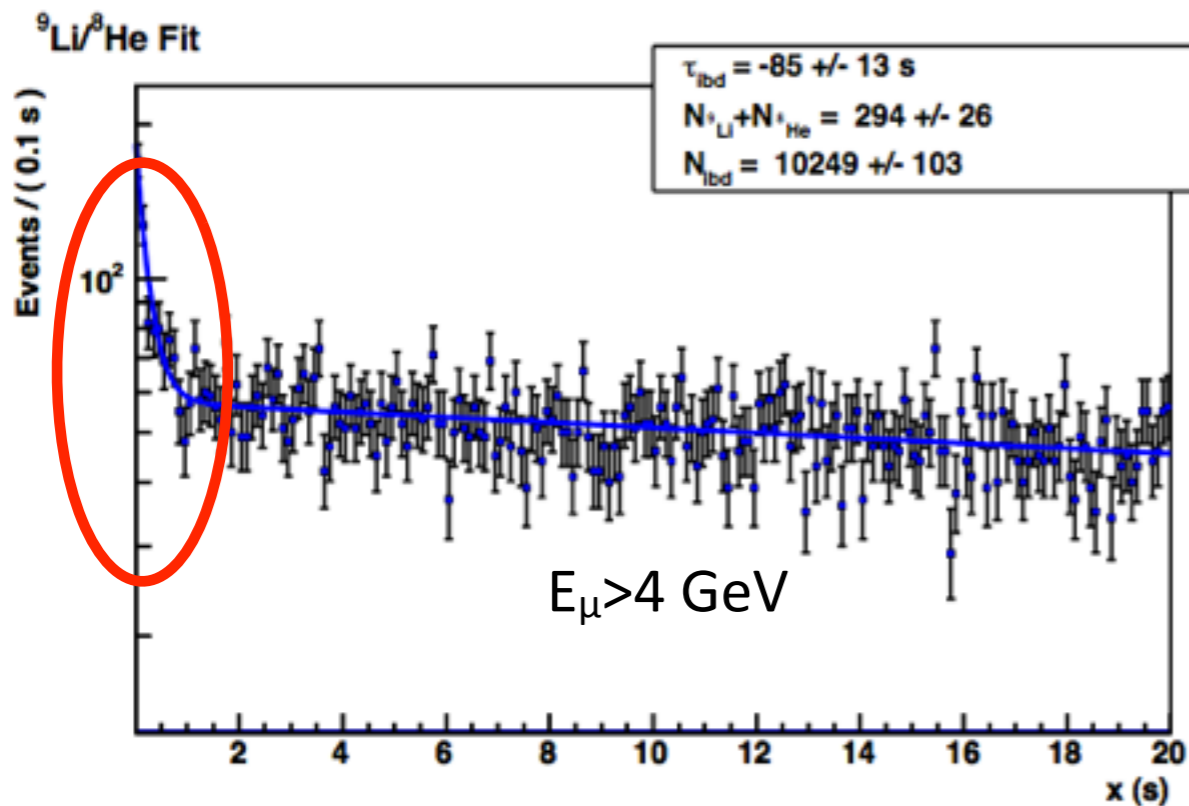

178/119 ms half-life decays following energetic muon events must be extrapolated and subtracted.

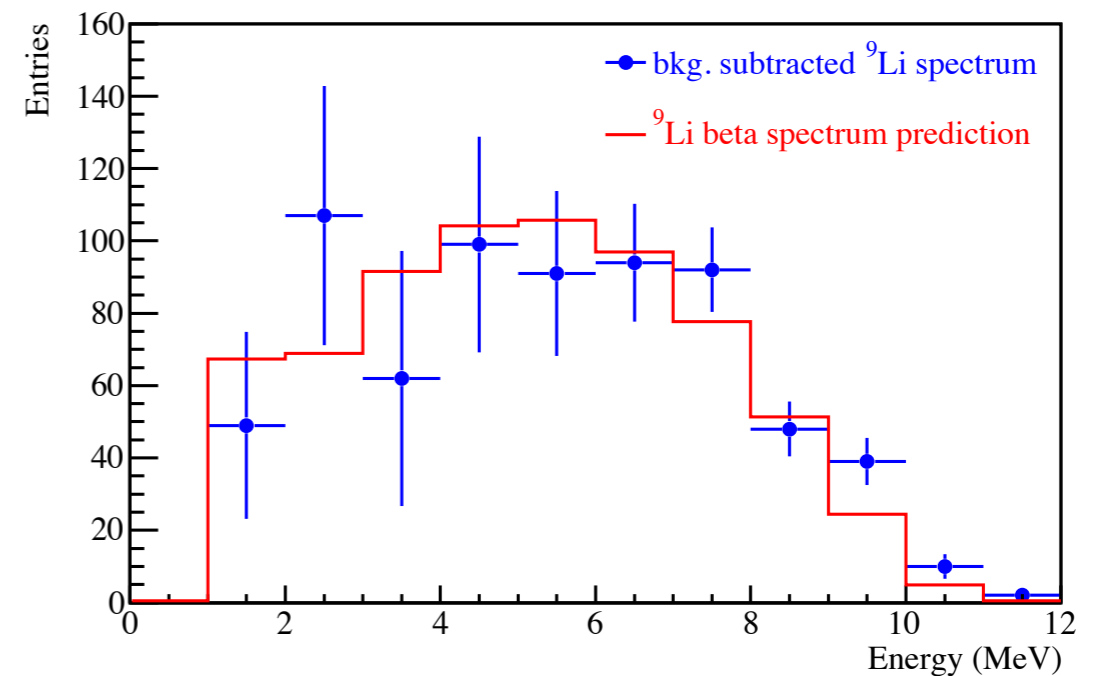
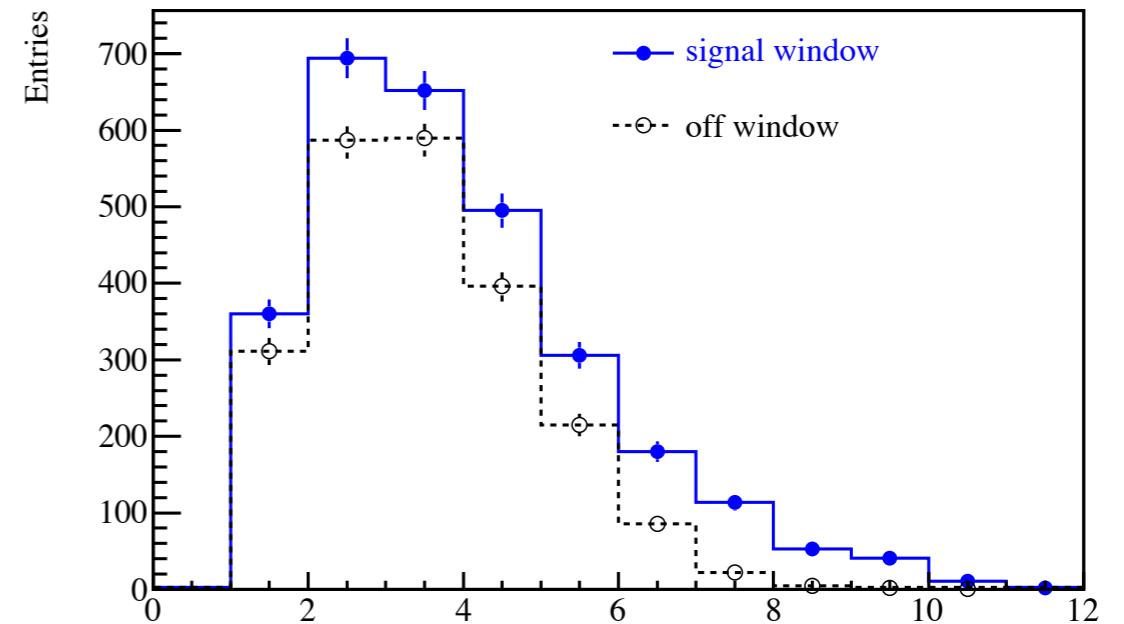

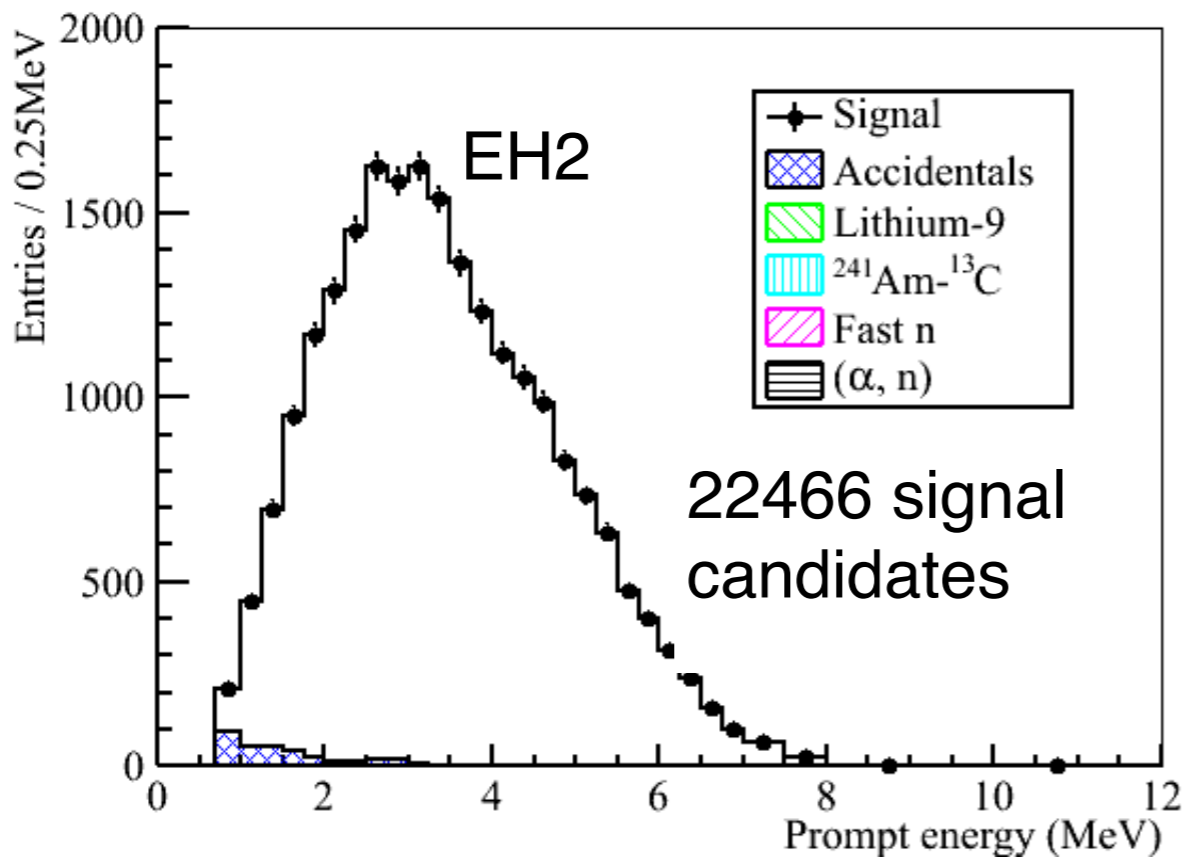
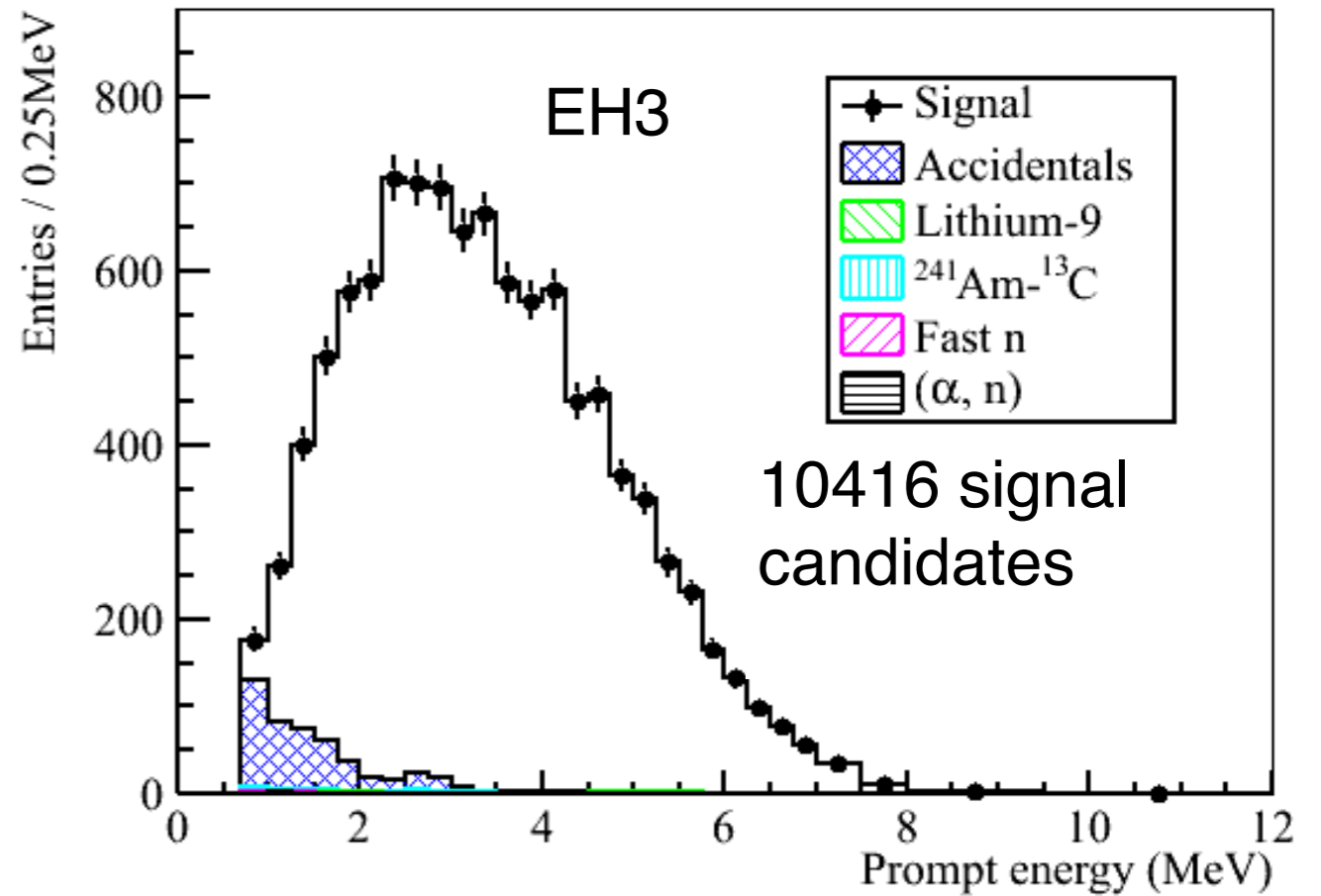
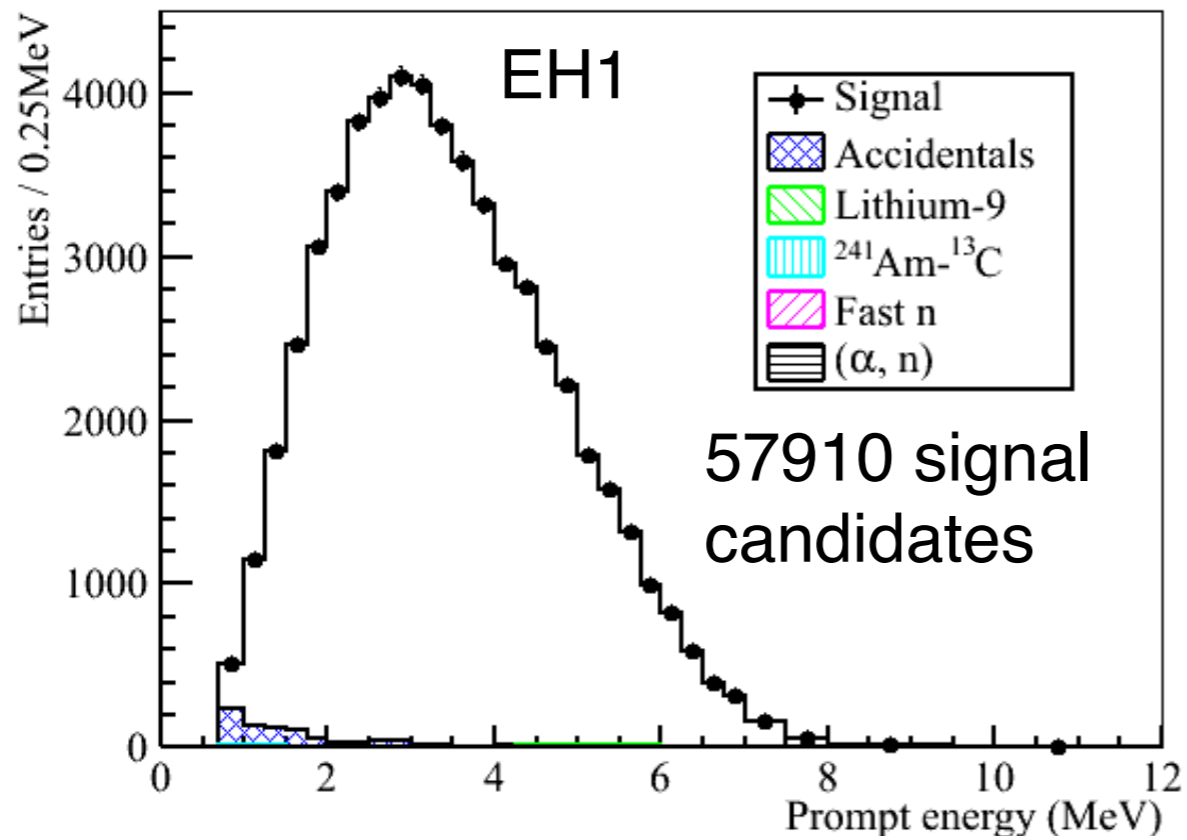

Efficiencies and Systematic Uncertainties

Detector			
	Efficiency	Correlated	Uncorrelated
Target Protons		0.47%	0.03%
Flasher cut	99.98%	0.01%	0.01%
Delayed energy cut	90.9%	0.6%	0.12%
Prompt energy cut	99.88%	0.10%	0.01%
Multiplicity cut		0.02%	<0.01%
Capture time cut	98.6%	0.12%	0.01%
Gd capture ratio	83.8%	0.8%	<0.1%
Spill-in	105.0%	1.5%	0.02%
Livetime	100.0%	0.002%	<0.01%
Combined	78.8%	1.9%	0.2%

Reactor			
Correlated		Uncorrelated	
Energy/fission	0.2%	Power	0.5%
IBD reaction/fission	3%	Fission fraction	0.6%
		Spent fuel	0.3%
Combined	3%	Combined	0.8%

$$\sin^2 2\theta_{13} = 0.092 \pm 0.016 \text{ (stat)} \pm 0.005 \text{ (syst)}$$

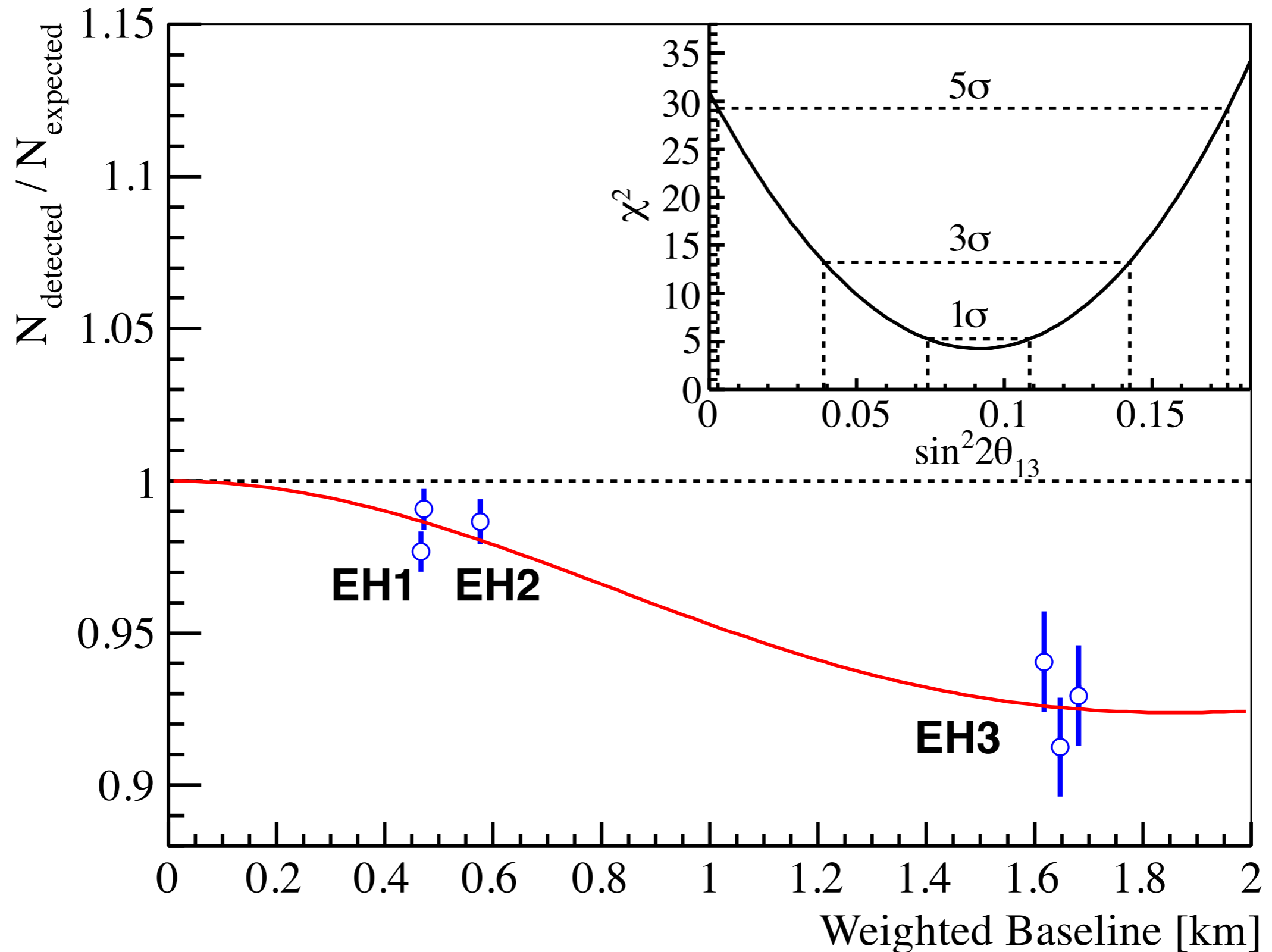

Spectrum Shape

Analysis in progress.

Next steps rely on careful energy calibration of all antineutrino detectors.

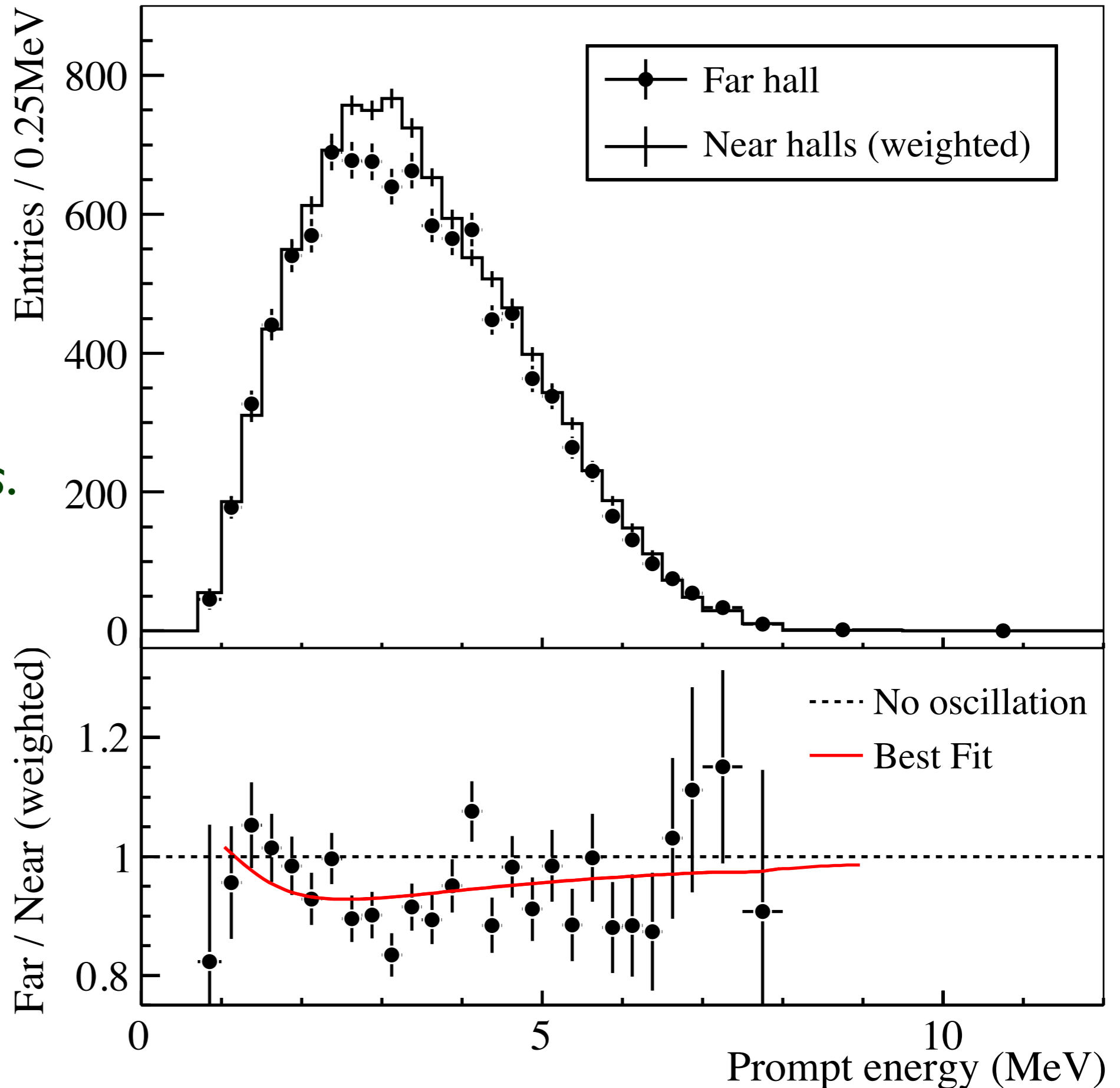

Future Plans & Next Steps

Daya Bay:

Data taking in progress.

Add last two AD's this summer.

Continue data taking, improve energy scale calibrations, beat down systematic errors.

Uncertainty Evolution of Daya Bay ($\sin^2 2\theta_{13}=0.092$)

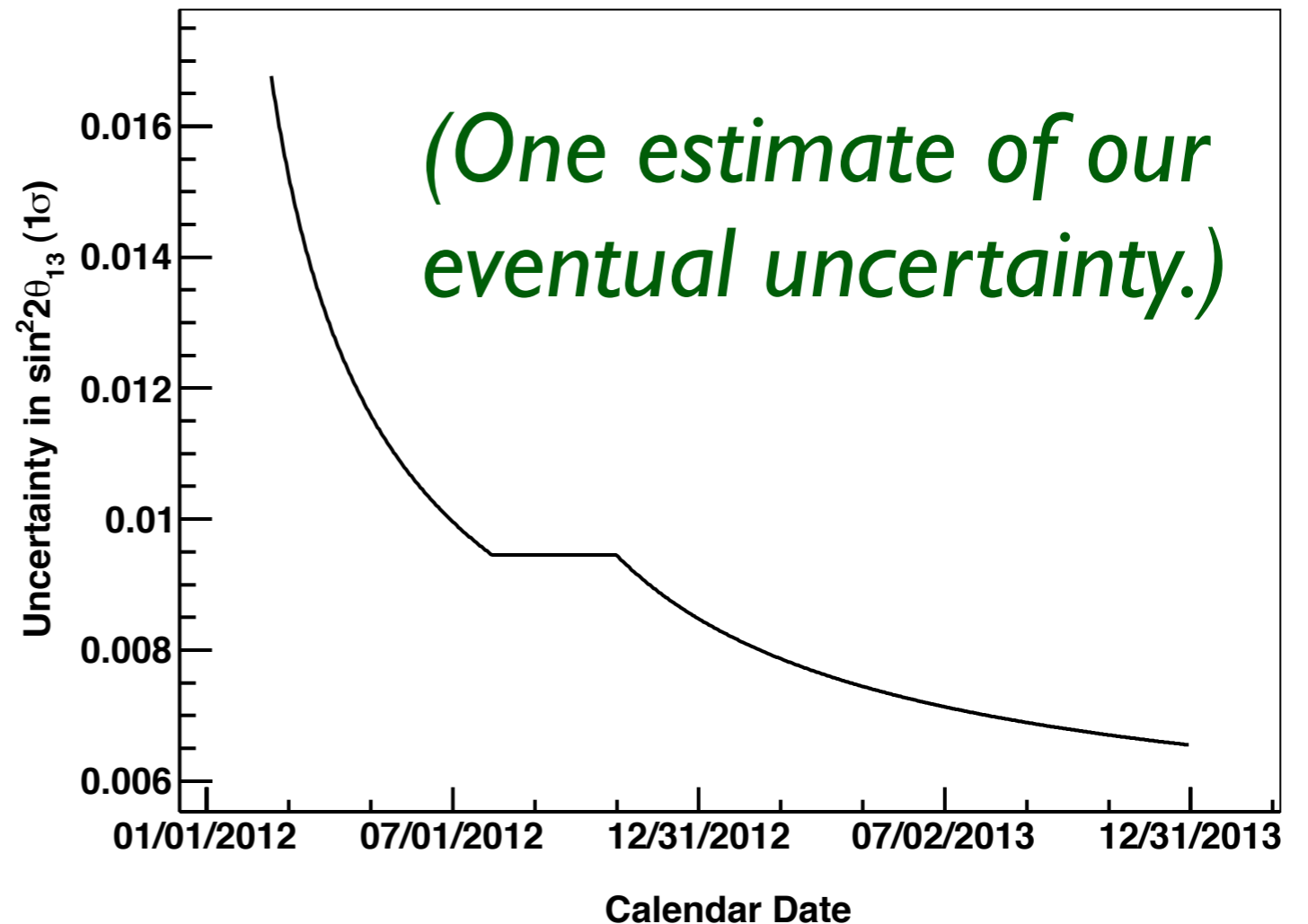

And looking for creative new analyses.

Other Reactor Experiments

RENO confirms our result:

$$\sin^2 2\theta_{13} = 0.113 \pm 0.013 \text{ (stat)} \pm 0.019 \text{ (syst)}$$

Submitted to Physical Review Letters.

Double Chooz preparing now to install their near detector this summer.

Implications for the Field

We now know the value of θ_{13}

Better planning is now possible for the next phase of neutrino/antineutrino appearance experiments.

The value of θ_{13} is larger than we expected

The appearance signal will be larger and the electron-like backgrounds will be less critical.

Experiments on the Horizon

T2K: Has recovered from the earthquake.

Data taking “due to start in March 2012.”

NOvA: Should be taking data by next year.

Larger signal will allow larger coverage in parameter space for *CP* violation.

LBNE: Evaluating options for moving forward.

Major meeting at FermiLab next week.

Thank You!

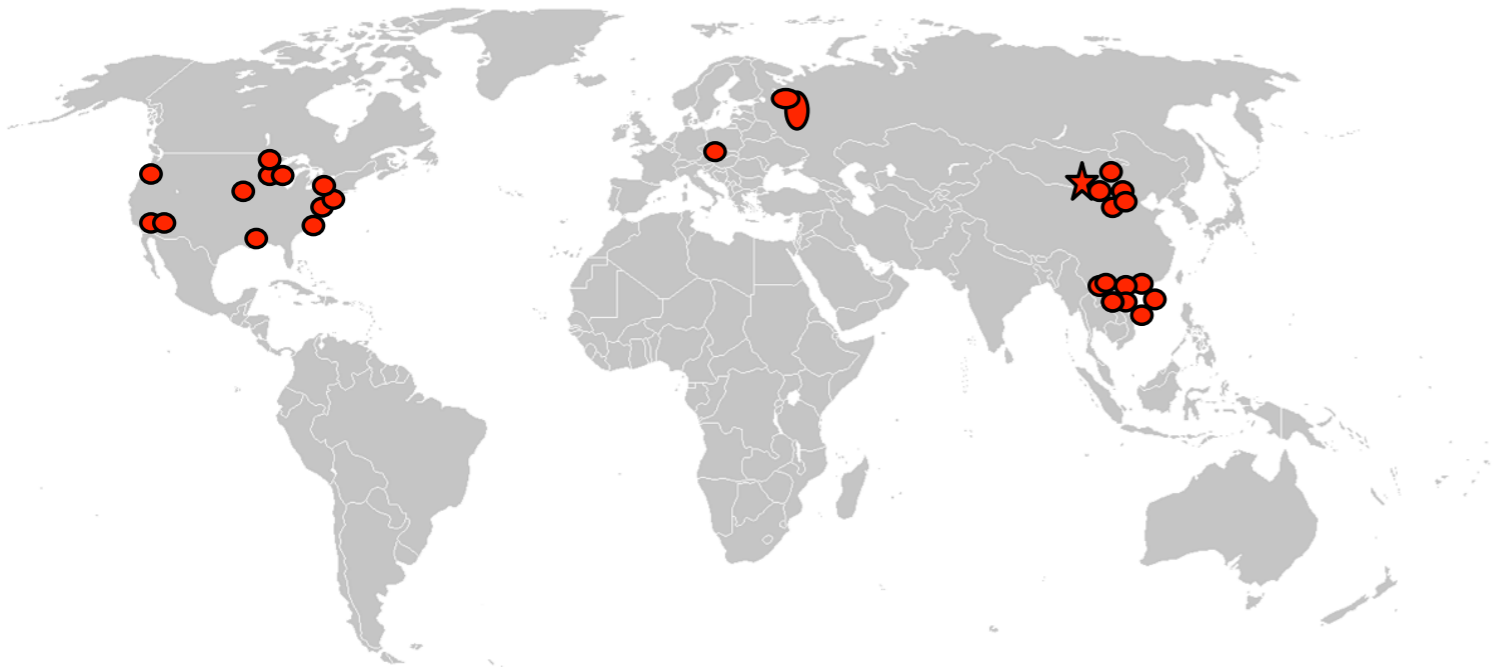

Asia (20)

IHEP, Beijing Normal Univ., Chengdu Univ. of Sci and Tech, CGNPG, CIAE, Dongguan Polytech, Nanjing Univ., Nankai Univ., NCEPU, Shandong Univ., Shanghai Jiao Tong Univ., Shenzhen Univ., Tsinghua Univ., USTC, Zhongshan Univ., Univ. of Hong Kong, Chinese Univ. of Hong Kong, National Taiwan Univ., National Chiao Tung Univ., National United Univ.

North America (16)

Brookhaven Natl' Lab, Cal Tech, Cincinnati, Houston, Illinois Institute of Technology, Iowa State, Lawrence Berkeley Natl' Lab, Princeton, Rensselaer Polytech, UC Berkeley, UCLA, Wisconsin, William & Mary, Virginia Tech, Illinois, Siena College

Europe (2)

Charles Univ., Dubna

~230 collaborators

